

**Finisher SR4120, Booklet Finisher
SR4130**

Machine Code: D3CG, D3CH

Field Service Manual

Ver 1.10









Latest Release: Jan, 2017

Initial Release: Oct, 2016

Copyright (c) 2016 - 2017 Ricoh Co.,Ltd.

Symbols, Abbreviations

This manual uses several symbols and abbreviations. The meaning of those symbols and abbreviations are as follows:

Symbol	What it means
	Clip ring
	Screw
	Screw: Blue
	Connector
	Clamp
	E-ring
	Flat Flexible Cable
	Timing Belt
	Hook (sensors)
SEF	Short Edge Feed
LEF	Long Edge Feed
K	Black
C	Cyan
M	Magenta
Y	Yellow
B/W, BW	Black and White
FC	Full color

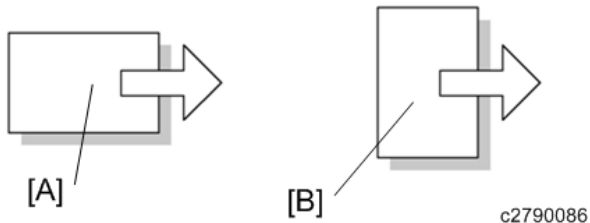

[A] Short Edge Feed (SEF)

[B] Long Edge Feed (LEF)

Table of Contents

1. Replacement and Adjustment.....	3
Covers.....	3
Rear Upper Cover, Rear Lower Cover, Upper Cover	3
Front Cover, Front Left Side Cover	5
Paper Guide Cover	6
Paper Exit Cover	8
Lower Tray.....	11
Proof Tray	11
Upper Tray	12
End Fence (SR4130)	12
End Fence (SR4120)	13
Paper Guide Unit.....	14
Boards.....	17
Main Board.....	17
Main Motors	19
Corner Stapling Unit	19
Paper Exit Gate Motor.....	24
Leading Edge Guide Motor.....	24
Trailing Edge Pressure Plate Motor	25
Stacking Roller Motor.....	25
Feed Out Motor	26
Jogger Motor	26
Paper Guide Motor	27
Sensors.....	29
Shift Tray Paper Sensor.....	29
Trailing Edge Pressure Plate HP Sensor	29
Stacking Roller HP Sensor.....	30
Staple Tray Paper Sensor	32
Paper Guide HP Sensor	33
Booklet Unit Motors.....	35
Booklet Stapler Unit.....	35
Press Fold Motor	37
Booklet Jogger Motor.....	40
Stapler Unit.....	41
Stapler Unit	41
Punch Unit.....	44
Fold Adjustments	47

Flat Fold Roller Alignment	47
Adjusting the Folding Speed	49
Flat Fold Booklet Unit Home Position Adjustment	49
Paper Guide Unit	52
Paper Exit Cover, Optional Output Jogger Unit.....	52
Paper Guide Unit.....	57
Paper Guide Unit Sensor	60
Paper Guide Motor	61
2. Detailed Descriptions	63
Overview	63
Layout	63
Operation Details.....	71
Shift Operation (Shift Transport)	71
Pre-stack Operation (In Corner Stapling).....	71
Pre-stack Operation (Booklet Stapling).....	72
Upper Tray Shift Drive / Limit Sensor / Full Sensor	73
Pull-in Roller / Paper Stack Holder	75
Corner Stapling	77
Saddle Stapling (Booklet Stapling)	82

1. Replacement and Adjustment

Covers

Rear Upper Cover, Rear Lower Cover, Upper Cover

1. Rear upper cover [A] (⊗ x 2)

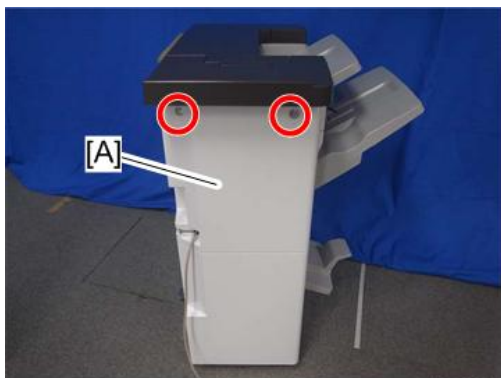

d1351253

2. Rear lower cover [A] (⊗ x 2)

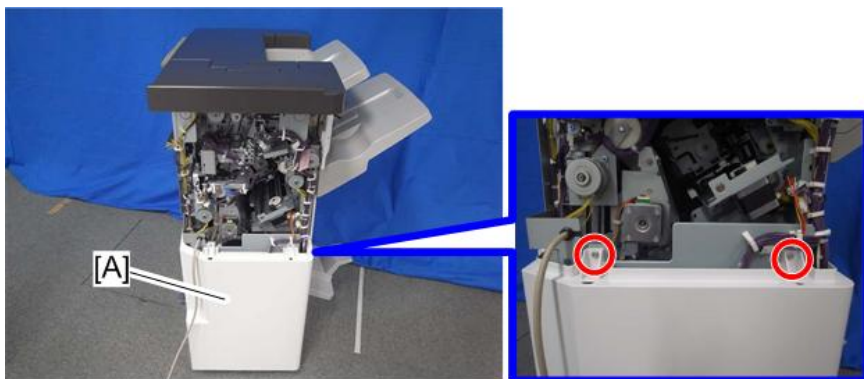

d1351254

1.Replacement and Adjustment

3. Open the front door [A], and remove the screws of the upper cover. (🔩 x 5)

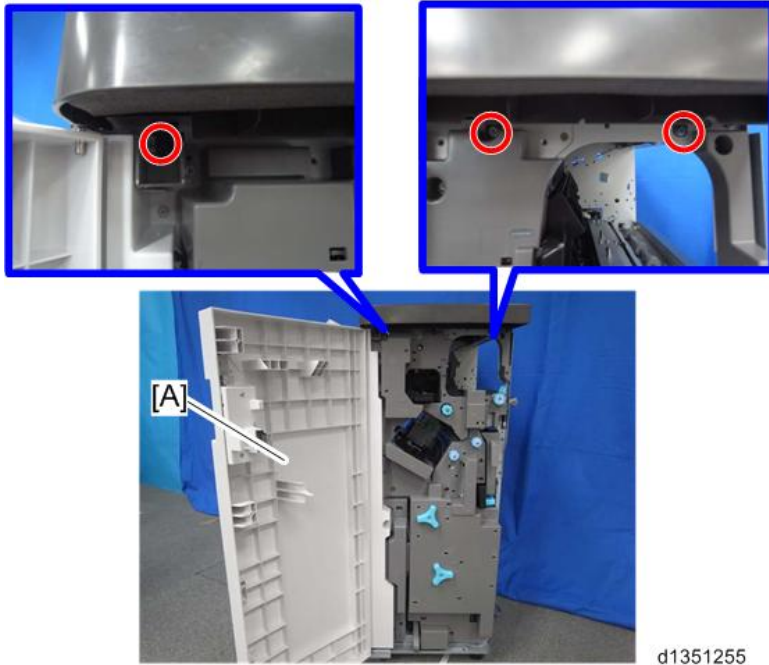

4. Upper cover [A] (🔩 x 2, ▼x 2)

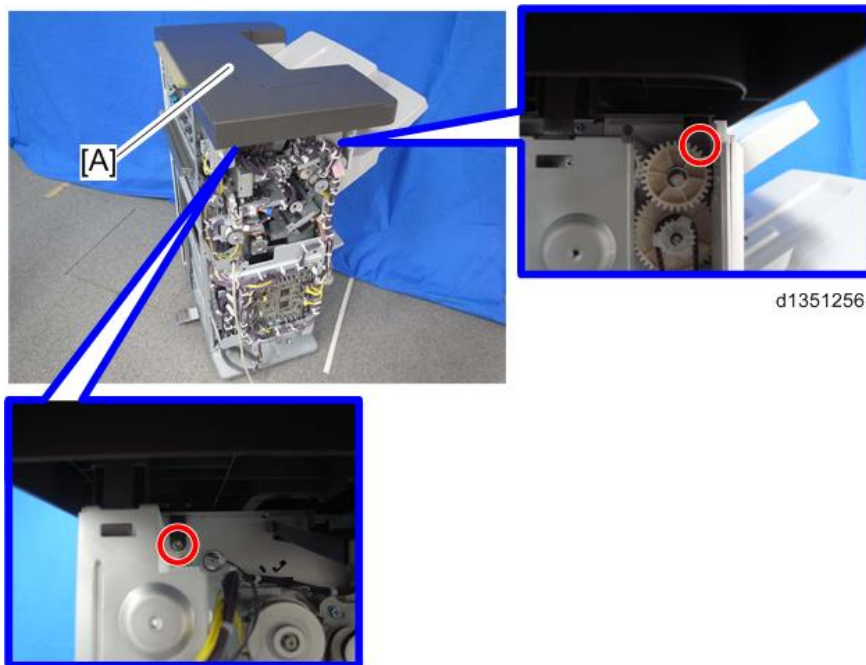

5. Check the positions of the bosses and hooks before removing the upper cover.

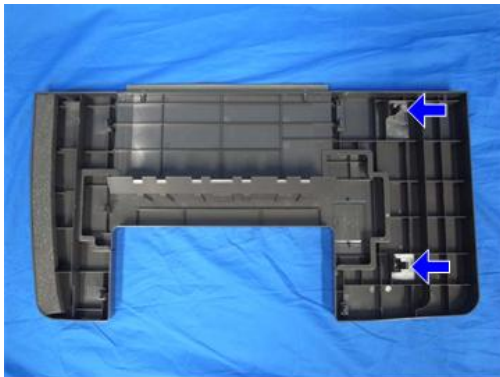

d1351257

6. When the upper cover is re-attached, tighten the screws on the right side in the order shown below: 1 > 2 > 3.



d135e2008

Front Cover, Front Left Side Cover

1. Open the front door [A], and then remove the front door bracket [B]. (🔑 x 1)
2. Front door [A]

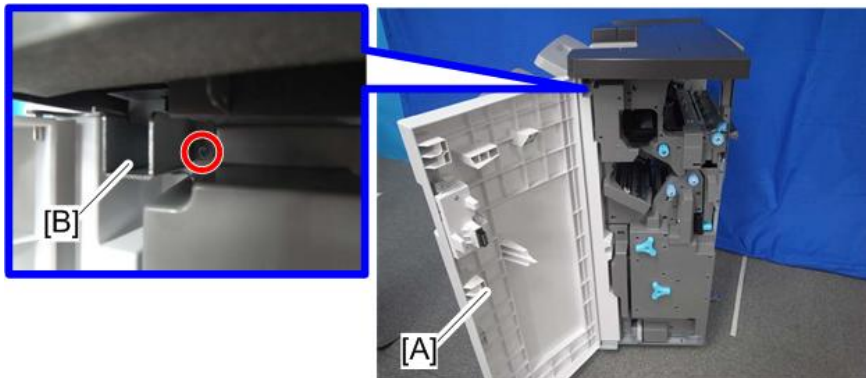

d1351258

1.Replacement and Adjustment

3. Front left side cover [A] (🔩 x 2)

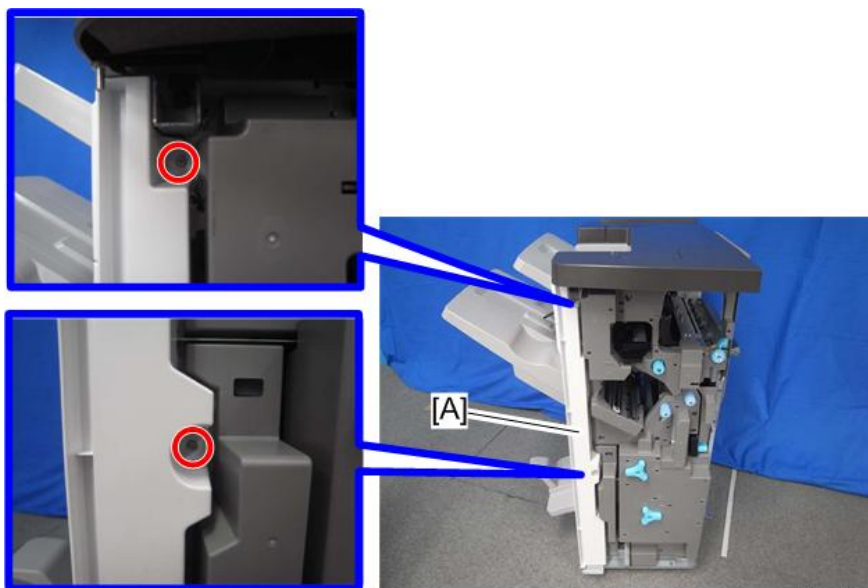

d1351259

Paper Guide Cover

1. Remove rear upper cover [A] (🔩 x1).

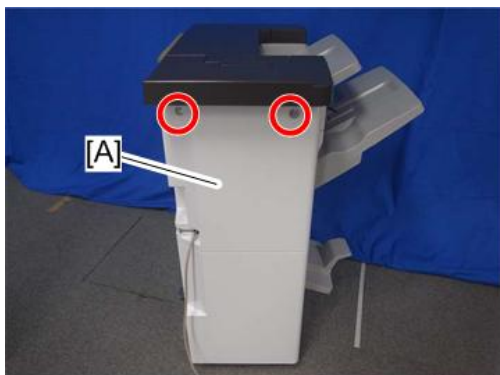

d1351253

2. Remove shift tray [A] (🔩 x1).



d1351777

3. Push the guides in to the center.

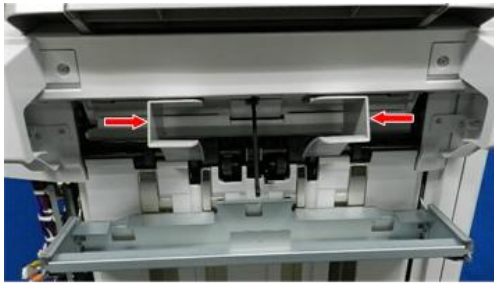

d3cjc1004

4. Remove rear paper guide cover [A] (⊙ x1).

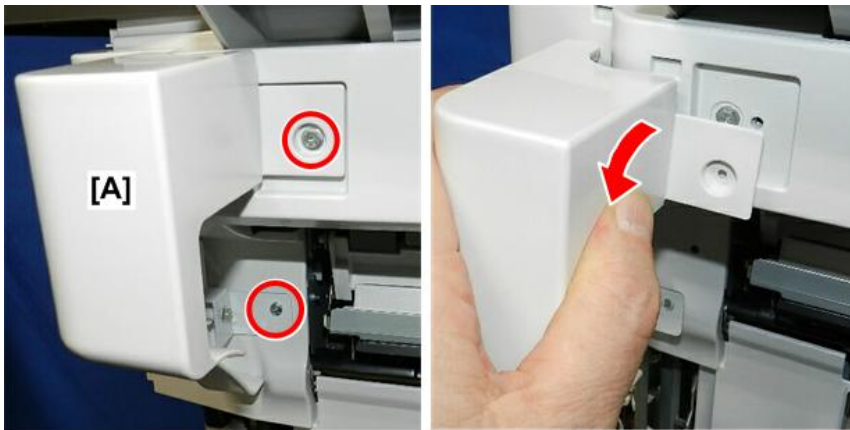

d3cjc1005a

5. Remove front paper guide cover [A] (⊙ x2).

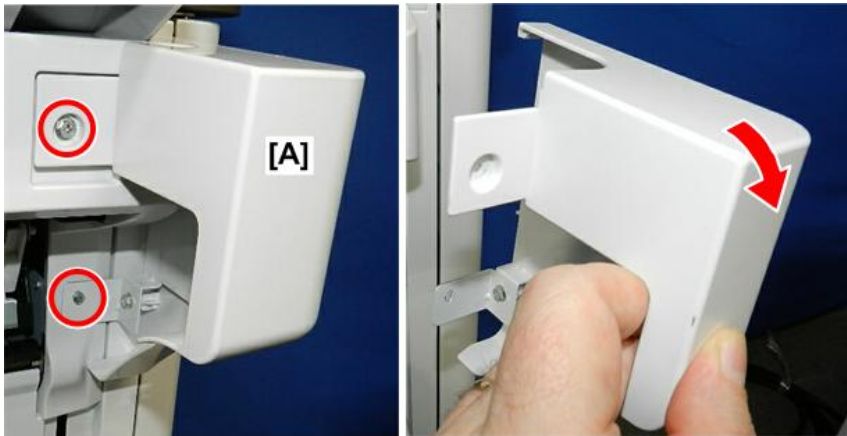

d3cjc1006a

1.Replacement and Adjustment

6. Remove paper guide cover [A] screws (🔩 x2).



d3cjc1007a

7. Disconnect the front tab, and then remove the cover.

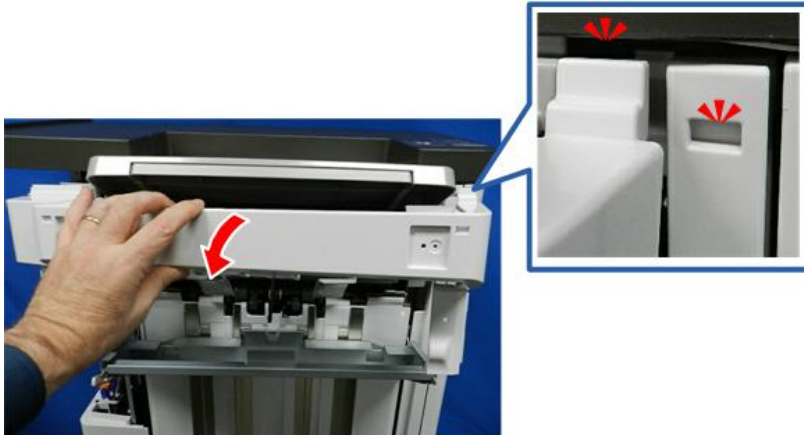

d3cjc1008a

Paper Exit Cover

1. Disconnect the finisher from the main frame.
2. Remove the rear cover.

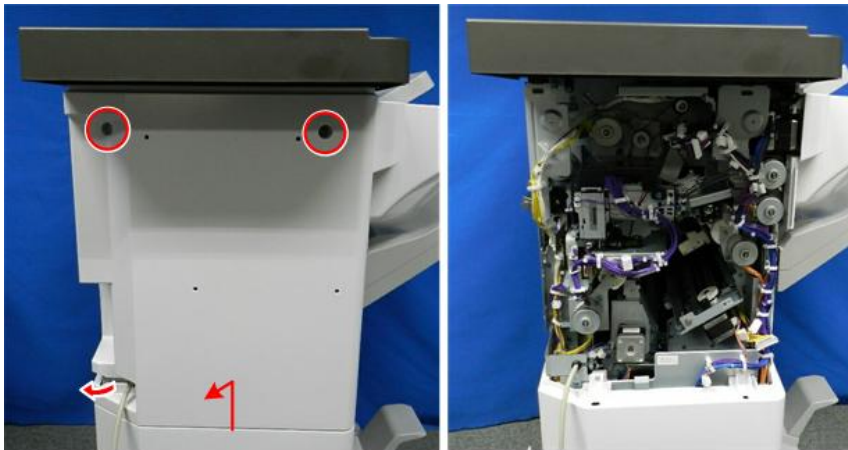

🔩 x2

d3cjc1002

3. Remove the shift tray.



 x1

d3cjc1003

4. Push the paper guides to the center.



d3cjc1004

5. Remove the rear paper guide cover.

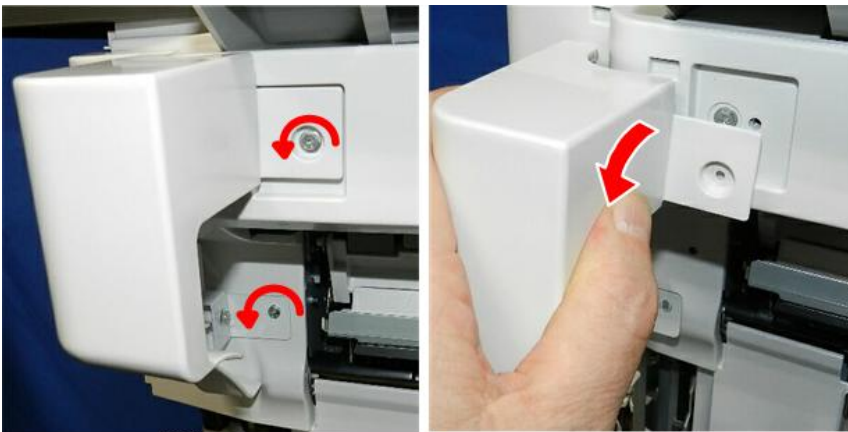

 x2

d3cjc1005

1.Replacement and Adjustment

6. Remove the front paper guide cover.



7. Disconnect the main paper guide cover.



8. Carefully, separate the front tabs at [A], and then remove the main paper guide cover [B].

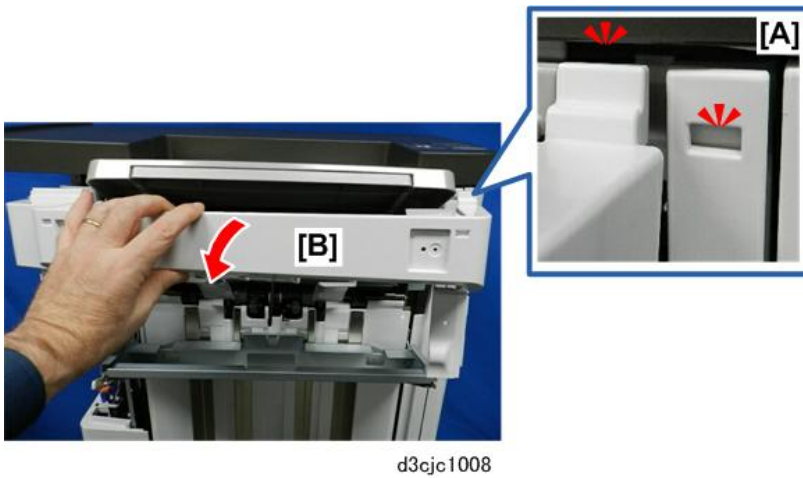

Lower Tray

1. Lower tray [A]



d1351262

Proof Tray

1. Remove the following covers. [Rear Upper Cover](#), [Rear Lower Cover](#), [Upper Cover](#)
 - Rear upper cover
 - Upper cover
2. Proof tray [A] (🔑 x 2)

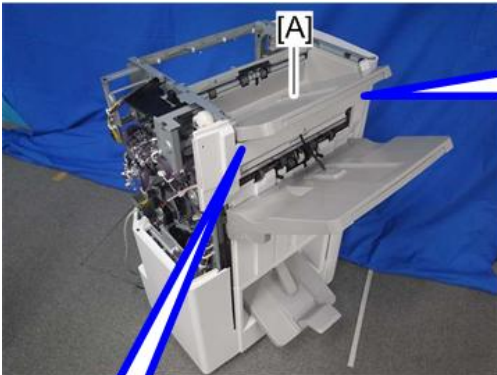

d1351263



1.Replacement and Adjustment

Upper Tray

1. Upper tray [A] (🔑 x 1)

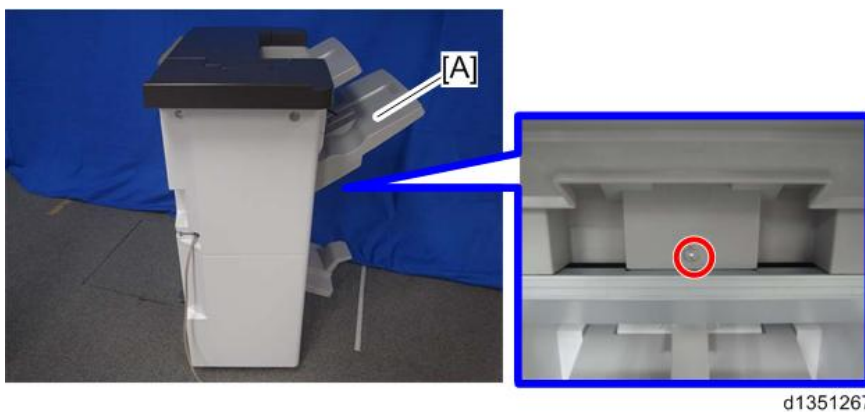

End Fence (SR4130)

1. Remove the rear upper cover. [Rear Upper Cover](#), [Rear Lower Cover](#), [Upper Cover](#)
2. Support the upper tray [A] with your right hand, and then pull gear [B] toward you to release.

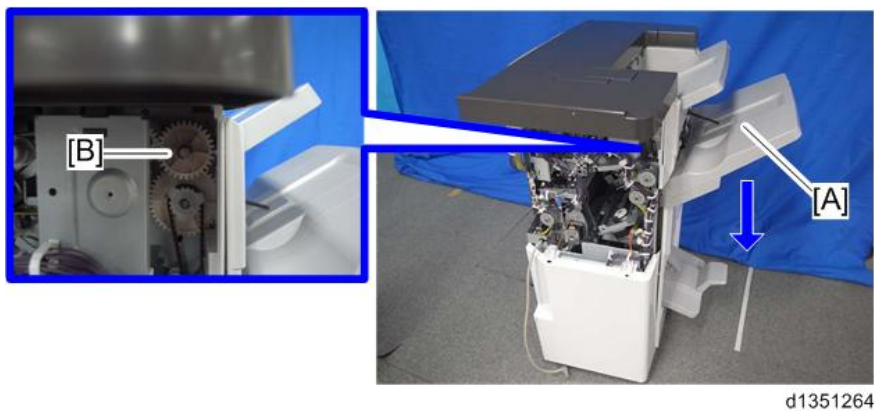

3. Upper tray [A] (🔑 x 1)

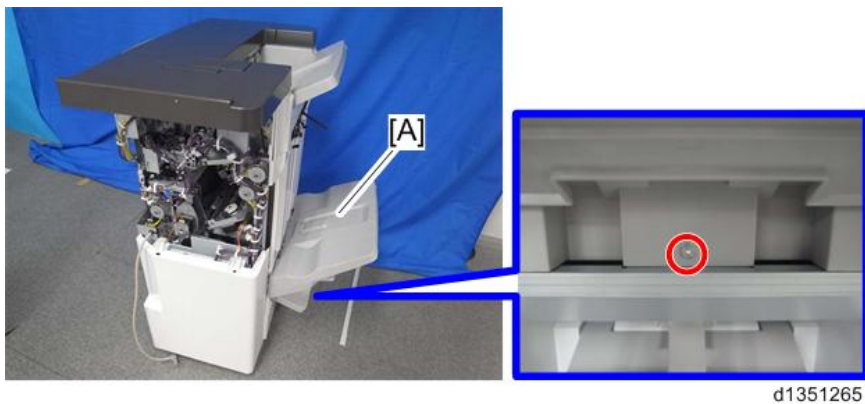

4. Lower Tray (Lower Tray)

5. End fence [A] (🔩 x 2)

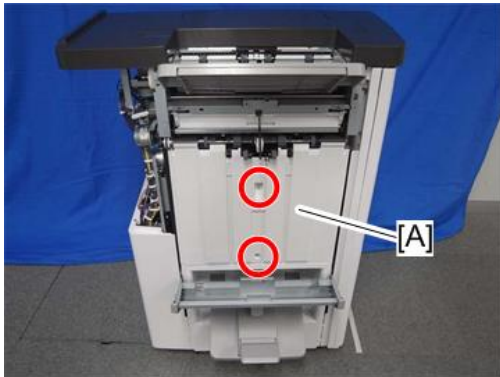

d1351266

End Fence (SR4120)

1. Upper Tray [A] (🔩 x 1)

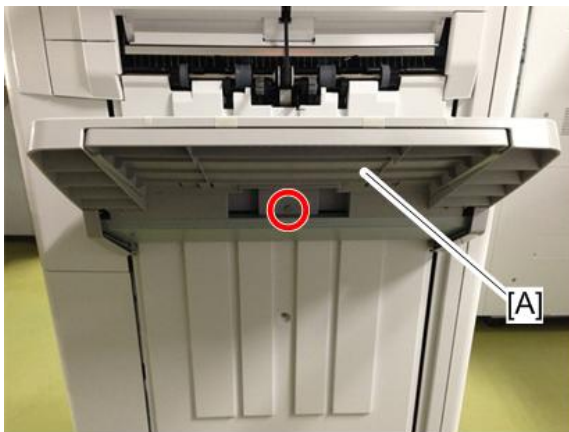

d1351777

2. Shift tray bracket [A] (🔩 x 4)

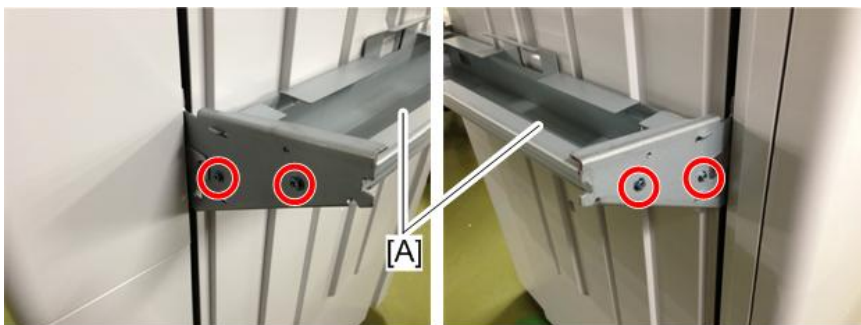

d1351780

1.Replacement and Adjustment

3. End fence [A] (🔩 x 3)

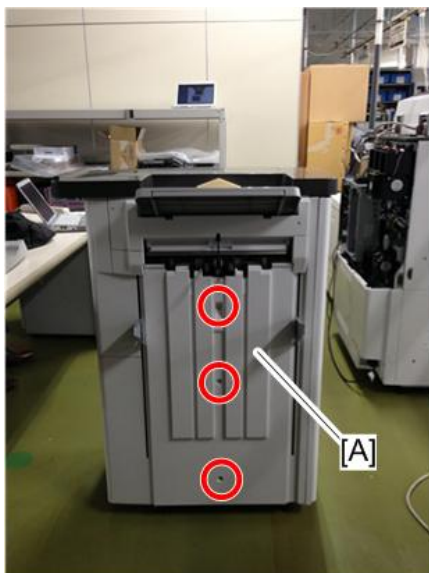

d1351781

Paper Guide Unit

1. Remove the paper exit guide.
2. If the Output Jogger Unit Type M25 (option) unit is installed, remove it.
3. Remove paper guide cover support bracket [A] (🔩 x2).

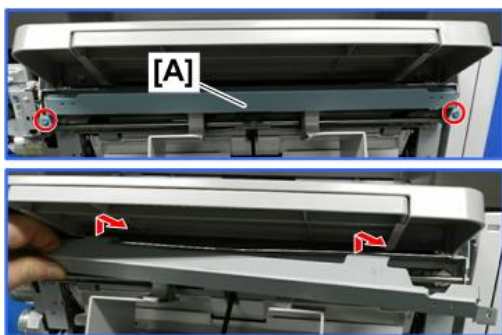

d3cjc1009a

4. At the front and back remove the shoulder screws [A] and [B] of the output jogger unit if it was installed.

Note

- Removing the jogger unit makes it easier to access the paper guide unit fastening screws. Do not lose these screws.

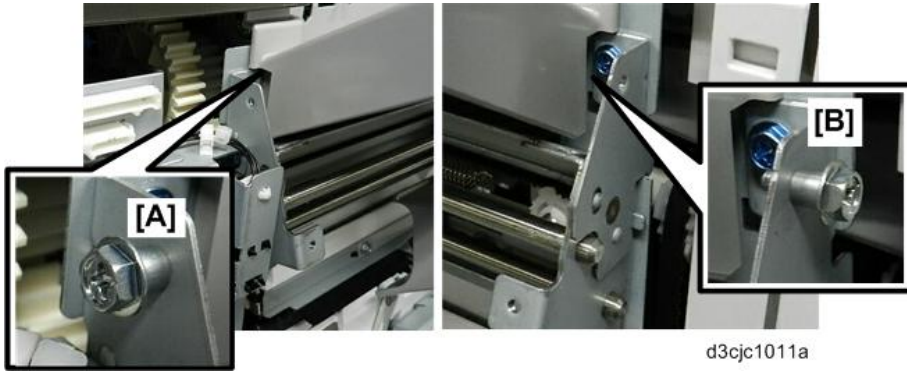

5. Loosen the proof tray screws temporarily to make it easier to reach the paper guide fastening screws.

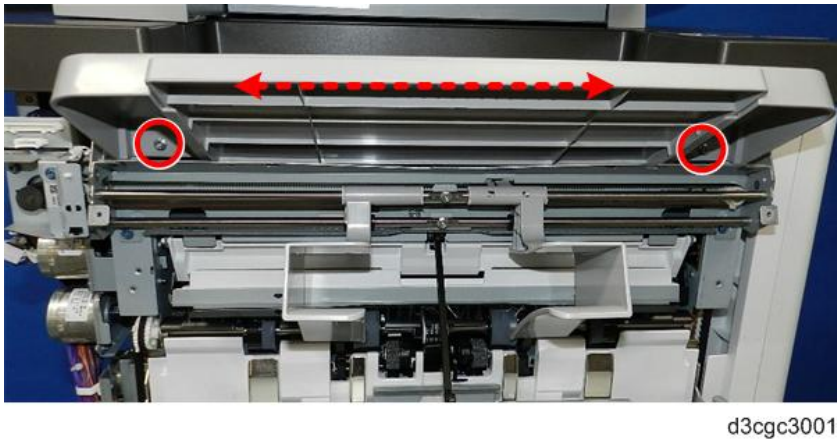

6. Remove the paper guide fastening screws at the front [A] and rear [B] (⌀ x4).

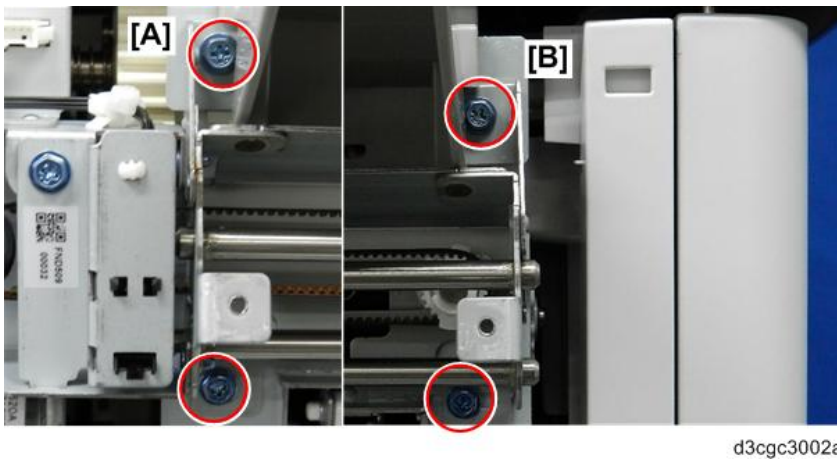

1.Replacement and Adjustment

7. At the rear, open the clamp, and then disconnect the motor and sensor (🔌x2, 📡x2).

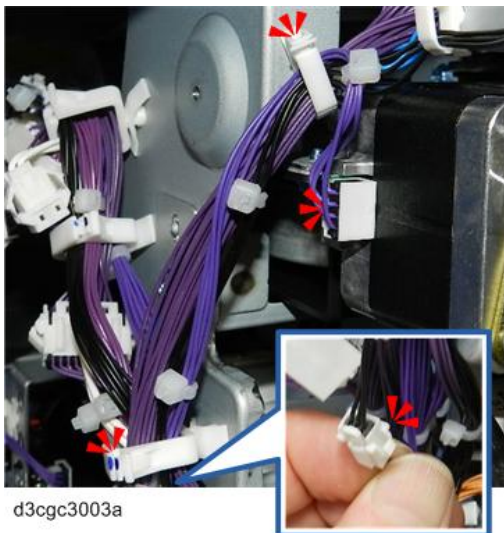

8. Tilt the paper guide unit toward you, and then disconnect the harness of motor bracket [A].

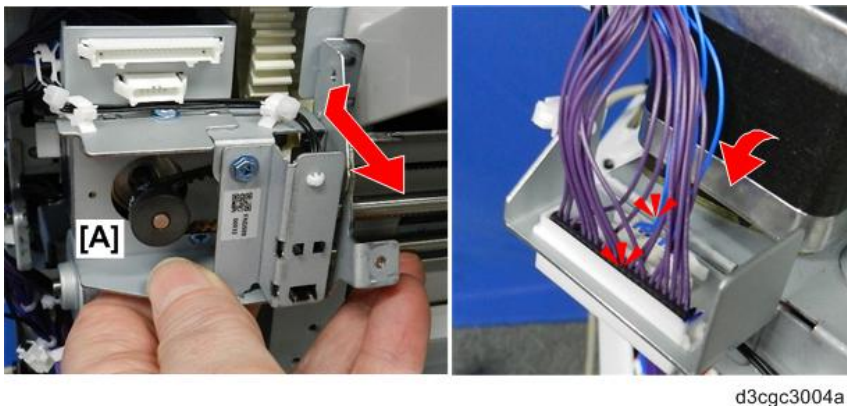

9. Remove the paper guide unit and place on a flat, clean surface.

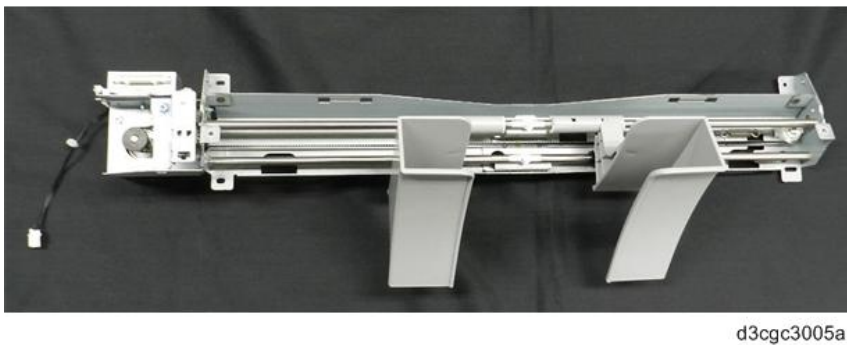

Boards

Main Board

1. Remove the following covers. [Rear Upper Cover](#), [Rear Lower Cover](#), [Upper Cover](#)
 - Rear upper cover
 - Rear lower cover
2. Main board [A] (🔧 x 4, 📦 x All)

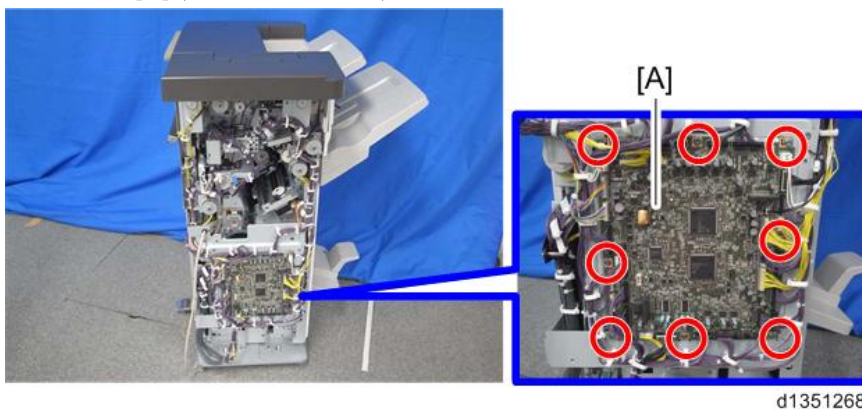

When replacing the main board

This board has two blocks of DIP switches. When you reinstall the main board, follow the procedure below regarding the dip switch settings.

1. Check the settings of dip switch [A] on the old main board.
2. Replace the main board.
3. Change the settings of dip switch [A] on the new main board to match the settings on the old main board.
4. Make sure the switches of dip switch [B] on the new main board are all OFF.

1.Replacement and Adjustment

5. When replacing the control board, remove EEPROM [C] from the old board and install it on the new board.

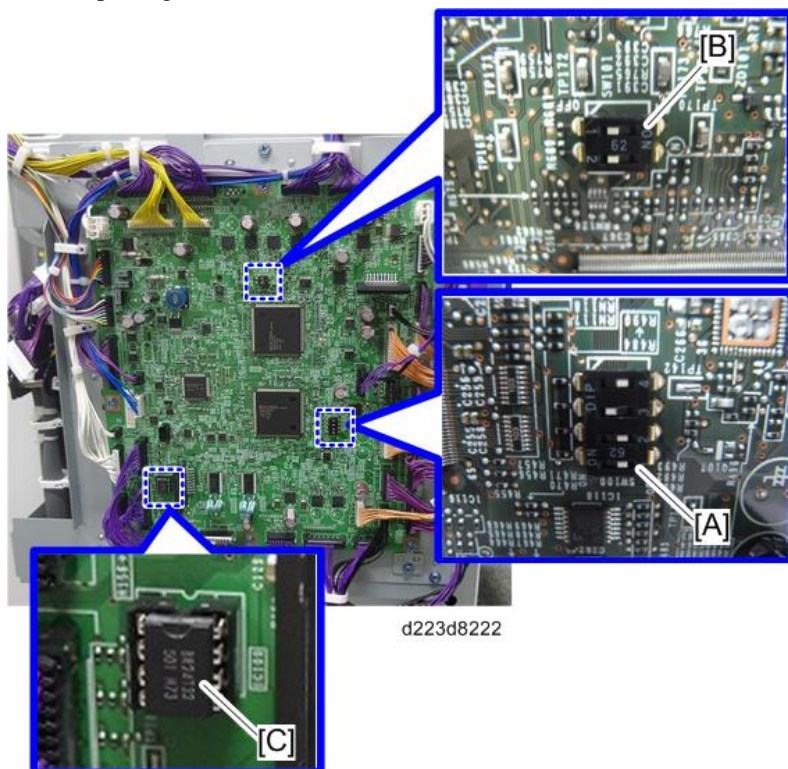

6. Locate the seal [A] attached near the right corner of the board.

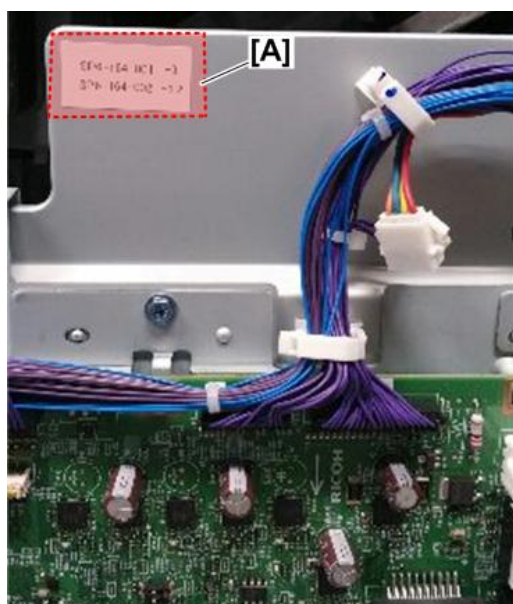

7. Go into the SP mode, open these SP codes, and then enter the numbers you see on the seal.
 - SP6121-001 NV Adj. Data: Jog Position: Factory Adj.
 - SP6121-002 NV Adj. Data: Fold Position: Factory Adj.

Main Motors

Corner Stapling Unit

1. Remove the following covers. [Covers](#)
 - Front door
 - Front left side cover
 - End fence
 - Rear upper cover
 - Rear lower cover
2. Pull out the booklet stapler unit, and remove the inner upper cover [A]. (⊗ x 2)

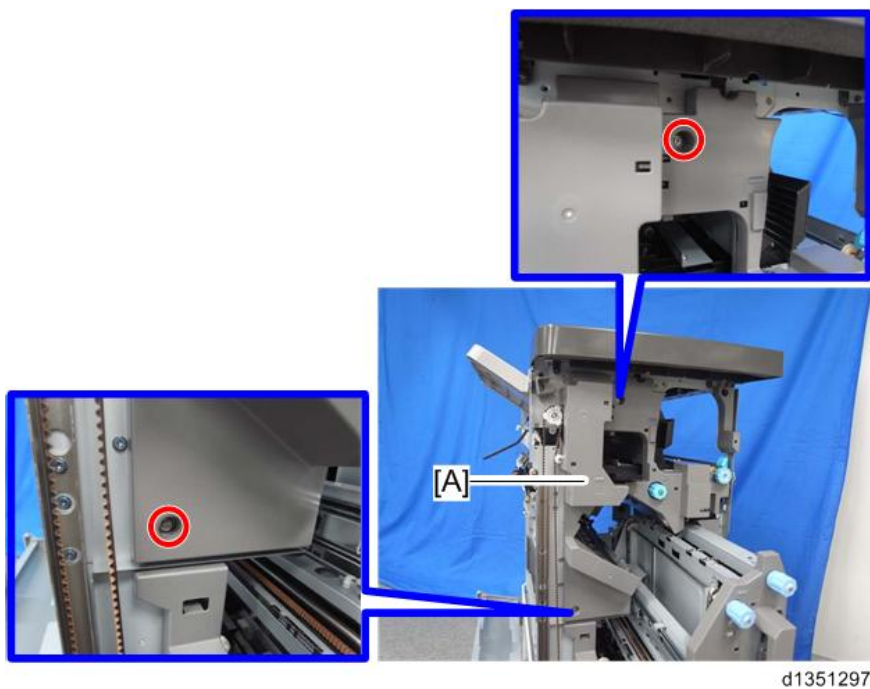

Note

- Disconnect the harness from the back side of the inner upper cover when you remove the inner upper cover.

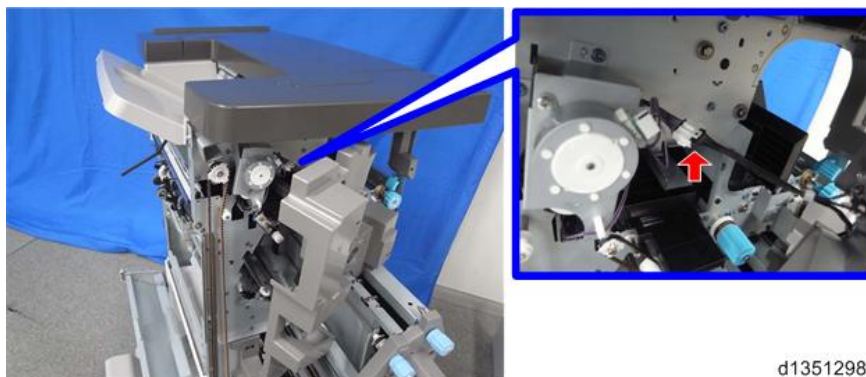

1.Replacement and Adjustment

3. Remove the screws from the front side of the finisher. (🔩 x 6)

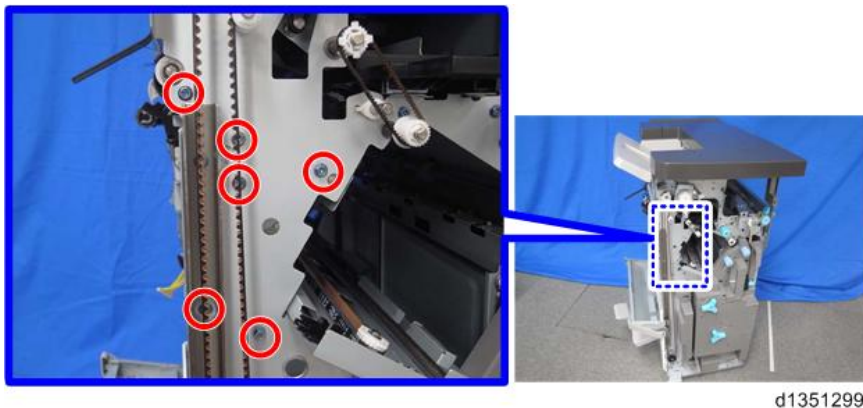

4. Remove the bushing [A] from the front side of the finisher. (🔩x1)

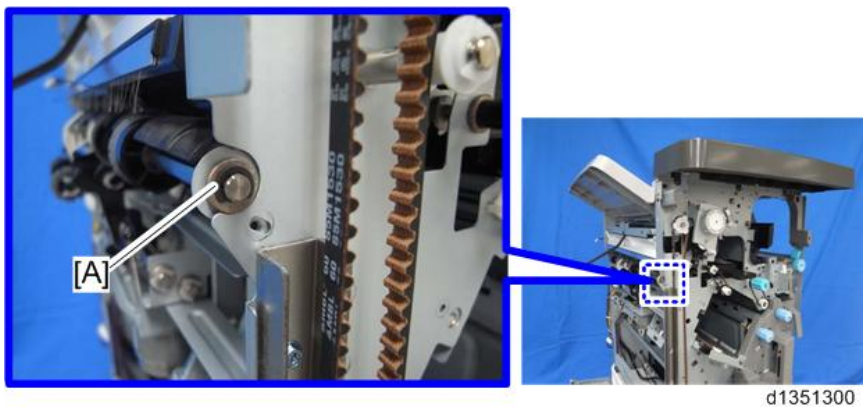

5. Remove the pressure release motor bracket [A] from the rear side of the finisher. (🔩 x 2)

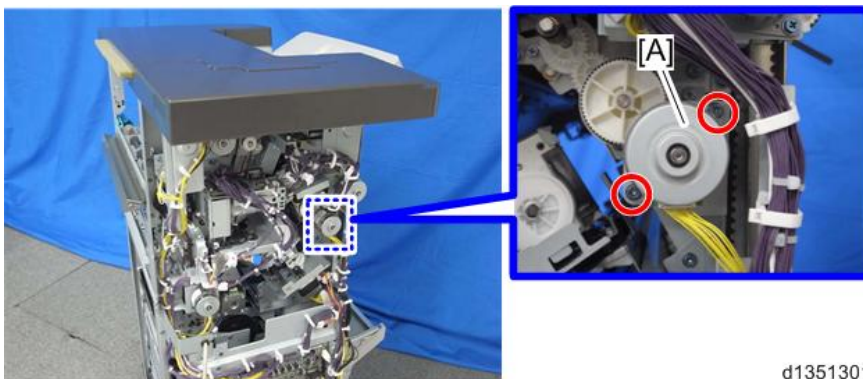

6. Remove the gear [A] from the rear side of the finisher. (⌚x 1)

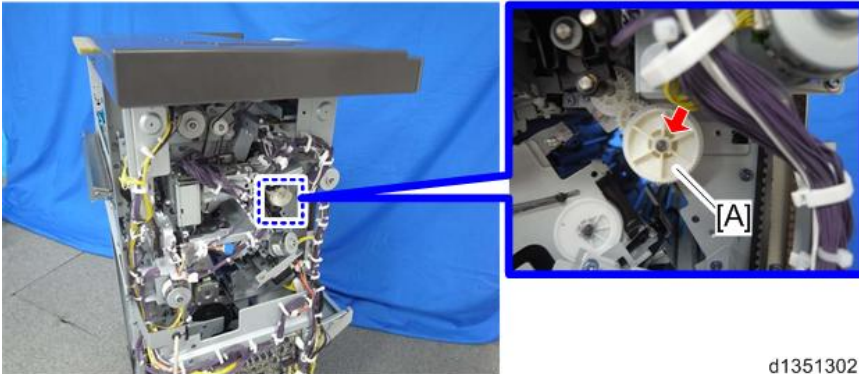

d1351302

7. Remove the pulley [A] from the rear side of the finisher. (⌚x 1)

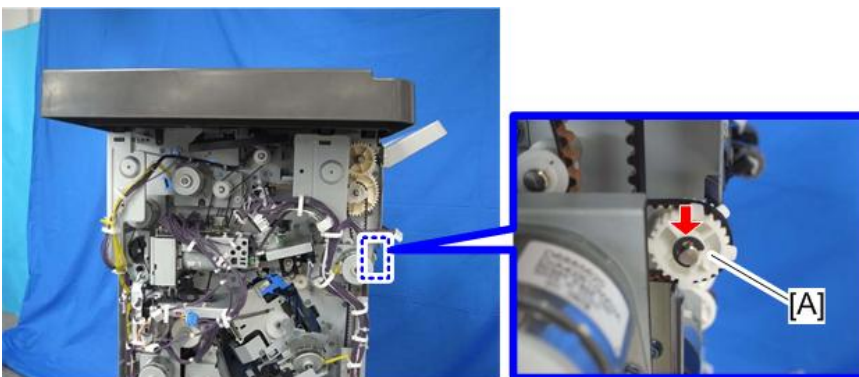

d1351303

1.Replacement and Adjustment

8. Remove screws from the rear side of the finisher. (🔩 x 6)

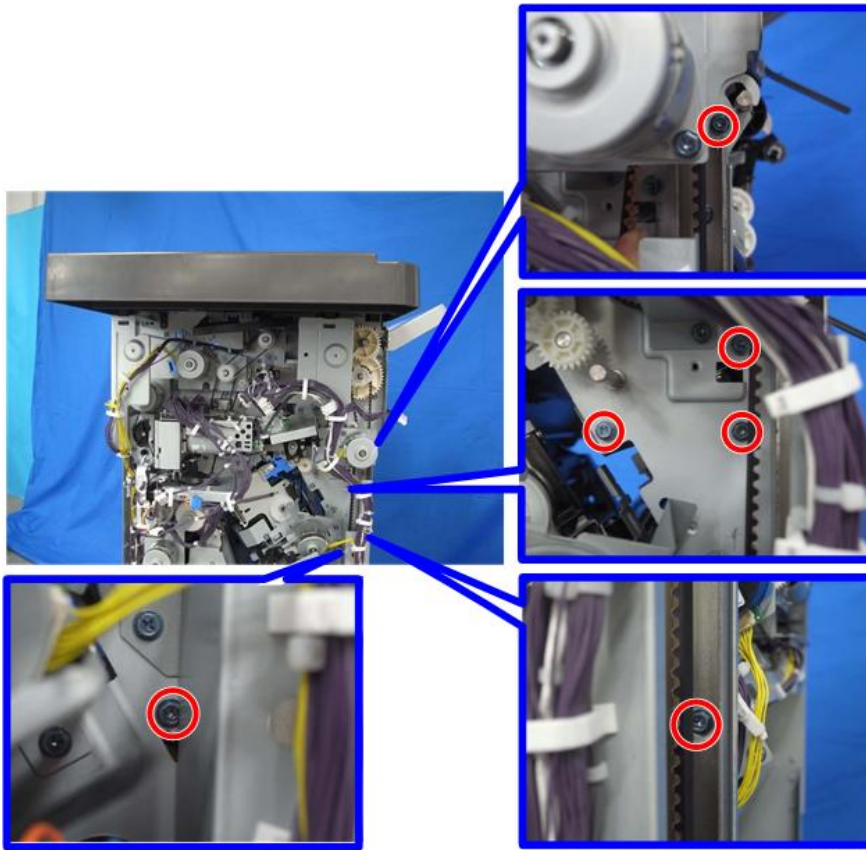

d1351304

9. Remove the clamps shown below. (🔗 x 6)

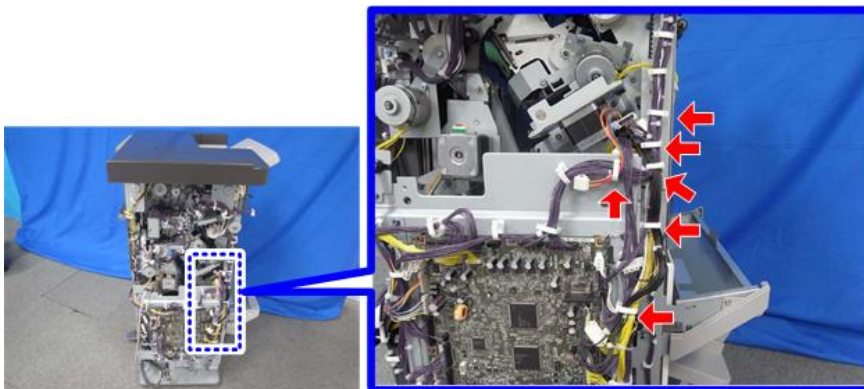

d1351305

10. Disconnect the ground wire [A] of the main board. (🔧 x 1)

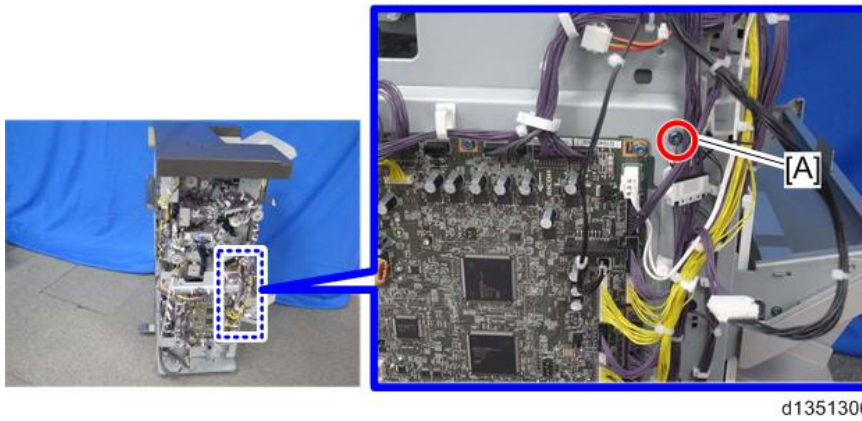

11. Disconnect the connectors shown below. (🔧 x 8)

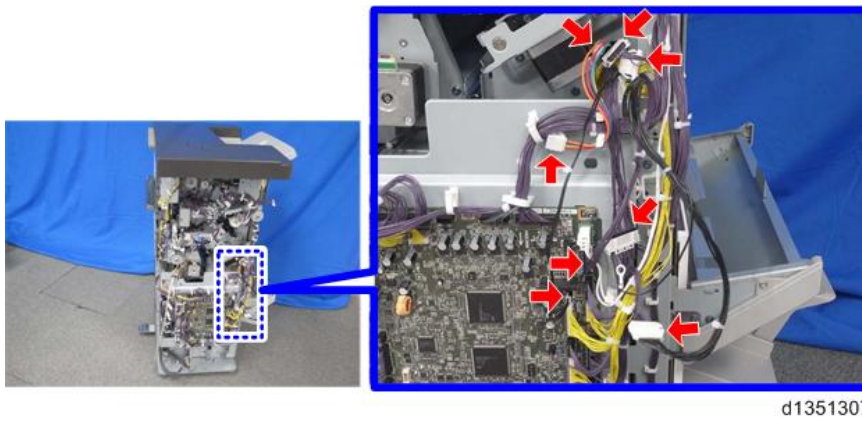

12. Pull out the harnesses disconnected in step 11 to the right side of the finisher through the hole [A].

13. Remove the harness from the clamps. (🔧 x 4)

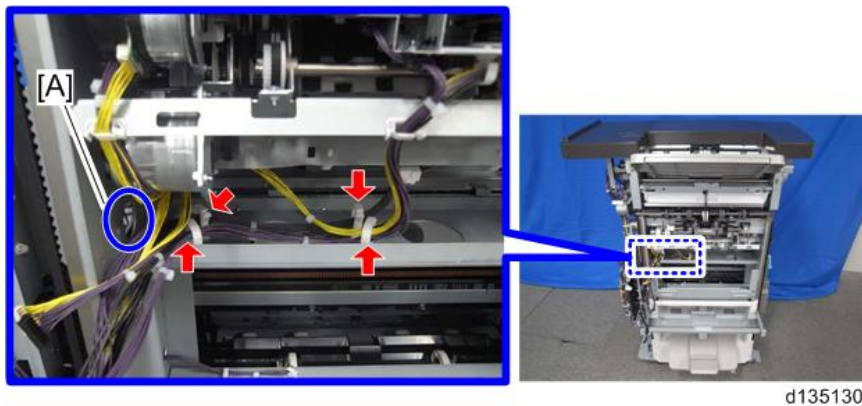

1.Replacement and Adjustment

14. Remove the corner stapling unit [A] from between the front and left plates.

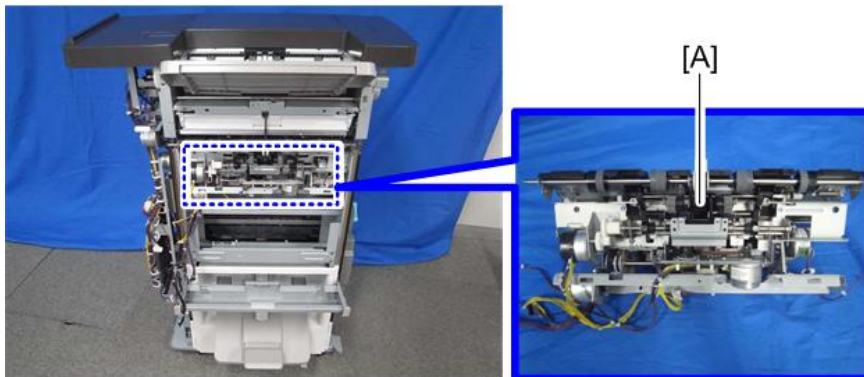

d1351309

Paper Exit Gate Motor

1. Corner stapling unit (Corner Stapling Unit)
2. Stapler bracket [A] (🔩 x 3, 🛠️ x 1)

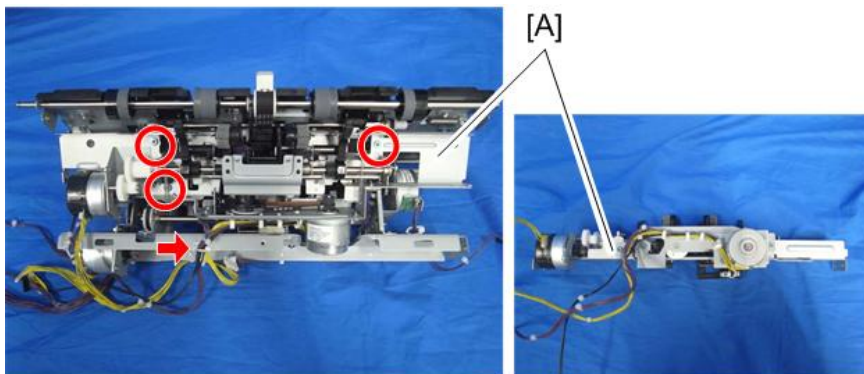

d1351269

3. Paper exit gate motor [A] (🔩 x 2, 🛠️ x 1)

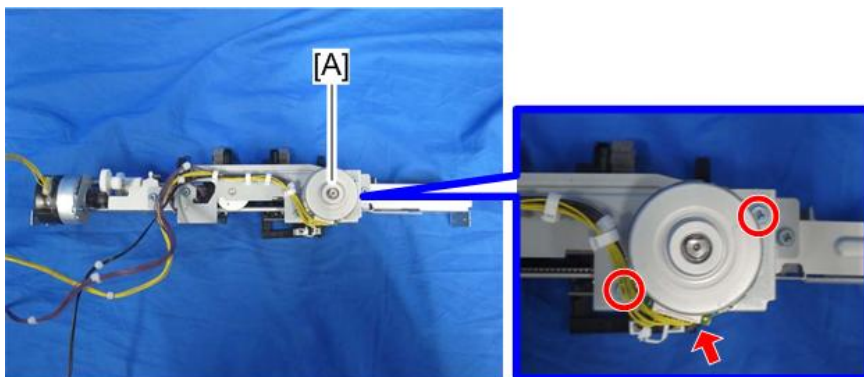

d1351270

Leading Edge Guide Motor

1. Corner stapling unit (Corner Stapling Unit)

2. Stapler bracket [A] (🔩 x 3, 📦 x 1)

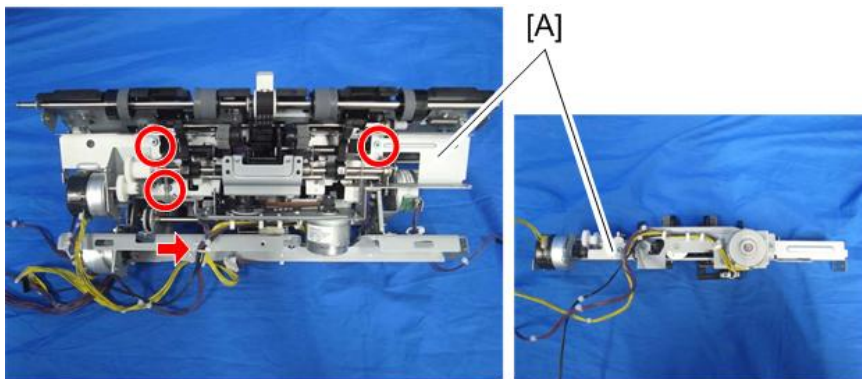

d1351269

3. Leading edge guide motor [A] (🔩 x 2, 📦 x 1)

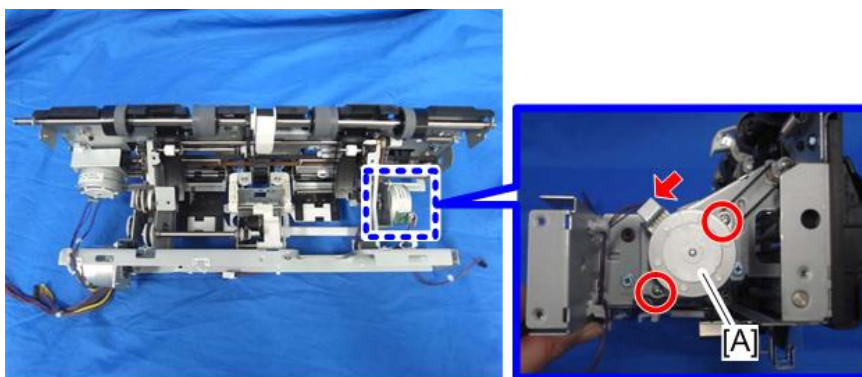

d1351271

Trailing Edge Pressure Plate Motor

1. Corner stapling unit (Corner Stapling Unit)
2. Trailing edge pressure plate motor [A] (🔩 x 2, 📦 x 1)

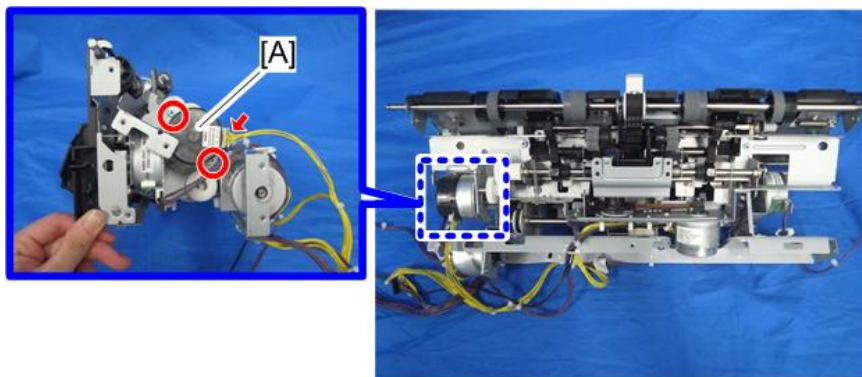

d1351272

Stacking Roller Motor

1. Rear upper cover (Covers)

1.Replacement and Adjustment

- Stacking roller motor [A] (🔩 x 2, 📦 x 1)

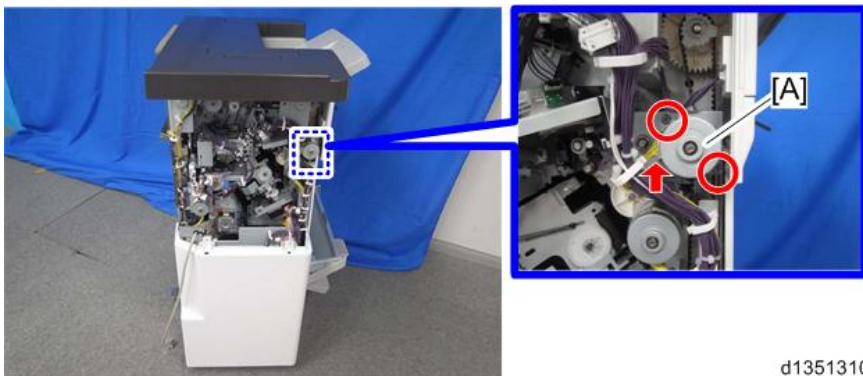

d1351310

Feed Out Motor

- Corner stapling unit (Corner Stapling Unit)
- Feed out motor [A] (🔩 x 2, 📦 x 1, 📦 x 2)

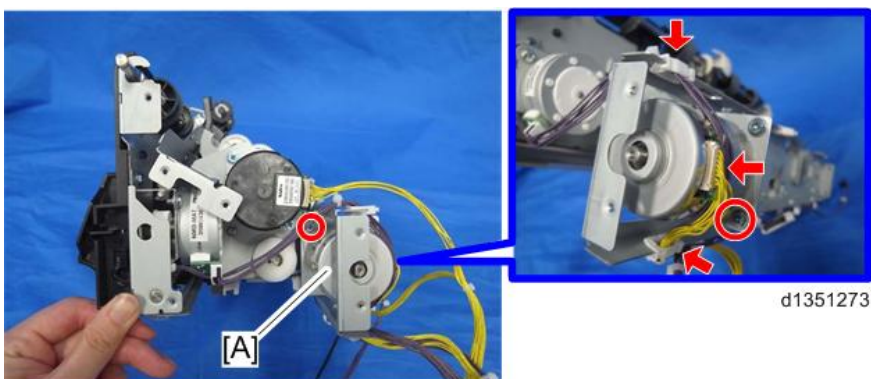

d1351273

Jogger Motor

- Corner stapling unit (Corner Stapling Unit)
- Stapler bracket [A] (🔩 x 3, 📦 x 1)

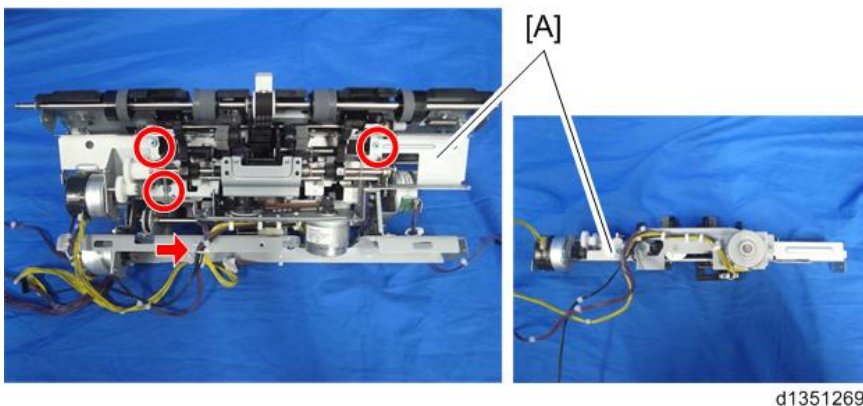

d1351269

- Feed out motor (Feed Out Motor)

4. Jogger motor [A] (⚙️ x 2, 📦 x 1)

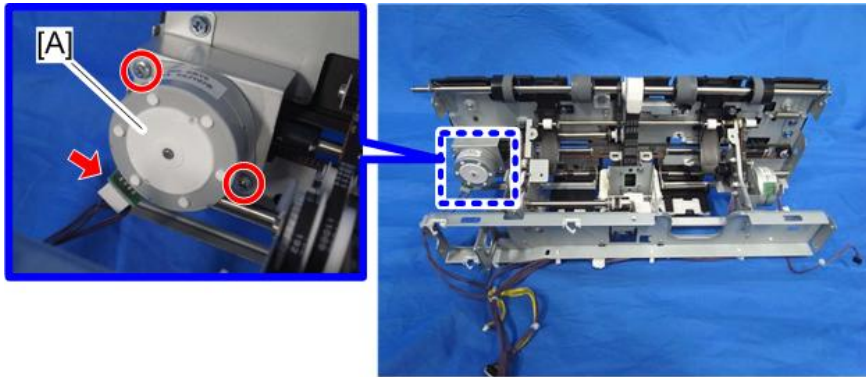

d1351274

Paper Guide Motor

1. The paper guide motor is at [A].

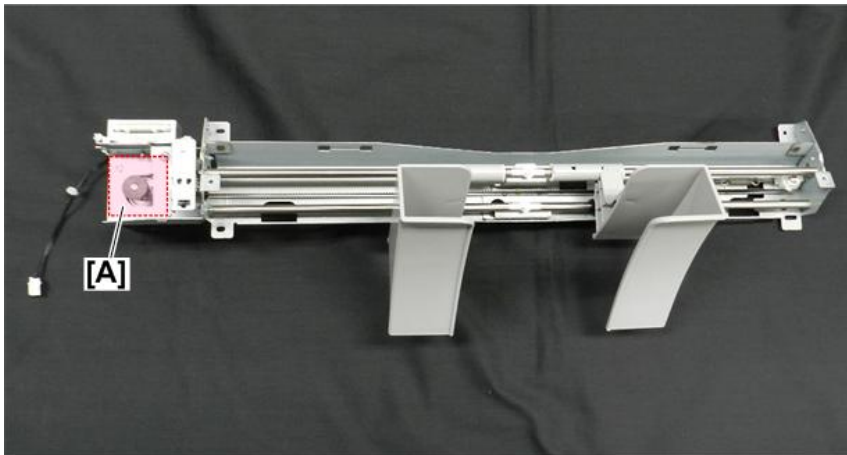

d3cgc3005c

2. Remove the paper guide unit. [Paper Guide Unit](#)
3. Remove sensor bracket (≠x1).

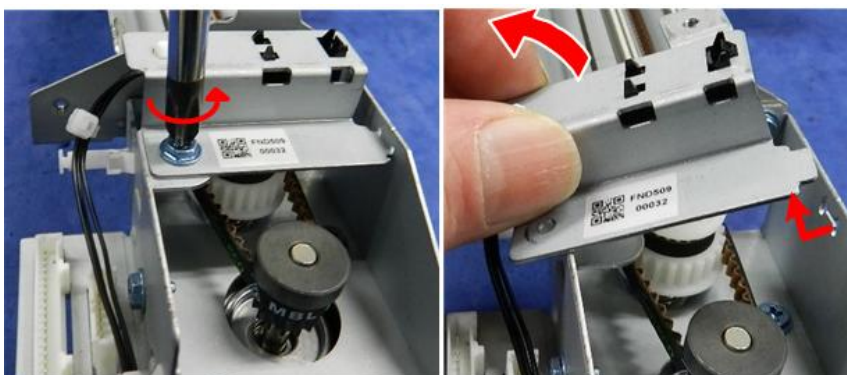

d3cgc3006a

1.Replacement and Adjustment

4. Unfasten the motor, and disconnect the belt (✂x2, 🌀x1).

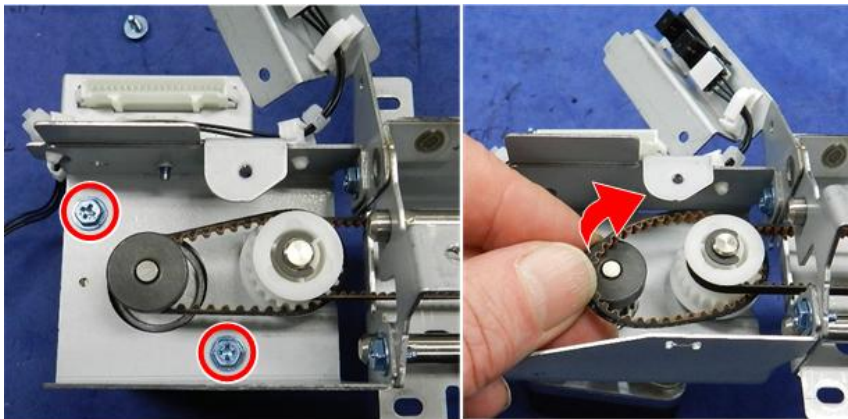

d3cgc3010a

5. Disconnect the motor harness, and then remove the motor (🔪 x1).

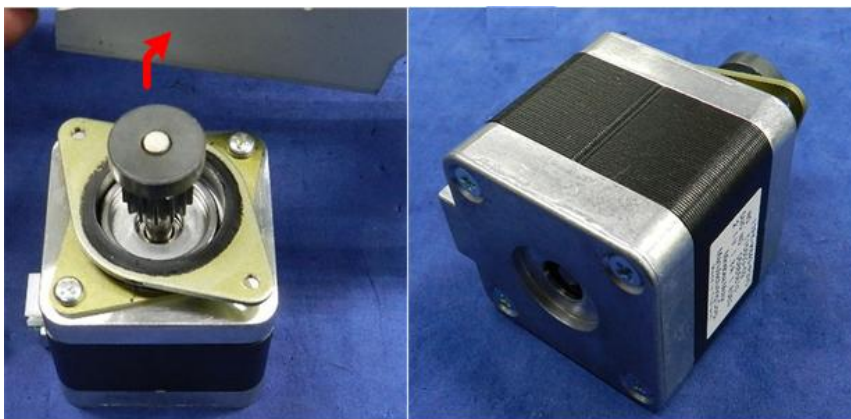

d3cgc3011

6. When you re-install the motor, make sure that the connector is pointing to the back of the unit.



d3cgc3012

Sensors

Shift Tray Paper Sensor

1. Corner stapling unit
2. Stapler bracket [A] (🔩 x 3, 🛠️ x 1)

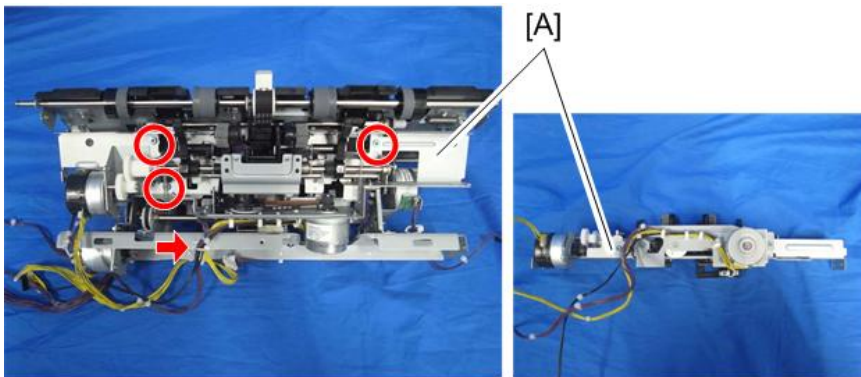

d1351269

3. Shift tray paper sensor bracket [A] (🔩 x 1)

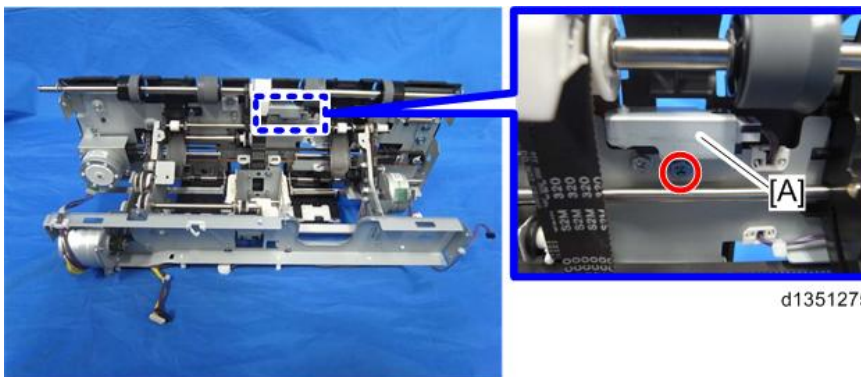

d1351275

4. Shift tray paper sensor [A] (🔩 x 1, 📦 x 1)

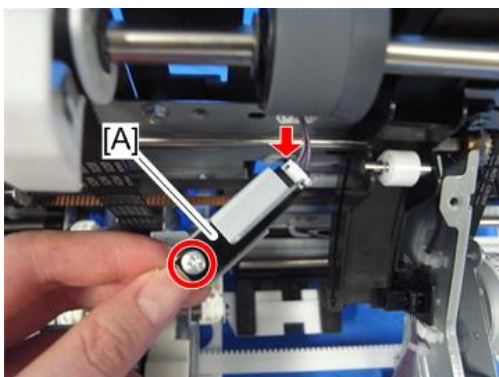

d1351276

Trailing Edge Pressure Plate HP Sensor

1. Corner stapling unit (Corner Stapling Unit)

1.Replacement and Adjustment

2. Stapler bracket [A] (🔩 x 3, 🛠️ x 1)

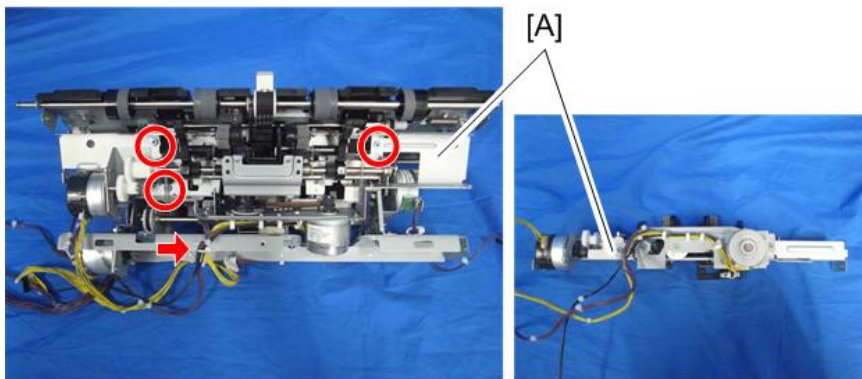

d1351269

3. Turn back the stapler bracket, and remove the trailing edge pressure plate HP sensor bracket [A]. (🔩 x 1)

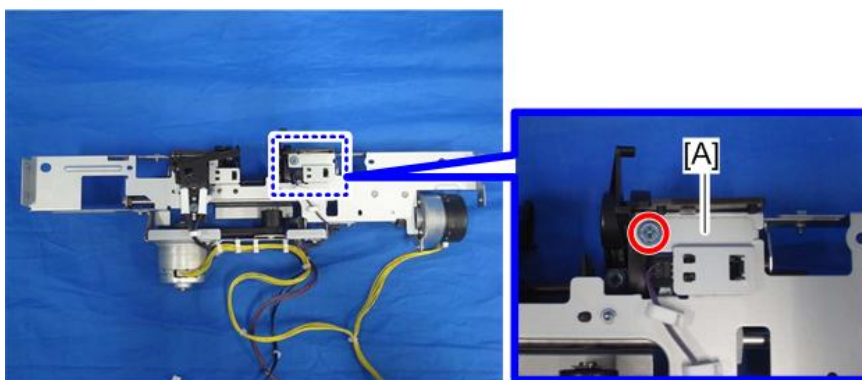

d1351290

4. Trailing edge pressure plate HP sensor [A] (🛠️ x 1)

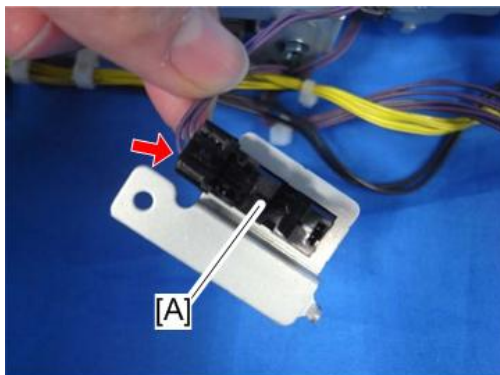

d1351291

Stacking Roller HP Sensor

1. Corner stapling unit (Corner Stapling Unit)

2. Stapler bracket [A] (🔩 x 3, 🛠️ x 1)

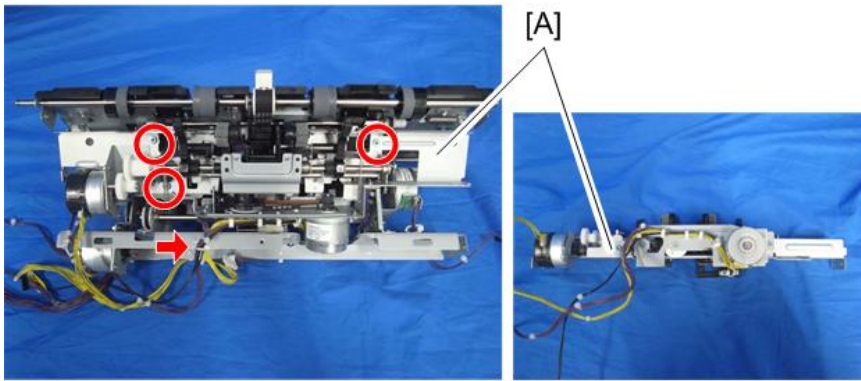

d1351269

3. Turn back the stapler bracket, and remove the paper exit gate motor bracket [A]. (🔩 x 1, 🛠️ x 1)

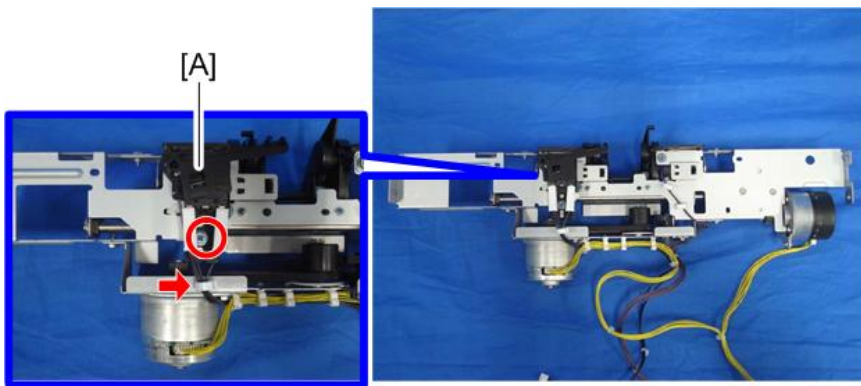

d1351292

4. Stacking roller HP sensor bracket [A] (🔩 x 1)

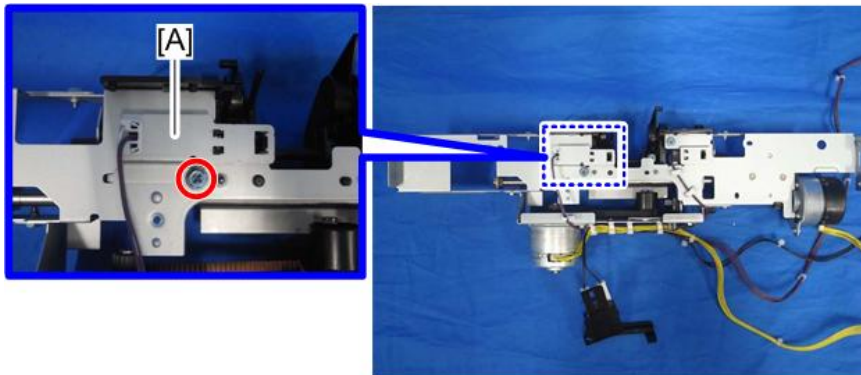

d1351293

1.Replacement and Adjustment

5. Stacking roller HP sensor [A] (🔧 x 1)

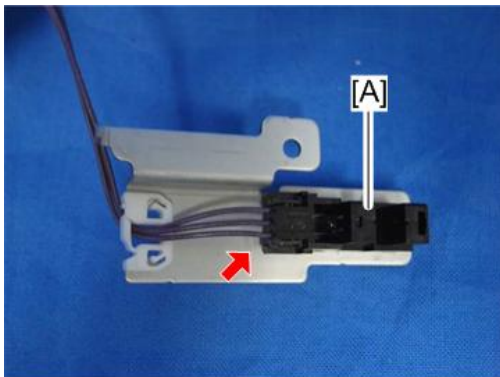

d1351294

Staple Tray Paper Sensor

1. Corner stapling unit (Corner Stapling Unit)
2. Stapler bracket [A] (🔧 x 3, 🛠️ x 1)

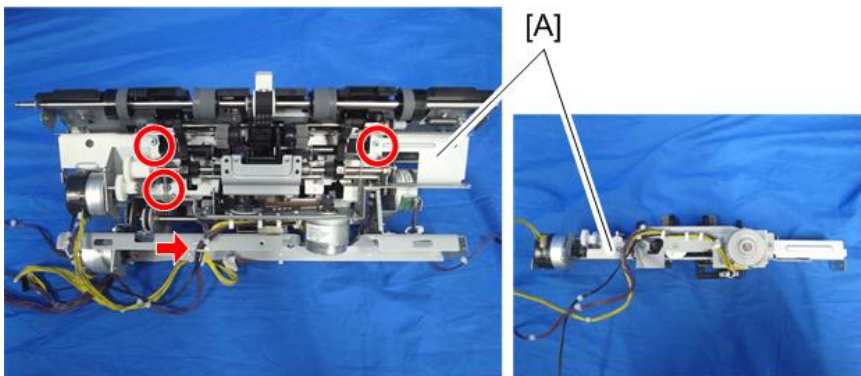

d1351269

3. Staple tray paper sensor bracket [A] (🔧 x 1, 🛠️ x 1)

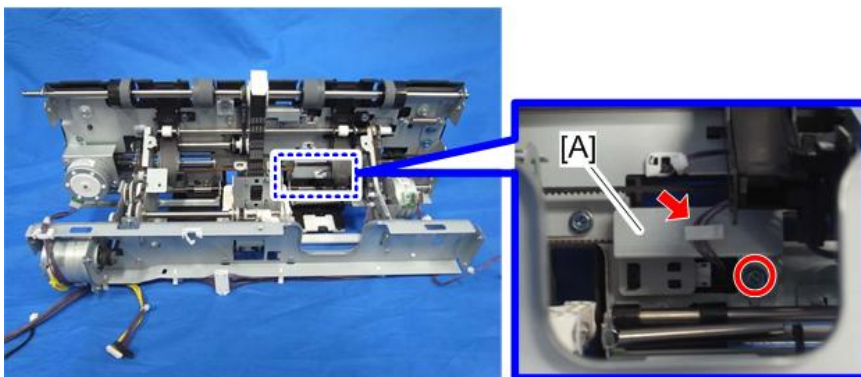

d1351295

4. Staple tray paper sensor [A] ( x 1)

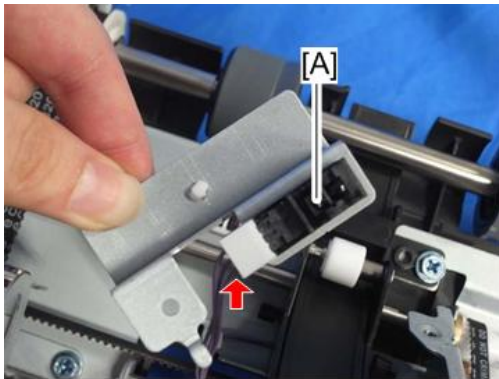

d1351296

Paper Guide HP Sensor

1. The paper guide HP sensor is located at [A].



d3cgc3005b

2. Remove the paper guide unit. [Paper Guide Unit](#)
3. Remove sensor bracket (*x1).

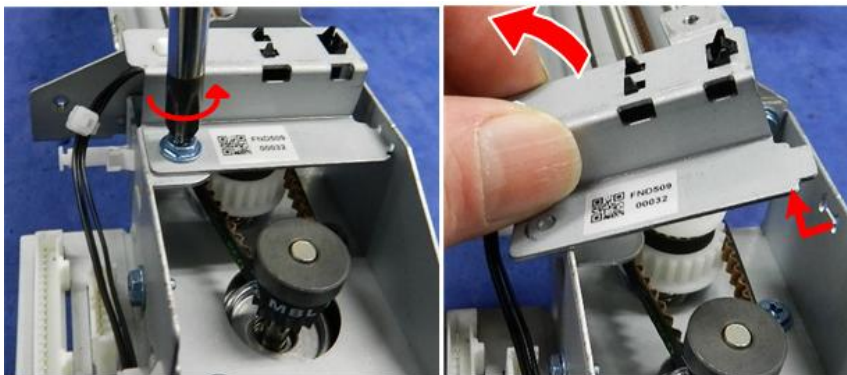

d3cgc3006a

1.Replacement and Adjustment

4. Open the clamp and disconnect the sensor (🔧x1, 📦 x1).



d3cgc3007a

5. Separate the sensor and bracket (▼x3).

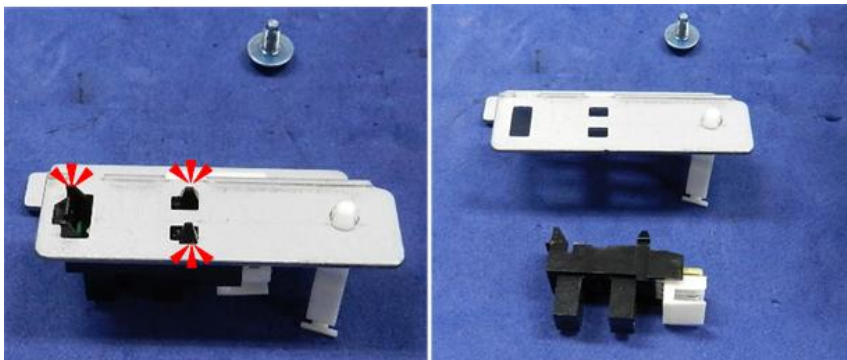

d3cgc3008a

Booklet Unit Motors

Booklet Stapler Unit

1. Remove the following covers. [Rear Upper Cover](#), [Rear Lower Cover](#), [Upper Cover](#)
 - Rear Upper Cover
 - Rear Lower Cover
2. Remove the ground wire [A] in the left lower side of the main unit. (🔧 x 1)

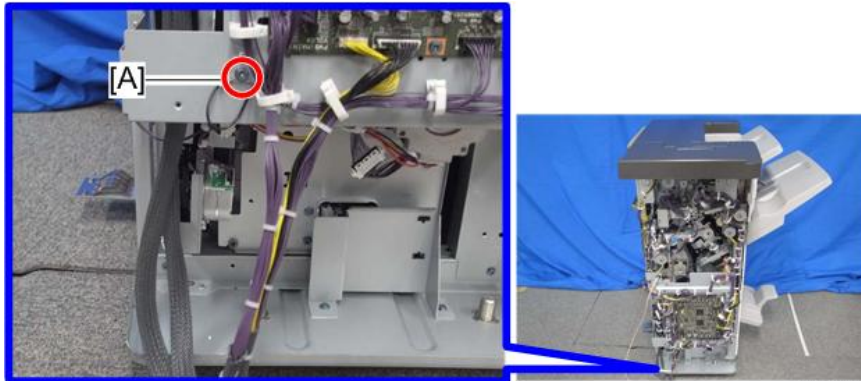

d1351316

3. Release the harness from the 4 clamps shown below. (🔧 x 4)

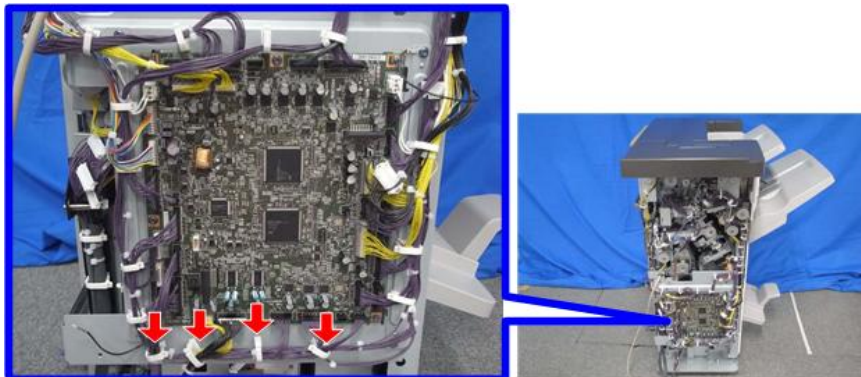

d1351317

4. Disconnect the following 7 connectors from the main board. (🔧 x 7)

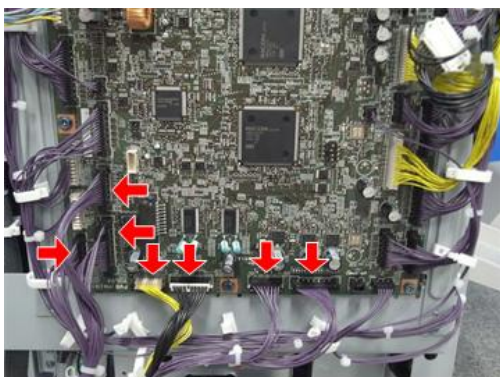

d1351318

1.Replacement and Adjustment

5. Open the front door [A] and pull out the booklet stapler unit [B].

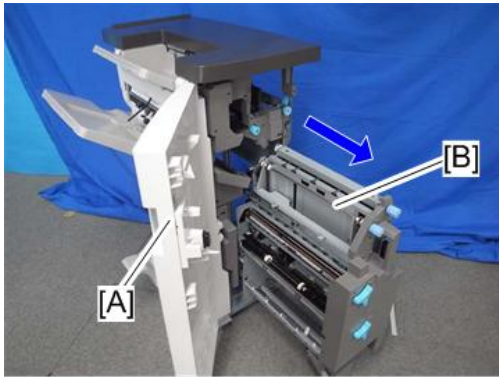

d1351319

6. Remove the following screws. (⌀ x 6)

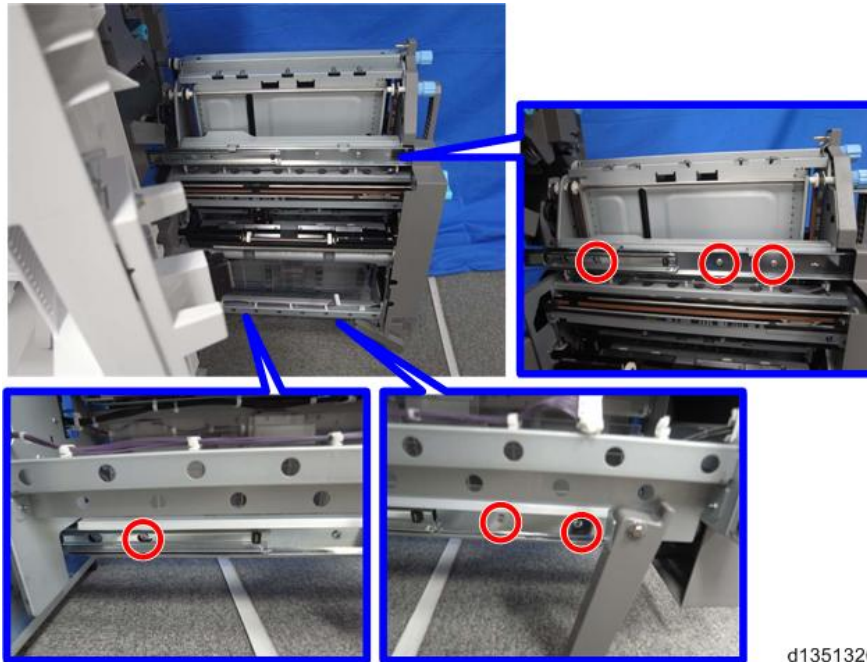

d1351320

7. Lift up to remove the booklet stapler unit [A]. (⊙ x 2)

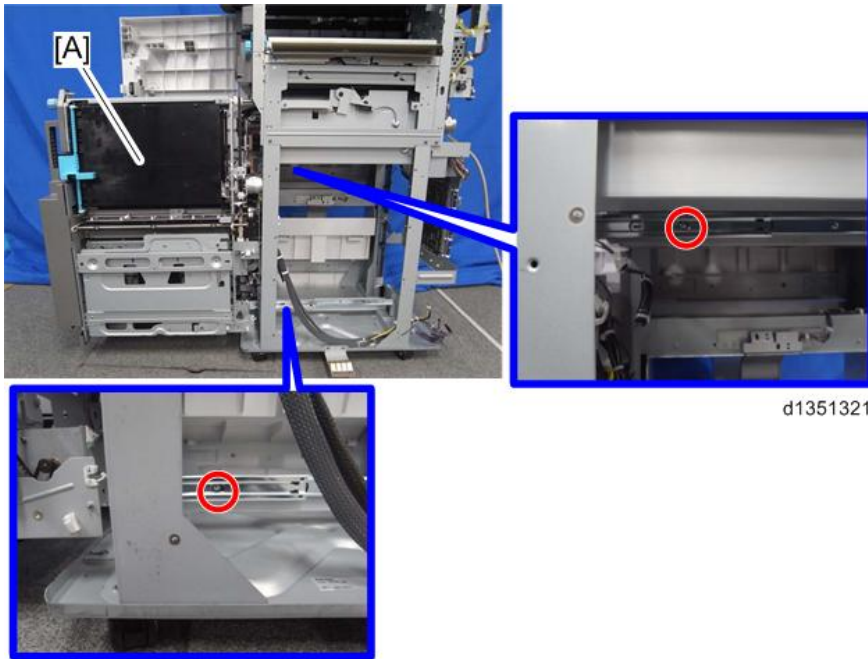

d1351321

Press Fold Motor

1. Booklet stapler unit [Booklet Stapler Unit](#)
2. Remove bracket [A]. (⊙ x 1)

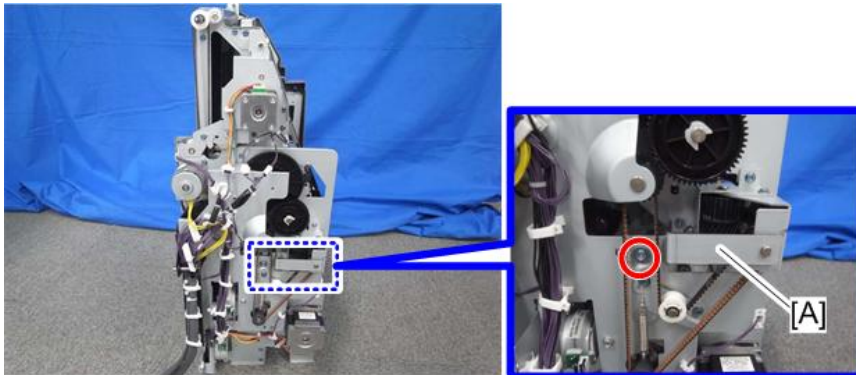

d1351322

3. Remove the screw [A]. (⊙ x 1)

1.Replacement and Adjustment

- 4. Loosen the screw [B] to loosen the press fold motor belt [C].

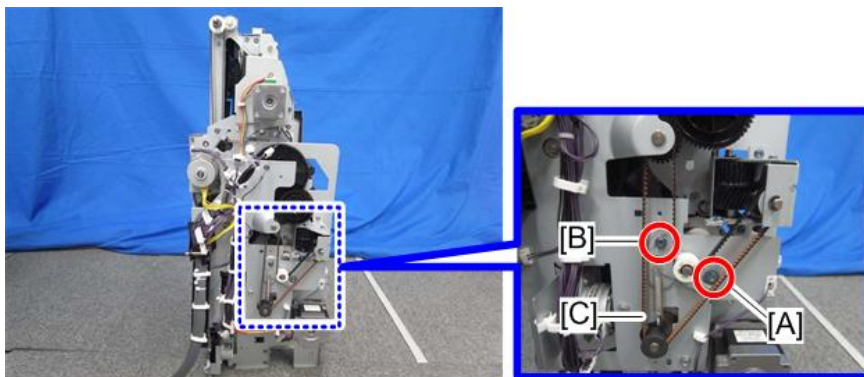

d1351323

- 5. Release the harness from the 6 clamps shown below. (🔧 x 6)

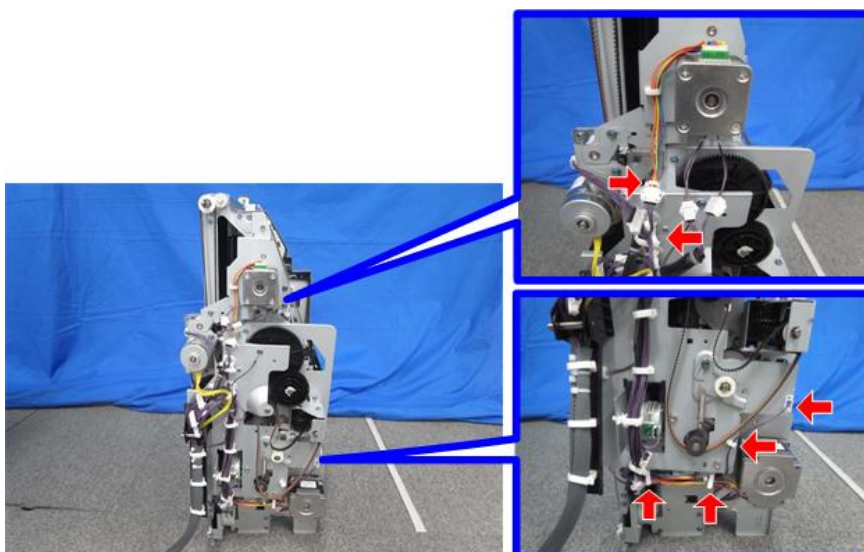

d1351324

- 6. Disconnect the 9 connectors shown below. (🔌 x 9)

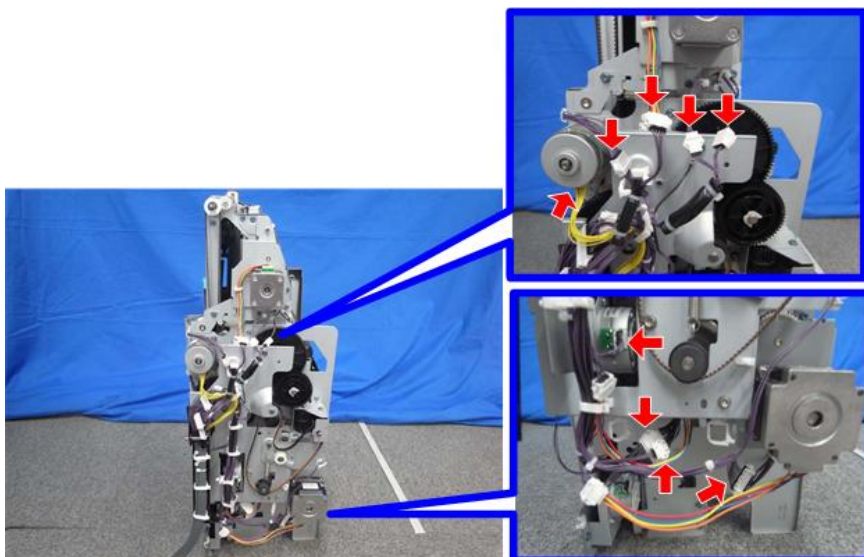

d1351325

7. Disconnect the 2 connectors shown below. (🔌 x 2)



8. Remove the press fold motor bracket [A]. (🔩 x 5)

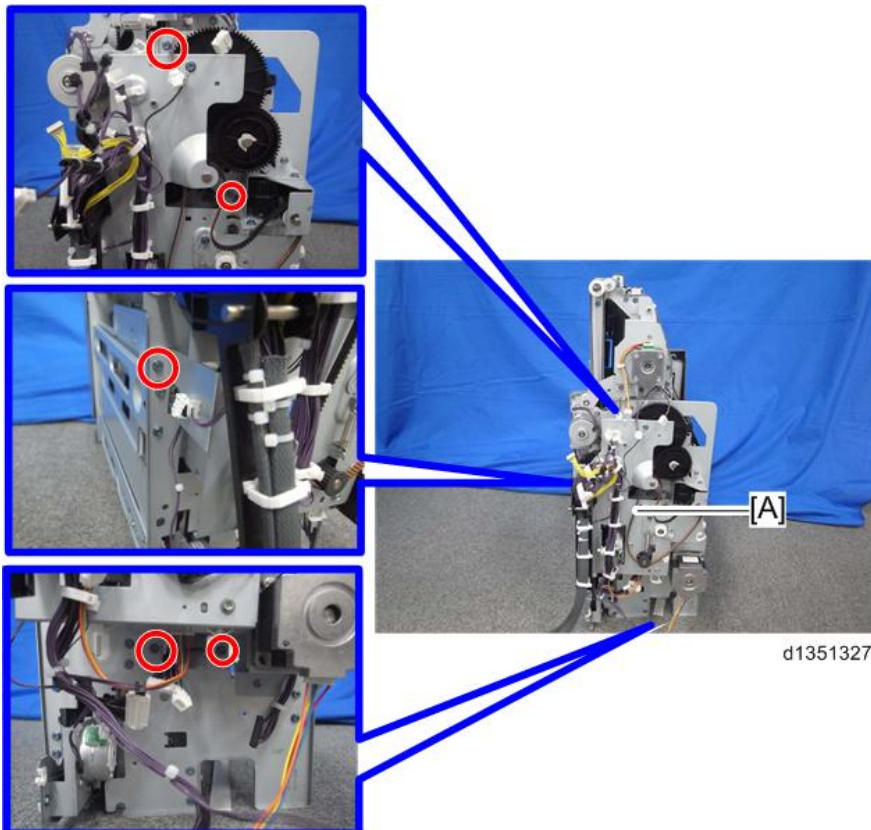

1.Replacement and Adjustment

9. Remove the spring [B] from the press fold motor bracket [A] (🔩 x 1, 🌀 x 1)

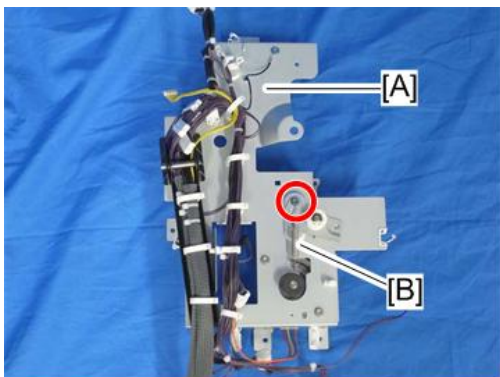

d1351328

10. Remove the press fold motor [A] (🔩 x 2, 🗝️ x 1)

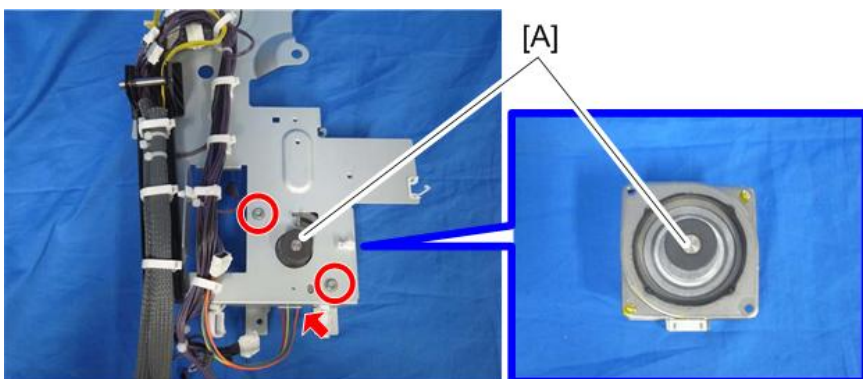

d1351329

Booklet Jogger Motor

1. Booklet stapler unit [Booklet Stapler Unit](#)
2. Press fold motor bracket [Press Fold Motor](#)
3. Booklet Jogger Motor [A] (🔩 x 2)

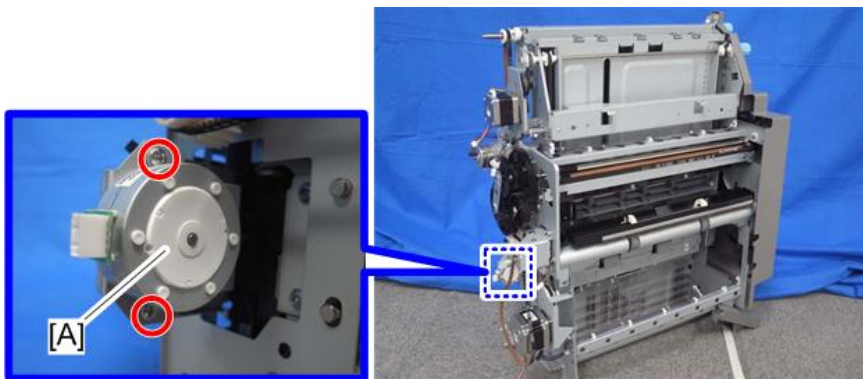

d1351330

Stapler Unit

Stapler Unit

1. Remove the rear upper cover [A]. (⊖ x 2)

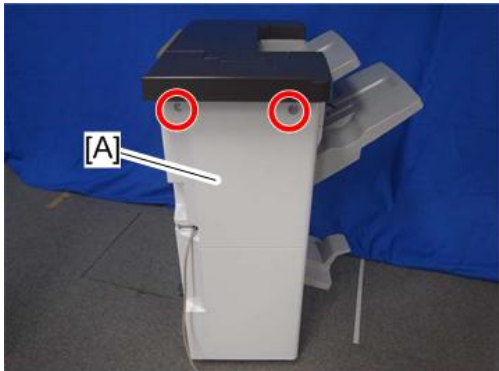

d1351253

2. Open the front door and push the stapler [A] to the rear side of the finisher.

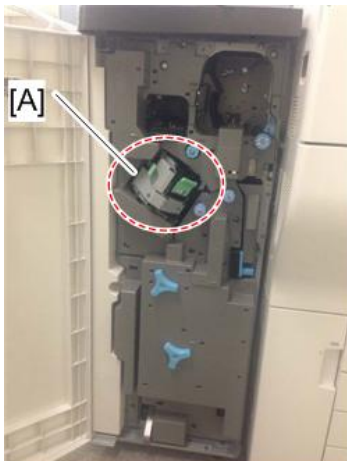

d135a0026

3. At the rear side, remove the screw circled in the photo below from the stapler [A].

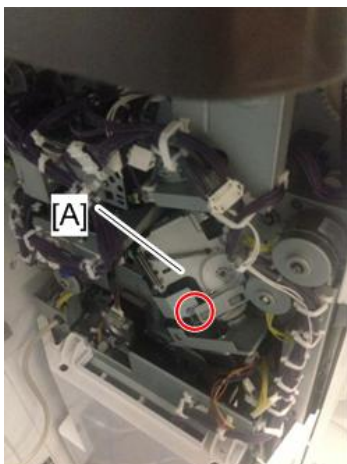

d135a0027

4. Push the stapler to the front side of the finisher.

1.Replacement and Adjustment

5. Remove the inner upper cover [A]. (🔩 x 2)



d135a0028

6. Pull out the stapler unit [A].

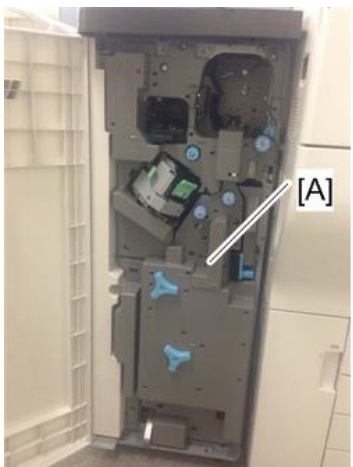

d135a0029

7. Remove the bracket [B] from the stapler [A]. (🔩 x 1)

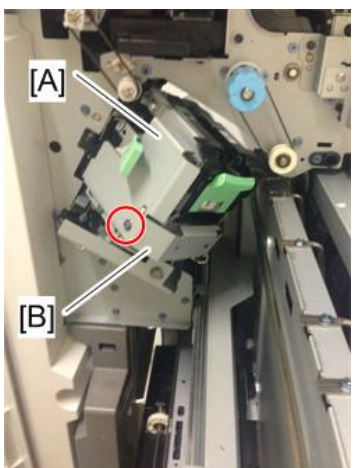

d135a0030

8. Remove bracket [A]. (🔧 x 1)

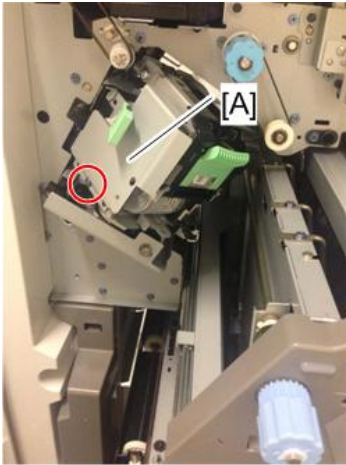

d135a0031

9. Remove the stapler [A]. (🔧 x 2)

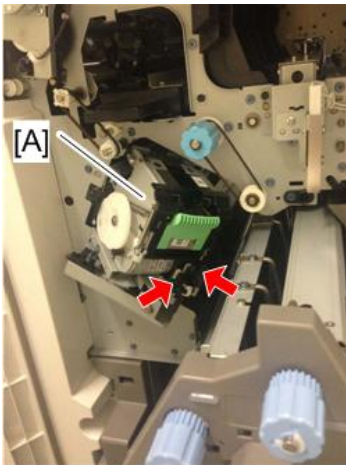

d135a0032

Punch Unit

Do not adjust the setting because the punch unit is adjusted in the factory. If replacing the parts of the punch unit is required, replace the whole unit.

Note

- Do not disassemble the punch unit. This unit is precisely adjusted in the factory.
 - Do not drop or give a shock to the unit when you replace it. The unit could be damaged.
1. Remove the following covers. [Rear Upper Cover](#), [Rear Lower Cover](#), [Upper Cover](#)
 - Rear Upper Cover
 - Rear Lower Cover
 2. Registration sensor bracket [A] (Ⓜ x 2, Ⓜ x 3, Ⓜ x 2)

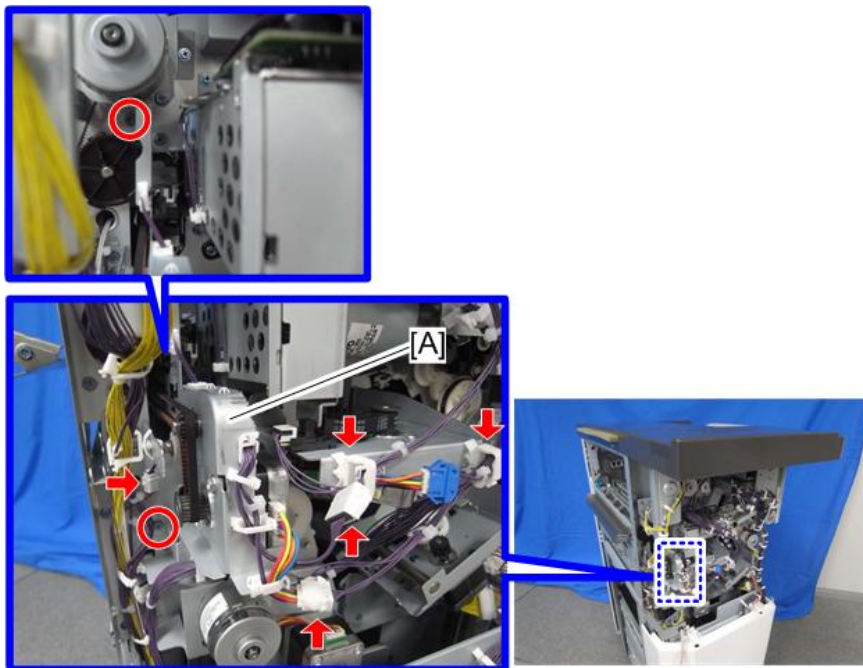

d1351312

3. Stepper motor bracket [A] (⚙️ x 1, 📦 x 2)

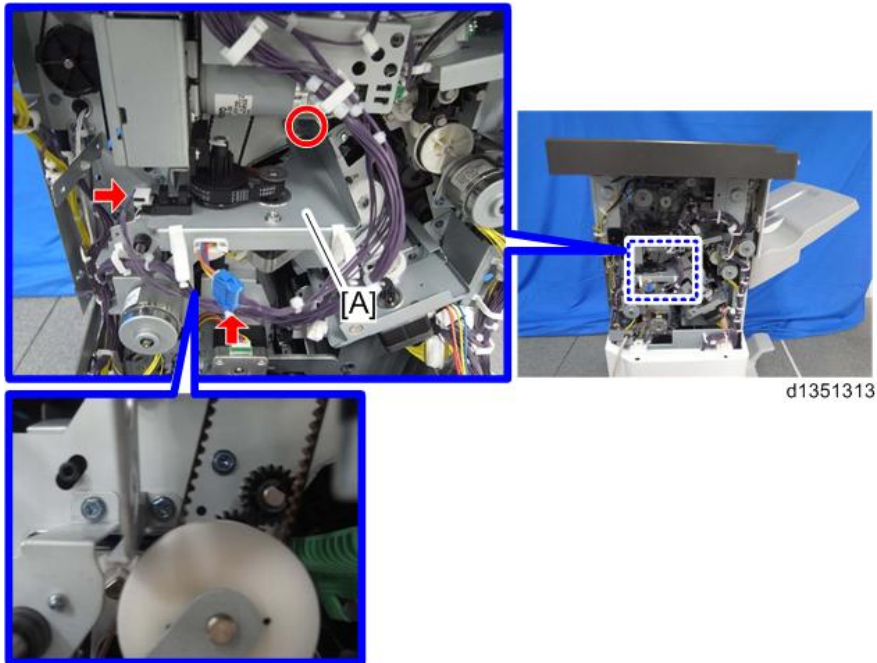

4. Remove punch unit control board [A] (⚙️ x1, ▼ x2).

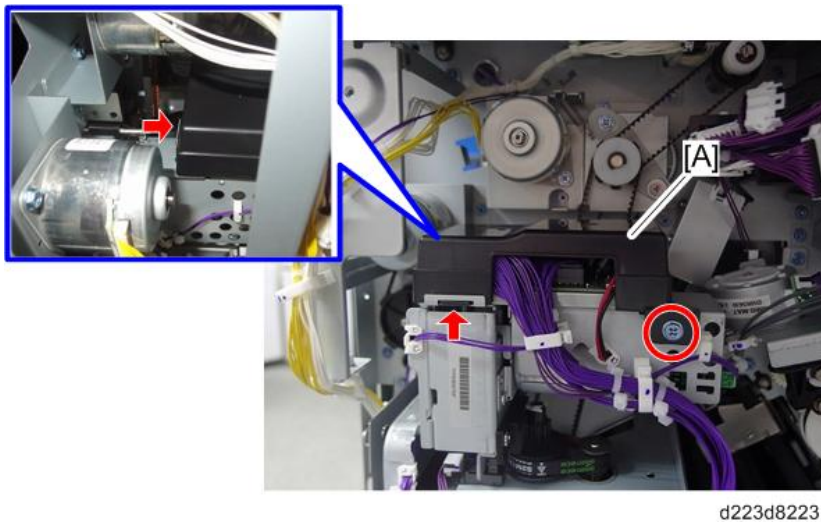

5. Pull out the punch unit [A] (⚙️ x 2, 📦 x 2, 🛠️ x 2)

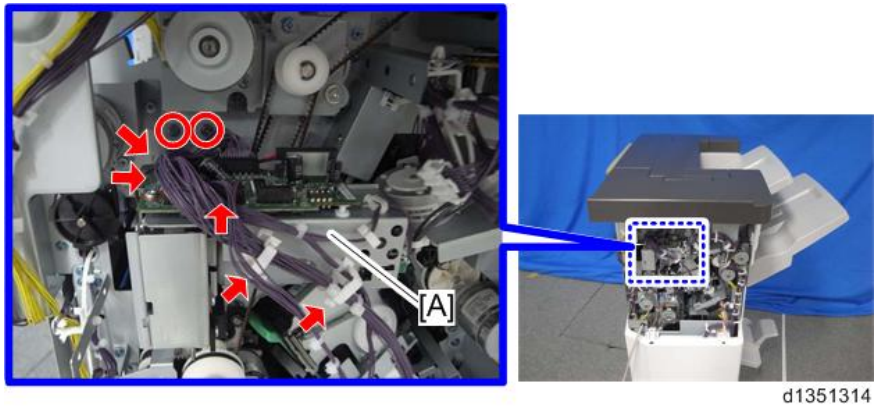

1.Replacement and Adjustment

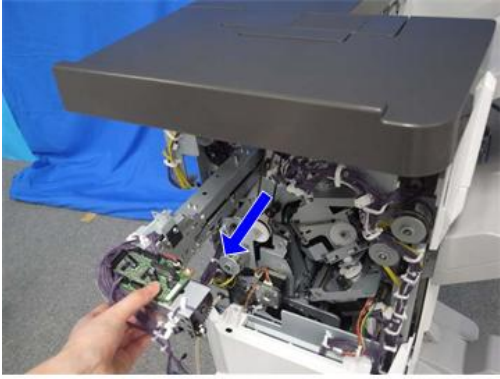

d1351315

Fold Adjustments

Flat Fold Roller Alignment

To adjust the folding strength, adjust the difference in vertical alignment between the flat fold rollers.

1. Booklet stapler unit [Booklet Stapler Unit](#)
2. Fold plate bracket [A] (🔑 x 2)

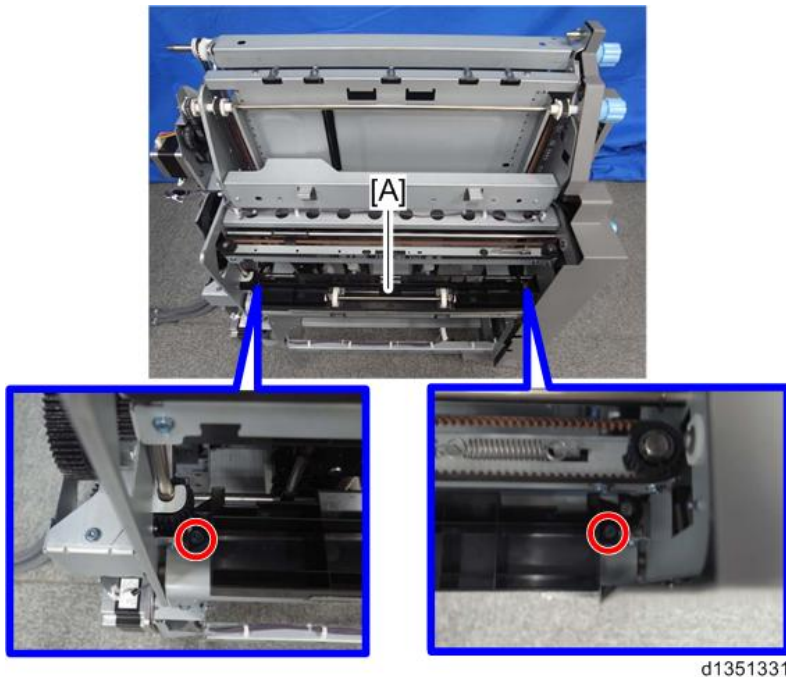

3. Open the bracket [A] of the flat fold roller.

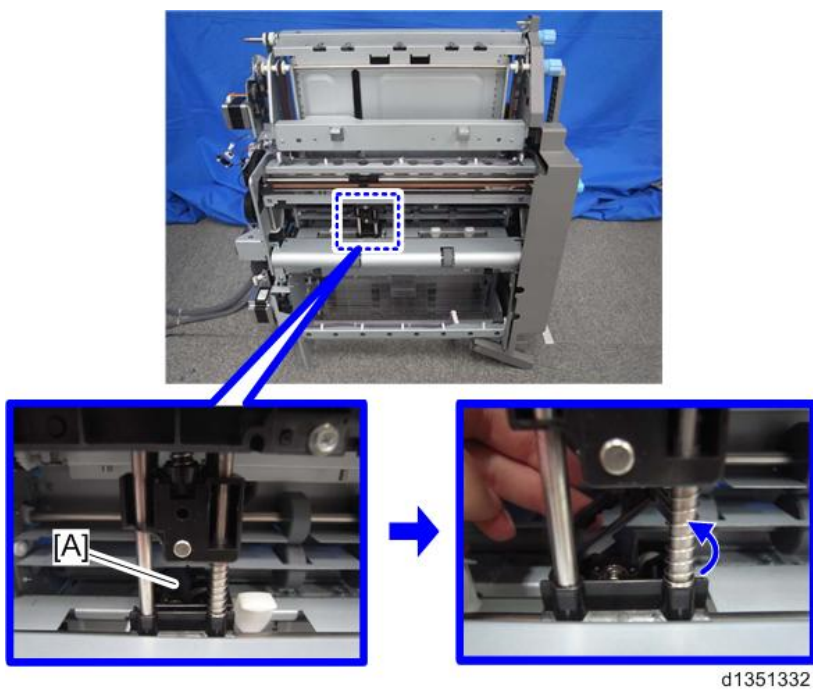

4. Change the position of the flat fold lower roller [A] to change the difference in alignment between the upper

1.Replacement and Adjustment

and lower rollers of the flat fold booklet unit.

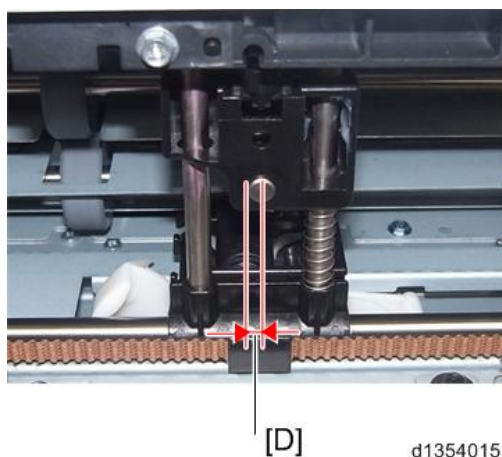
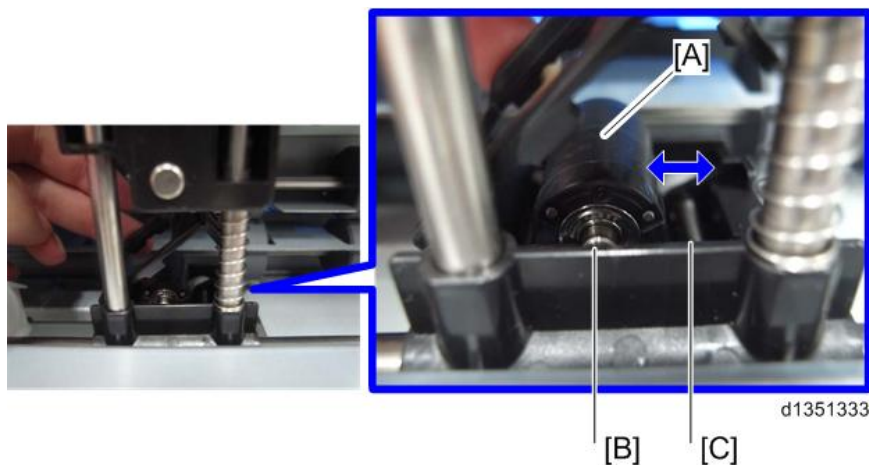

Note

- With the factory default, the upper and lower rollers of the flat fold booklet unit are not aligned vertically. There is a 3mm difference [D] between the upper and lower rollers. However, you can change the lower roller position from [B] (factory default) to [C]. If you change the lower roller position to [C], the difference becomes 0mm. In this condition, the upper and lower rollers are aligned vertically.
- If the toner does not stick well to the folding line of the booklet due to excessive folding strength, change the lower roller position to [C]. In this position, the booklet will be thicker than the factory default position.
- If you want increase the folding strength, the lower roller position should be [B] (factory default position). In addition, this will make the booklet thinner.
If you want to reduce the folding strength, the lower roller position should be [C] (the difference in alignment is 0mm). In addition, this will make the booklet thicker.

Difference in Alignment and Folding Strength

Difference in Alignment	Folding Strength	Thickness of the booklet	The amount of toner sticking to the folding line
3mm (default)	Strong	Thin	OK
0mm	Weak	Thick	Good

- Close the bracket after the adjustment.
- Reassemble the machine.

Adjusting the Folding Speed

You can adjust the thickness of the booklet by adjusting the moving speed of the flat fold booklet unit.

If you want to make the booklet thinner, set a slower speed. If you want to make the booklet thicker, set a faster speed.

- Enter the SP mode.
- Set the moving speed of the flat fold booklet unit for each paper size with SP6-114-001 to 010 (Fold Speed Adj.: 2K/3K FIN).

SP	Setting Items	Selection	Default Value
SP6-114-001	Fold Speed Adj.: 2K/3K FIN: A3 SEF	0: Standard (faster)	0: Standard
SP6-114-002	Fold Speed Adj.: 2K/3K FIN: B4 SEF	1: Middle (slow)	
SP6-114-003	Fold Speed Adj.: 2K/3K FIN: A4 SEF	2: Low (very slow)	
SP6-114-004	Fold Speed Adj.: 2K/3K FIN: B5 SEF		
SP6-114-005	Fold Speed Adj.: 2K/3K FIN: DLT SEF		
SP6-114-006	Fold Speed Adj.: 2K/3K FIN: LG SEF		
SP6-114-007	Fold Speed Adj.: 2K/3K FIN: LT SEF		
SP6-114-008	Fold Speed Adj.: 2K/3K FIN: 12"x18"		
SP6-114-009	Fold Speed Adj.: 2K/3K FIN: 8K SEF		
SP6-114-010	Fold Speed Adj.: 2K/3K FIN: Other		

- Exit the SP mode.

Flat Fold Booklet Unit Home Position Adjustment

- Pull out the stapling unit [A].



d1354010

1.Replacement and Adjustment

2. Timing gear [A] (⊗ x 1)



3. Turn the knob [A] clockwise to move the flat fold roller unit [B] in the direction of the arrow.

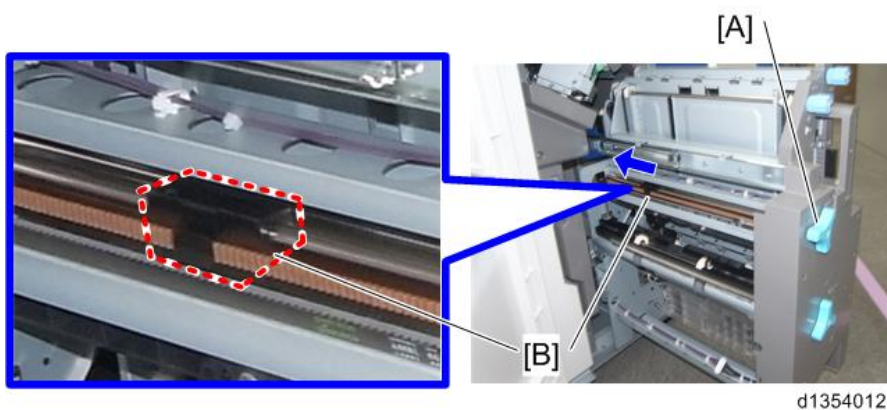

4. Move the flat fold roller unit until the edge of the unit [A] is between the guide lines [B] and [C] inscribed on the bracket.

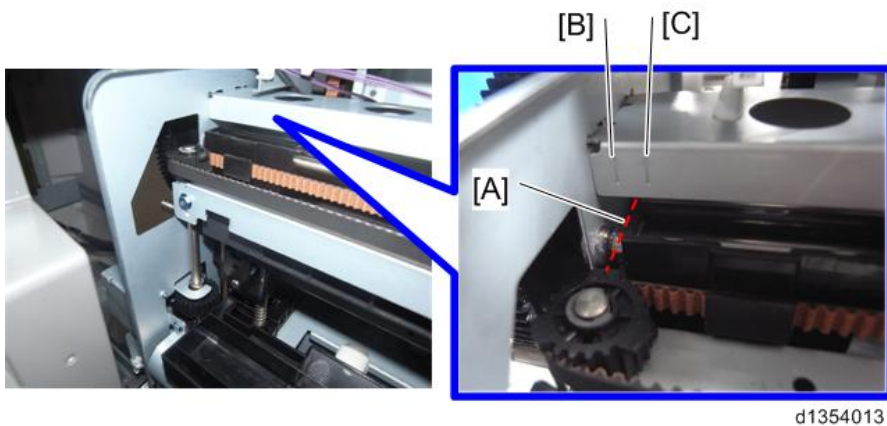

5. Check that the fold plate [A] has been moved in the direction of the arrow as far as it can go and the bushing

[B] on the rear end of the fold plate shaft [C] is aligned with the fold plate positioning cam [D].

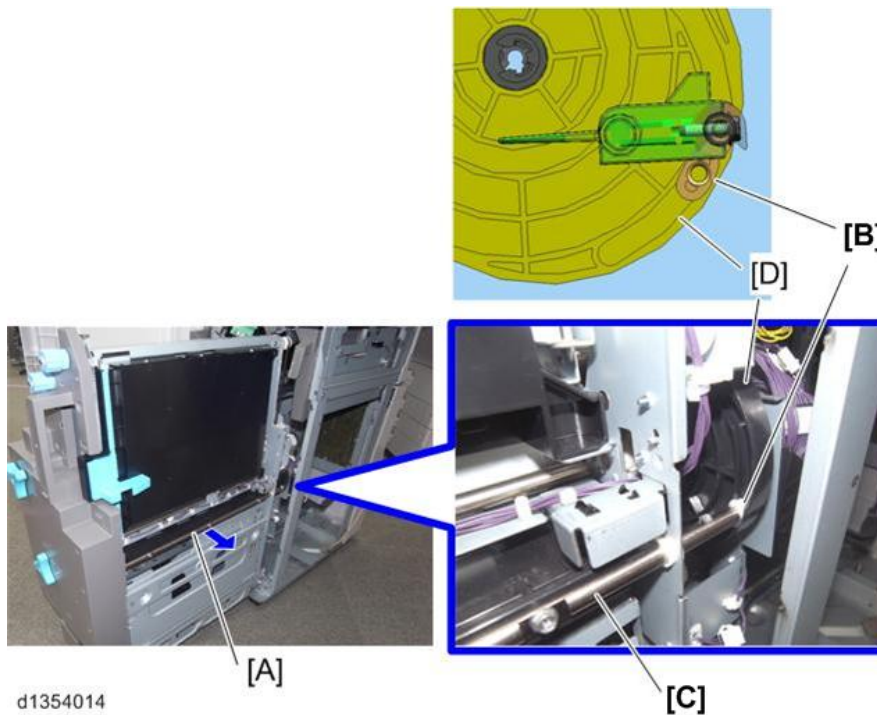

d1354014

6. Re-attach the timing gear [A] (⌀ x 1)



d1354011

7. Reassemble the finisher and connect it to the copier.
8. Turn on the copier.
9. After the finisher initialization is complete, check that the flat fold roller unit, fold plate and the cam are positioned as described in steps 4 and 5.

Paper Guide Unit

Paper Exit Cover, Optional Output Jogger Unit

The paper exit covers must be removed before the paper guide unit can be removed. Removal of these covers is different, depending on whether the Output Jogger Unit Type M25 is installed.

- If the optional output jogger unit is not installed, do Procedure 1 below. It is necessary to remove only the paper exit cover.
- If the optional jogger unit is installed, do Procedure 2 below. It is necessary to remove the optional jogger unit as well as the paper exit covers.

Procedure 1: Optional output jogger unit not installed

1. Disconnect the finisher from the main frame.
2. Remove the rear cover.

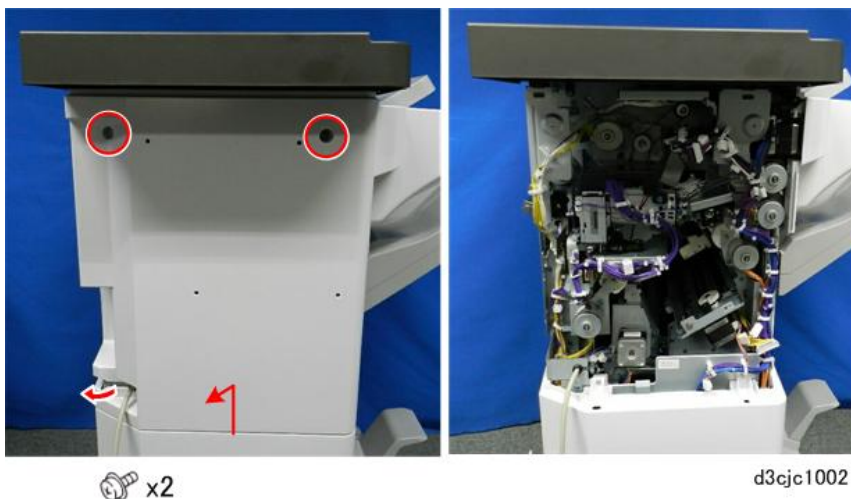

3. Remove the shift tray.



4. Push the paper guides to the center.

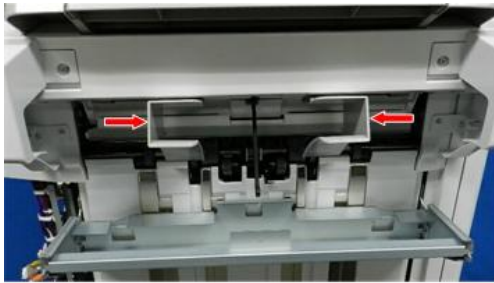

d3cjc1004

5. Remove the rear paper guide cover.

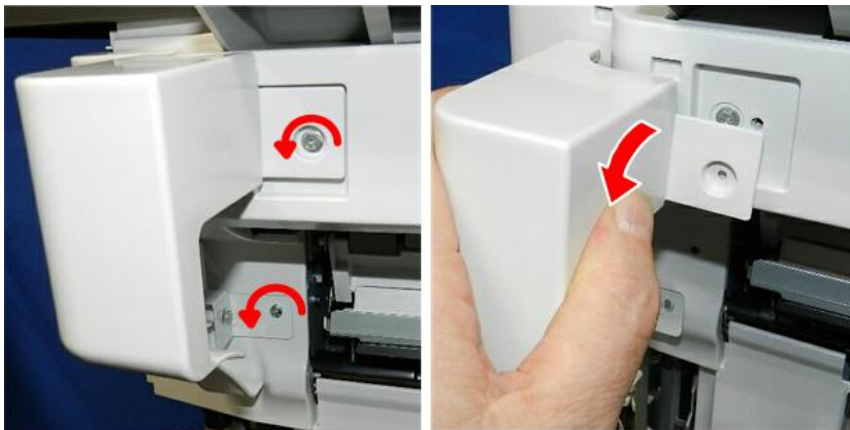

 x2

d3cjc1005

6. Remove the front paper guide cover.

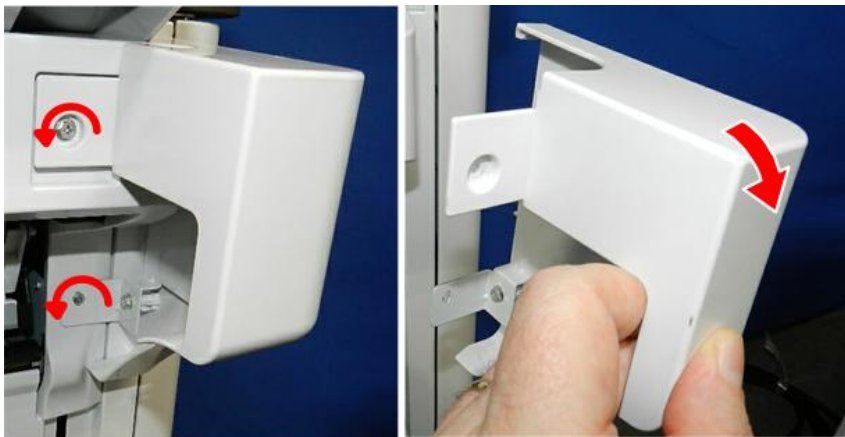

 x2

d3cjc1006

1.Replacement and Adjustment

7. Disconnect the main paper guide cover.



 x2

d3cjc1007

8. Carefully, separate the front tabs at [A], and then remove the main paper guide cover [B].



d3cjc1008

Procedure 2: Optional output jogger unit installed

1. Remove the rear cover.

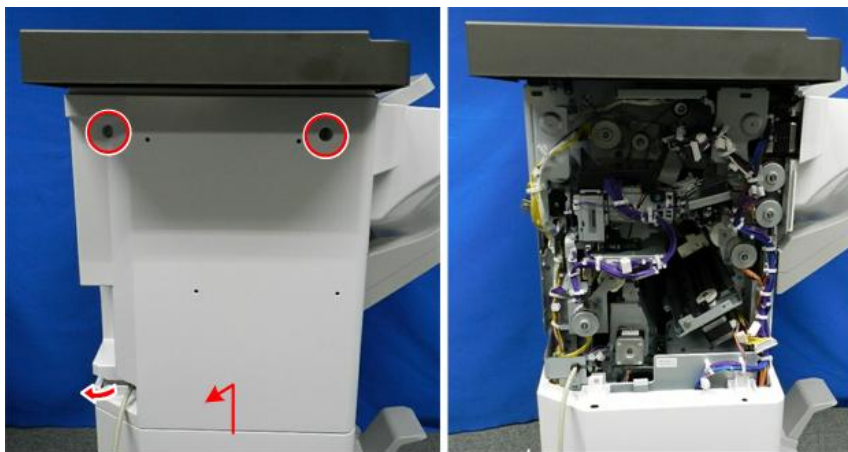

 x2

d3cjc3001

2. Remove the shift tray.

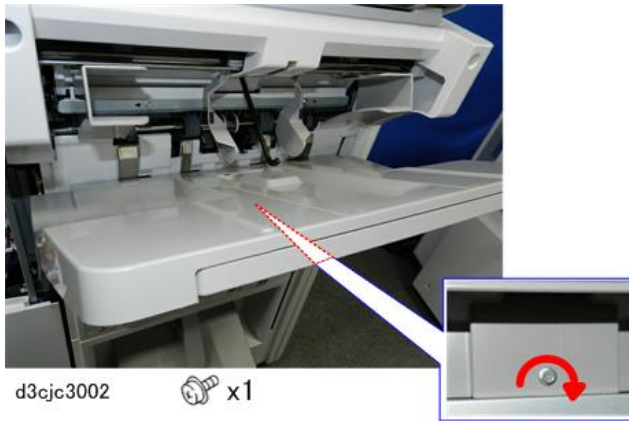

3. Disconnect the jogger unit cover at the front [A] and rear [B].



4. Below the front end of the jogger unit cover [A], loosen the screw (do not remove).
5. Pull the V-notch of the arm [B] out from under the loosened screw.

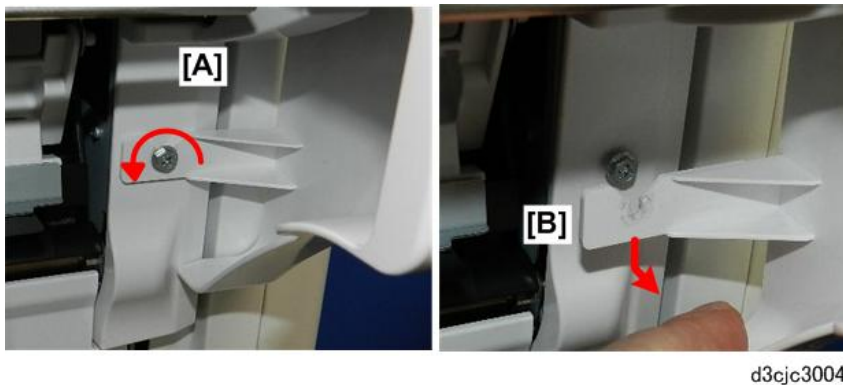

6. Remove the jogger unit cover.



1.Replacement and Adjustment

7. Remove rear end cover [A] and front end cover [B].

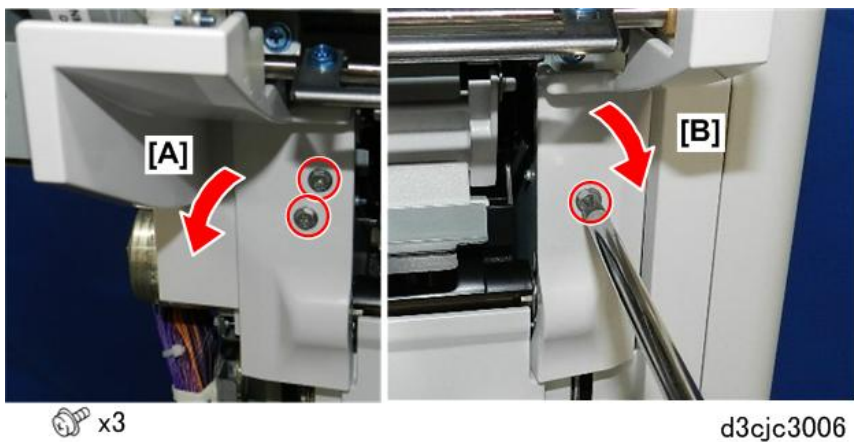

8. At the rear, disconnect the jogger unit.

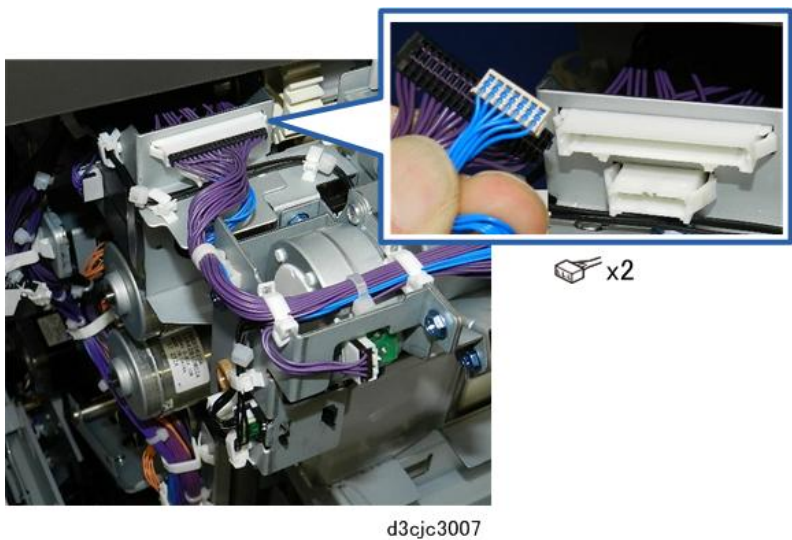

9. Disconnect the jogger unit at the front and rear.

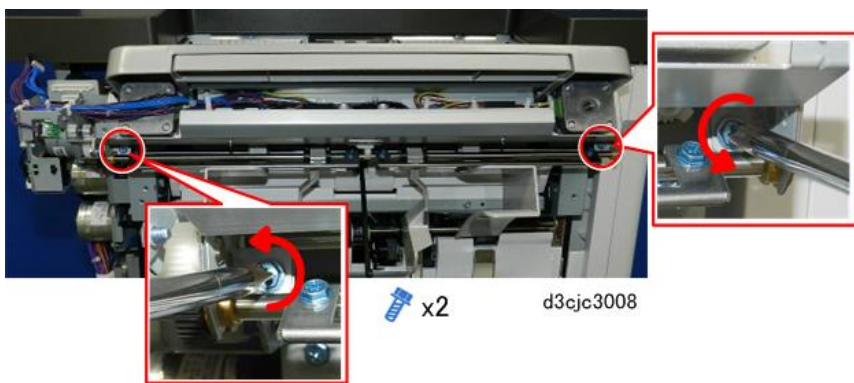

10. The jogger unit hangs on two shoulder screws [A] (one at the front and one at the end).

11. Lift the jogger unit [B] off the shoulder screws and remove it.



12. Lay the jogger unit on a flat, clean surface.



Paper Guide Unit

1. Remove the paper exit covers if the optional output jogger unit is not installed. (Procedure 1: Optional output jogger unit not installed)
-or-
If the optional output jogger unit is installed, remove it. (Procedure 2: Optional output jogger unit installed)
2. Disconnect the cover support bracket.



1.Replacement and Adjustment

3. Remove the cover support bracket.



d3cjc1010

4. **Loosen** (do not remove) the screws on both ends of the paper exit. This will loosen the tray so that you can move the tray slightly side-to-side in order to remove the bracket screws more easily.

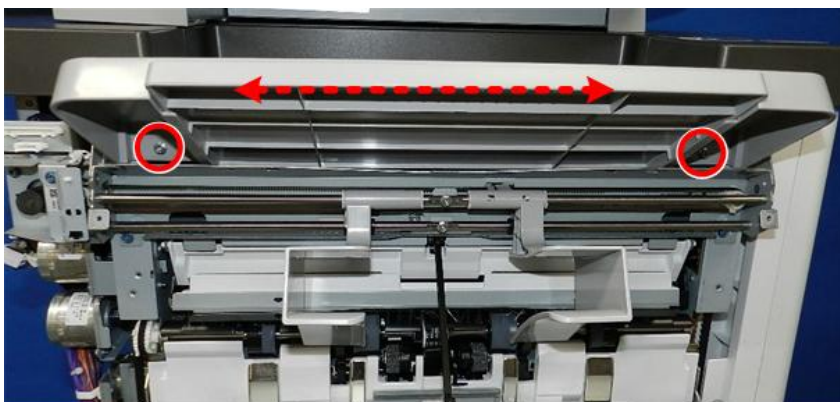

d3cgc3001

5. Disconnect the rear end of the paper guide unit bracket [A].
6. Disconnect the front end of the paper guide unit bracket [B].

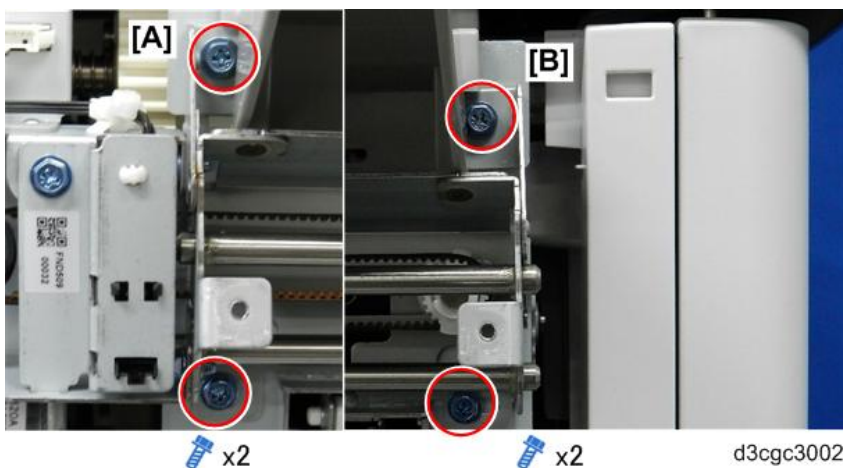

7. At the rear, open the clamps and disconnect the motor and sensor harnesses.

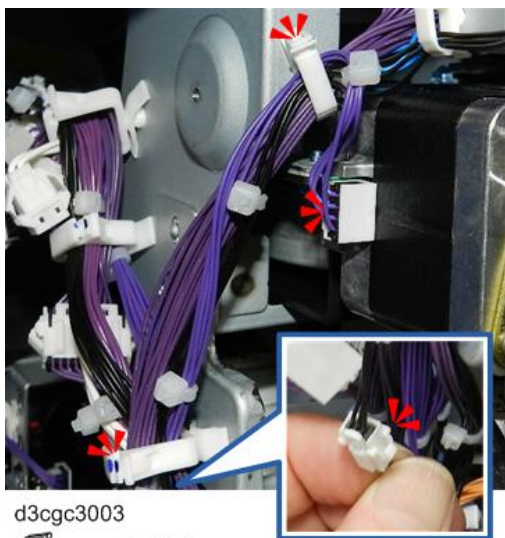

 x2  x2

8. Hold the unit bracket with both hands, lower the rear end [A], roll it toward you slightly, and then disconnect the harnesses [B].

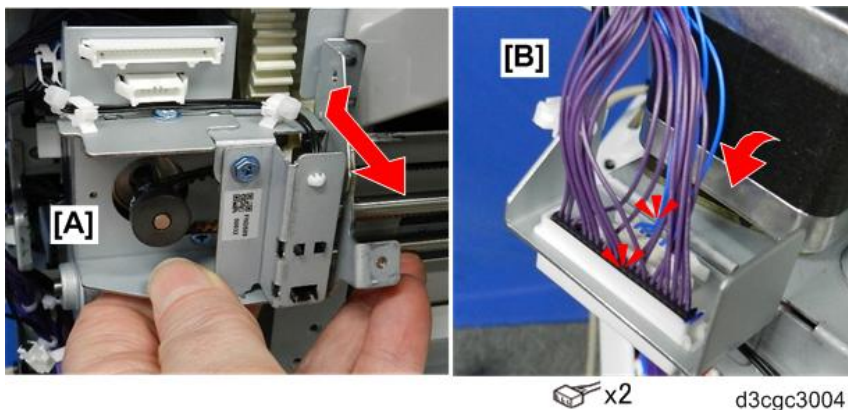

9. Lay the unit on a flat clean surface so that you can see the paper guide motor [1] and paper guide position sensor bracket [2].

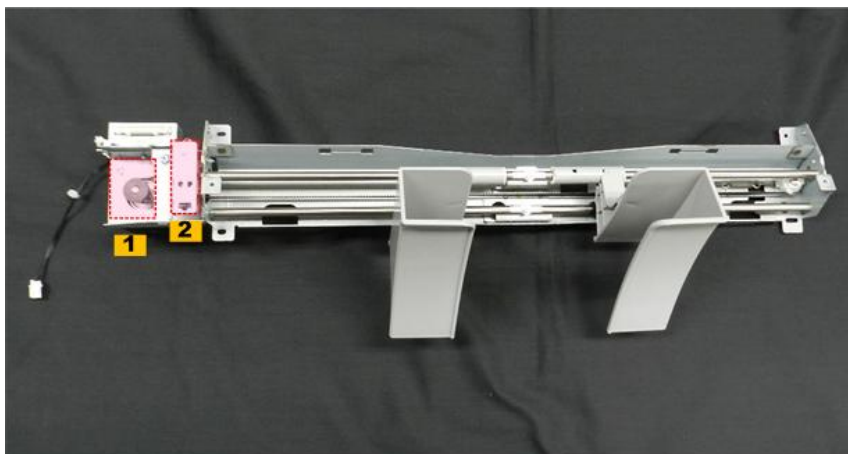

d3cgc3005

1.Replacement and Adjustment

Paper Guide Unit Sensor

1. Remove the paper guide unit. [Paper Guide Unit](#)
2. Disconnect the sensor bracket.





 x1

d3cgc3006

3. Disconnect the sensor.



 x1  x1

d3cgc3007

4. Separate the sensor and bracket.

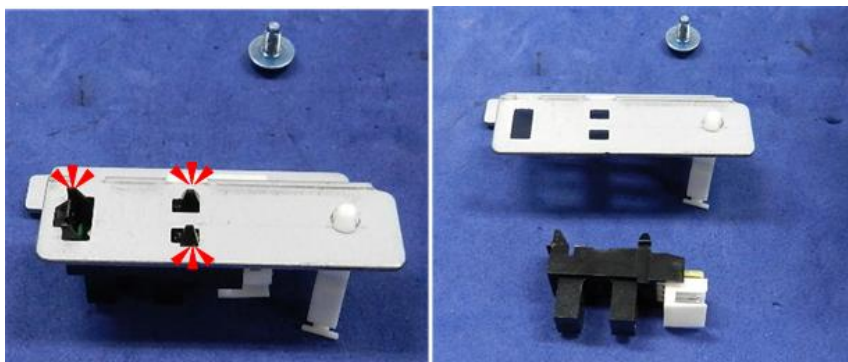

1x3

d3cgc3008

Paper Guide Motor

1. Remove the paper guide unit. [Paper Guide Unit](#)
2. Disconnect the sensor bracket so that you can access the screw below.

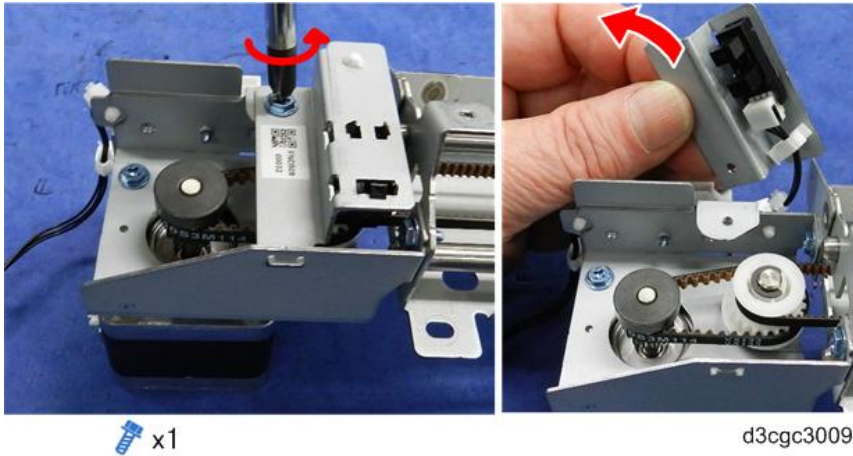

3. Disconnect the motor.

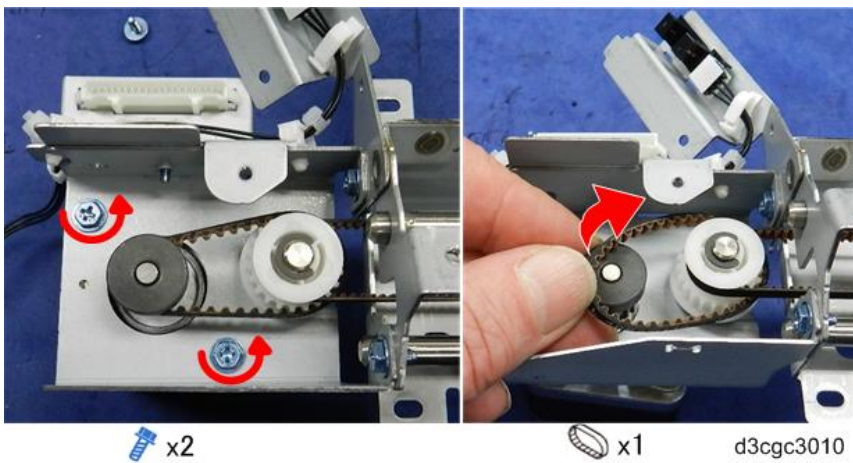

4. Separate the unit from the motor.

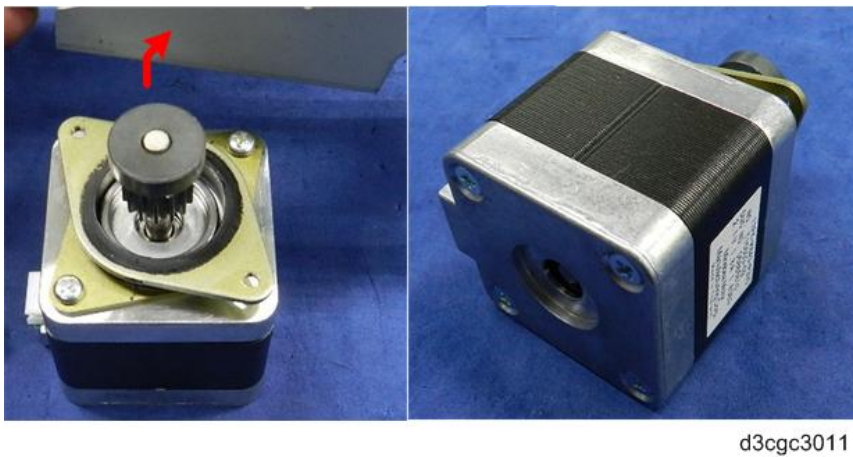

1.Replacement and Adjustment

5. When you re-install the motor, make sure the open bracket connector is pointing to the rear.



d3cgc3012

2. Detailed Descriptions

Overview

Layout

General Layout

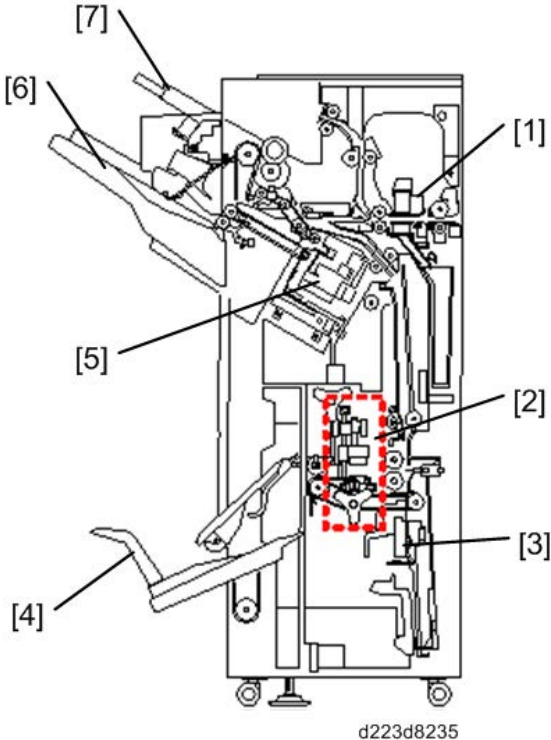

No.	Name	No.	Name
1	Punch Units	5	Corner Stapler
2	Side-to-Side Fold Roller	6	Shift Tray
3	Booklet Stapler	7	Proof Tray
4	Booklet Staple Tray	-	-

Note

- When pushing the booklet stapler unit into the finisher, make sure that the unit is against the frame, as shown in the blue circle, and that jam release lever R8 is closed completely.

2.Detailed Descriptions

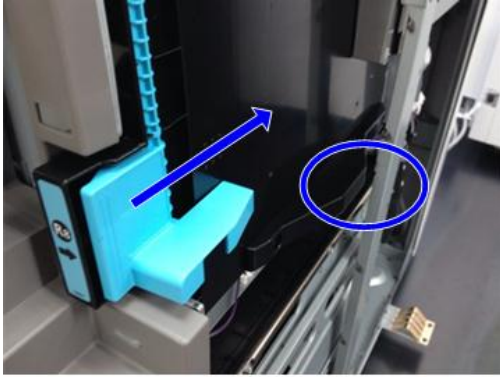

d1359970

Electrical Component Layout

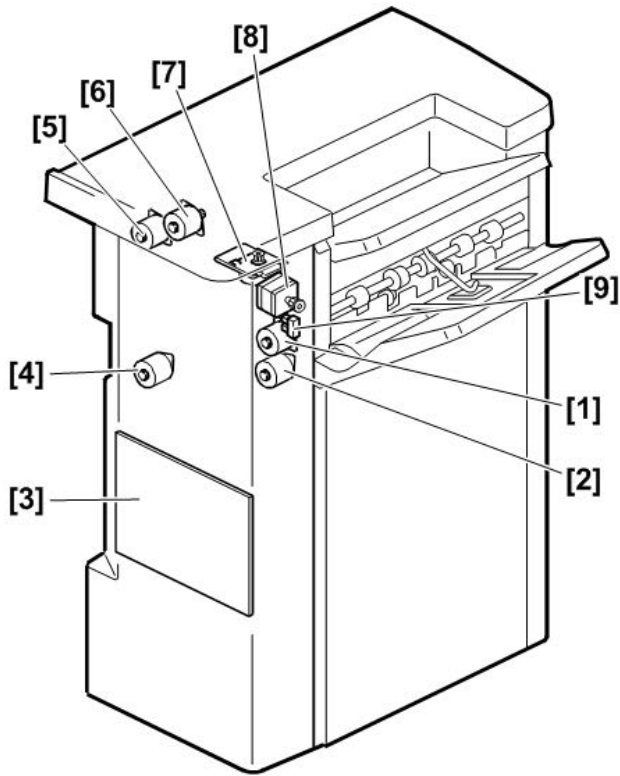

d223d8236

No.	Part
1	Exit Motor
2	Transport Motor
3	Main Control Board
4	Pre-stack Transport Motor
5	Entrance Transport Motor
6	Horizontal Transport Motor
7	Tray Lift Motor

No.	Part
8	Paper Guide Motor
9	Paper Guide HP Sensor

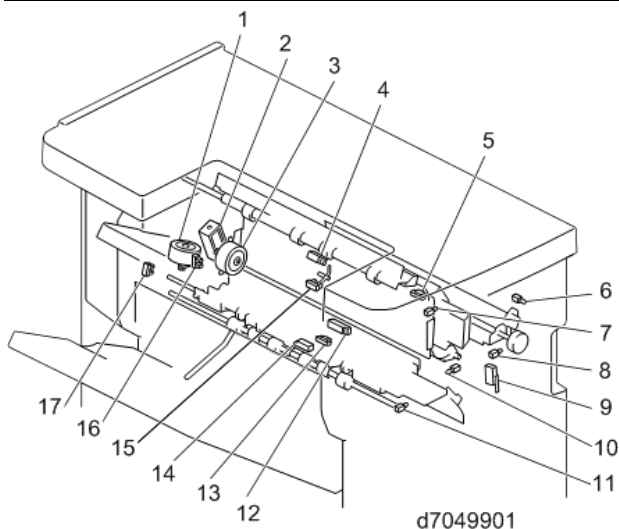

No.	Part	No.	Part
1	Shift Motor	10	LED 3
2	Upper Junction Gate Solenoid	11	LED 2
3	Lower Junction Gate Motor	12	Horizontal Transport Sensor
4	Proof Tray Full Sensor	13	Switchback Transport Sensor
5	Entrance Sensor	14	Transport Path Paper Sensor
6	LED 5	15	Proof Tray Exit Sensor
7	LED 1	16	Lower Junction Gate JP Sensor
8	LED 4	17	Shift Roller HP Sensor
9	Front Door Switch		

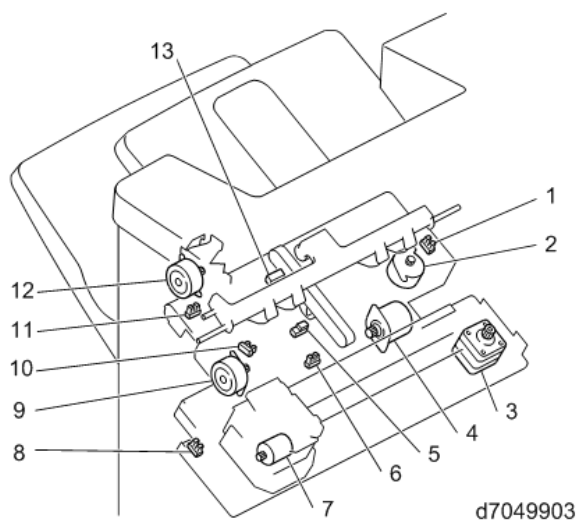

2.Detailed Descriptions

No.	Part	No.	Part
1	Jogger Fence HP Sensor	8	Stapler Move HP Sensor
2	Jogger Motor	9	Leading Edge Guide Motor
3	Corner Stapler Movement Motor	10	Leading Edge Guide HP Sensor
4	Feed-out Belt Motor	11	Positioning Roller HP Sensor
5	Staple Tray Paper Sensor	12	Positioning Roller Motor
6	Feed-out Belt HP Sensor	13	Shift Tray Exit Sensor
7	Corner Stapler Motor		

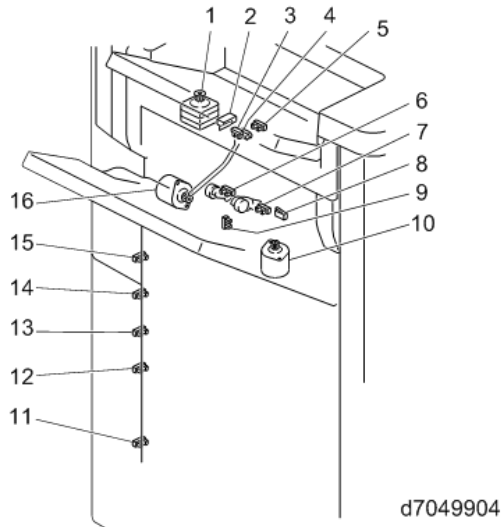

No.	Part	No.	Part
1	Paper Exit Guide Plate Motor	9	Return Roller HP Sensor
2	Paper Exit Guide Plate Limit Switch	10	Return Roller Motor
3	Booklet Stack Height Sensor 1	11	Shift Tray Lower Limit Sensor 5
4	Booklet Stack Height Sensor 2	12	Shift Tray Lower Limit Sensor 4
5	Exit Guide Plate HP Sensor	13	Shift Tray Lower Limit Sensor 3
6	Trailing Edge Press HP Sensor	14	Shift Tray Lower Limit Sensor 2
7	Shift Paper Height Sensor	15	Shift Tray Lower Limit Sensor 1
8	Upper Tray Height Limit Switch	16	Trailing Edge Press Motor

Booklet Finisher SR4130 Electrical Components

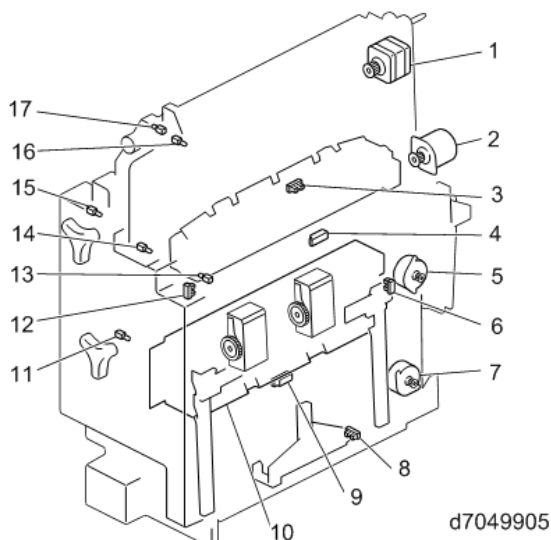

No.	Part	No.	Part
1	Booklet Jogging Pawl Movement Motor	10	Booklet Stapler Motor
2	Dynamic Roller Transport Motor	11	Booklet LED 1
3	Booklet Jogging Pawl HP Sensor	12	Booklet Guide Plate Sensor
4	Booklet Upper Transport Path Stack Sensor	13	Booklet LED 2
5	Booklet Jogger Motor	14	Booklet LED 3
6	Booklet Jogging HP Sensor	15	Booklet LED 4
7	Booklet Bottom Fence Motor	16	Booklet LED 5
8	Booklet Trailing Edge Bottom Fence HP Sensor	17	Booklet LED 6
9	Booklet Lower Transport Path Stack Sensor		

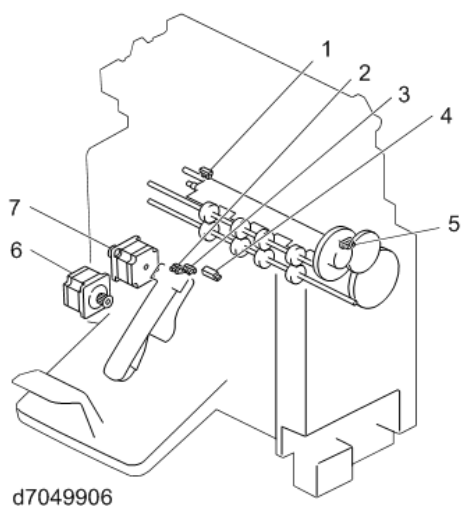

No.	Part
1	Fold Plate HP Sensor
2	Booklet Tray Full Sensor 2
3	Booklet Tray Full Sensor 1

2.Detailed Descriptions

No.	Part
4	Booklet Exit Sensor 1
5	Fold Plate Cam HP Sensor
6	Fold Transport Motor
7	Press Fold Motor

Punch Units

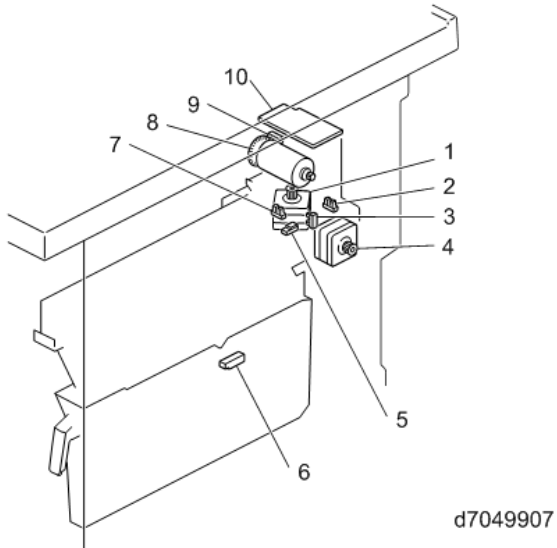

No.	Part
1	Punch Movement Motor
2	Punch Unit HP Sensor
3	Punch Registration HP Sensor
4	Punch Registration Motor
5	Punch Registration Sensor
6	Punchout Hopper Full Sensor
7	Punch HP Sensor
8	Punch Motor
9	Punch Motor Rotation Sensor
10	Punch Unit Control Board

Transport Layout

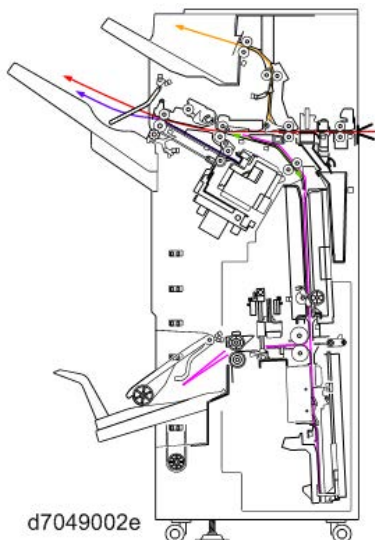

Red	Straight Through Path
Orange	Proof Path
Green	Pre-stack Path
Purple	Corner Staple Path
Pink	Booklet Staple Path

Proof Transport Layout (Drive)

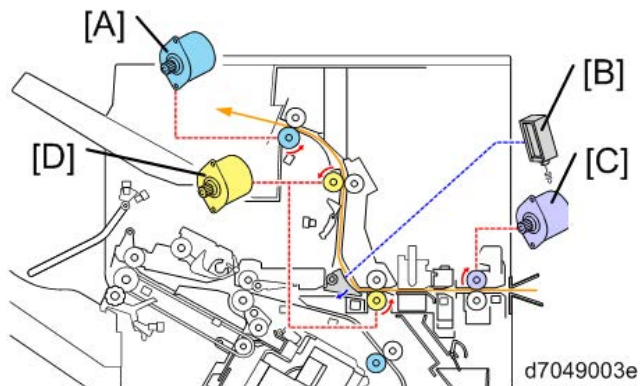

No.	Name
A	Proof Exit Motor
B	Junction Gate Solenoid
C	Entrance Transport Motor
D	Horizontal Transport Motor

2.Detailed Descriptions

Proof Transport Layout (Sensor)

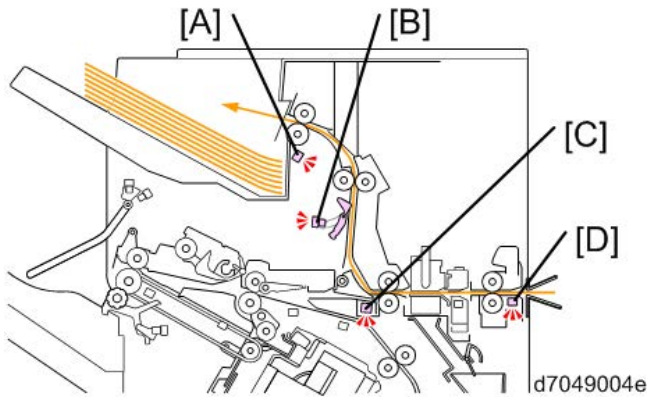

No.	Name
A	Proof Tray Full Sensor
B	Proof Exit Sensor
C	Horizontal Transport Sensor
D	Entrance Sensor

Shift Transport Layout (Drive)

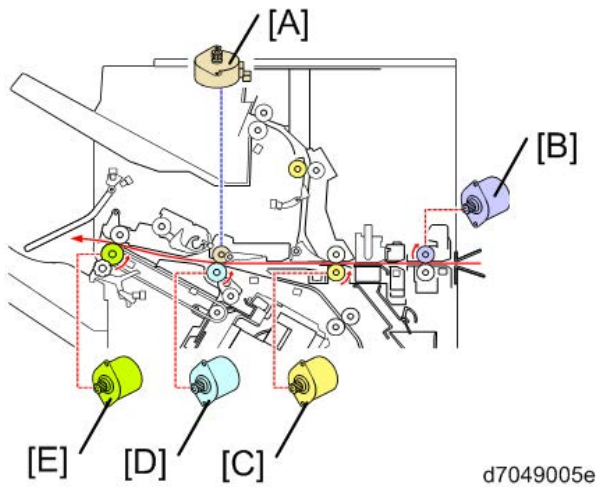

No.	Name
A	Shift Roller Motor (shift only)
B	Entrance Transport Motor
C	Horizontal Transport Motor
D	Relay Transport Motor
E	Upper Tray Exit Motor

Operation Details

Shift Operation (Shift Transport)

To output paper, the shift roller motor [A] moves the shift roller [B] side-to-side while a job is in progress. The shift roller HP sensor [C] is used to control this mechanism.

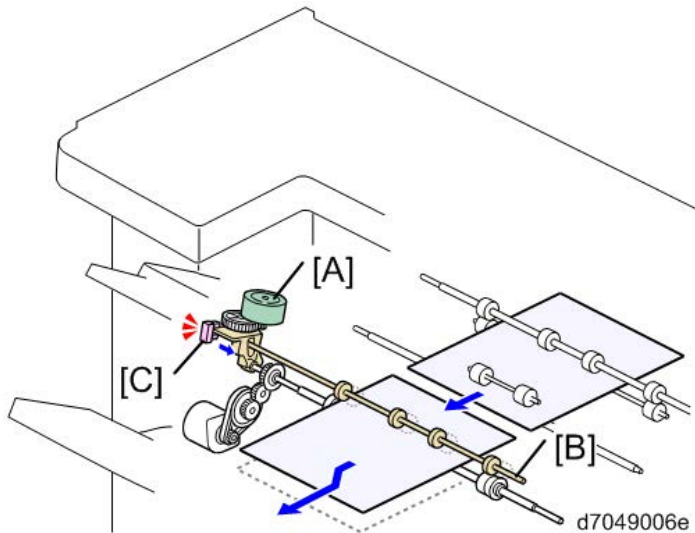

Pre-stack Operation (In Corner Stapling)

- **Pre-stack Capacity:** 1 sheet
- **Pre-stack Size:** A4 SEF/LEF, B5 SEF/LEF, LT SEF/LEF

There are four steps as follows:

1. The upper tray exit guide plate [A] shifts up (open). Paper comes through the entrance transport path and reaches the relay transport path.

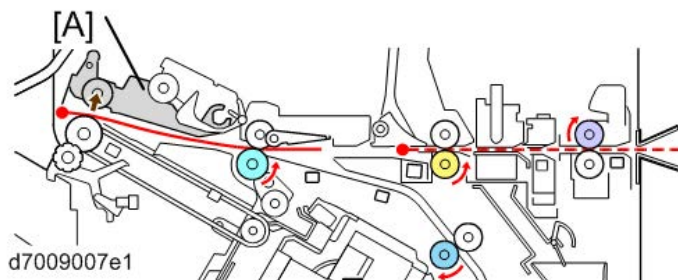

2. After the paper passes the pre-stack junction gate [A], the pre-stack junction gate [A] shifts down (closed) and the relay transport roller [C] rotates in reverse. The pre-stack roller [B] rotates to feed the paper to the

2.Detailed Descriptions

pre-stack position.

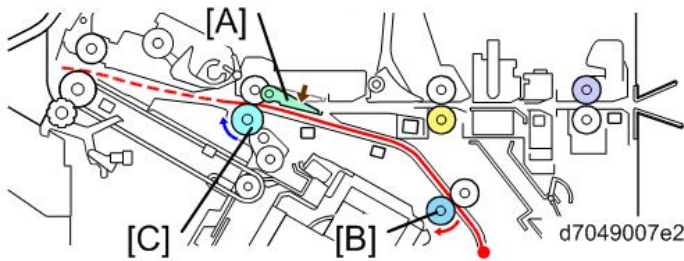

3. The rotation of the relay transport roller [C] and the pre-stack roller [B] stops, and the pre-stack junction gate [A] shifts up (open). The shift roller [D] also shifts up to release the pressure between itself [D] and the relay transport roller [C].

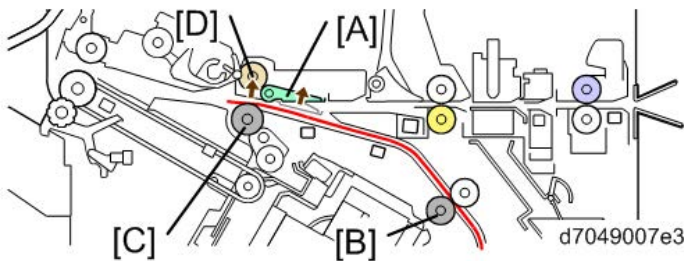

4. The following sheet of paper comes through the entrance and reaches the relay transport path. After that, the shift roller [A] drops in order to press the pre-stacked sheet and the following sheet. Then the two sheets go to the next process (corner stapling).

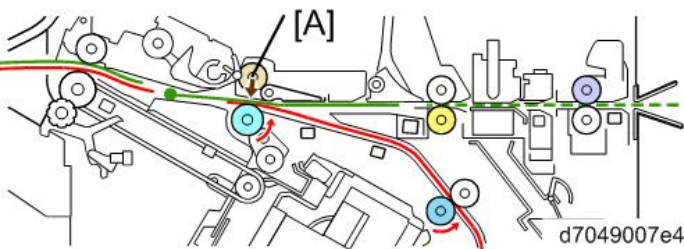

Pre-stack Operation (Booklet Stapling)

- **Pre-stack Capacity:** 2 sheet
- **Pre-stack Size:** All Sizes

There are five steps as follows:

1. The upper tray exit guide plate [A] shifts up (open). Paper comes through the entrance transport and reaches the relay transport path.

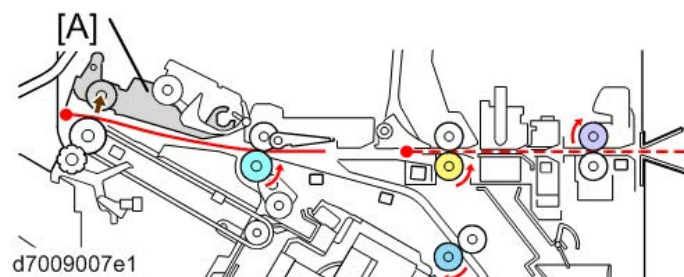

- The pre-stack junction gate [A] drops (closed) and the relay transport roller [C] rotates in reverse. The pre-stack roller [B] rotates to feed paper to the pre-stack position.

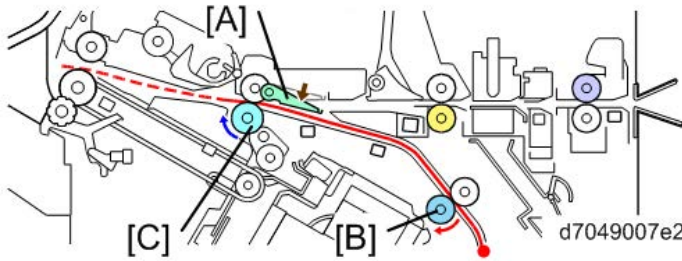

- The rotation of the relay transport roller [C] and the pre-stack roller [B] stops, and the pre-stack junction gate [A] shifts up (open). The shift roller [D] shifts up to release the pressure between itself [D] and the relay transport roller [C].

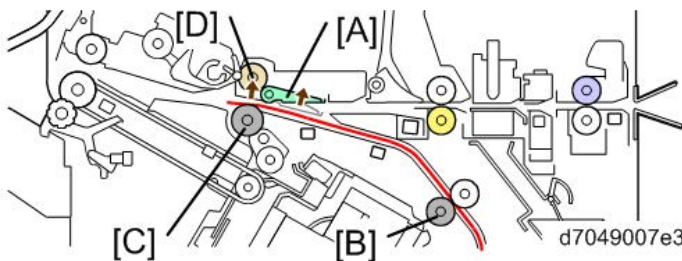

- The following sheet comes through the entrance and reaches the relay transport path. After that, the shift roller [A] drops to press the pre-stacked sheet and the following sheet. The two sheets are fed part of the way out.

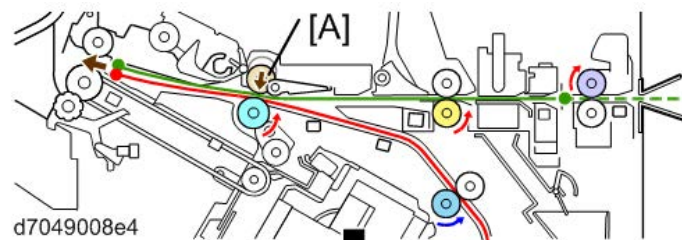

- The pre-stack junction gate [B] drops (closed) again, the relay transport roller [A] rotates in reverse, and the pre-stack roller [C] rotates to send the two sheets of paper to the booklet stapling path.

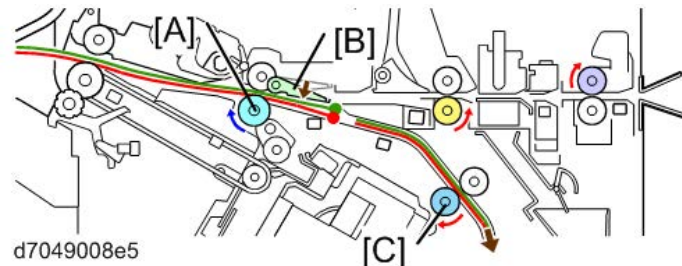

Upper Tray Shift Drive / Limit Sensor / Full Sensor

Upper Tray Shift Up/down

The upper tray lift motor [A] moves the upper tray up/down.

2.Detailed Descriptions

Upper Position Detection

With the actuator, the limit sensor [B] detects when the tray is at its highest position (without output paper). The forced stop switch (interlock SW) [C] prevents the tray from moving up too far. When the upper tray moves up to the highest position but doesn't stop, the forced stop switch is pushed and the tray shift motor [A] stops.

Upper Tray Full Detection

Condition 1

There are five tray full sensors [D] on the rear side of the machine. The machine uses the readings from these sensors to detect how many outputs are stacked in the tray.

SR4130: Three sensors to detect 500, 1000, 2000 sheets

SR4120: Three sensors to detect 500, 1500, 3000 sheets

Booklet Finisher SR4130

Detection	Sensors	Paper Size	Length
500 sheets full	Shift Tray Lower Limit Sensor 5	A5 SEF, A5 LEF, B6 SEF, HLT LEF, A6 SEF	148 to 182 mm
1,000 sheets full	Shift Tray Lower Limit Sensor 4	A3 SEF, A4 SEF, B4 SEF, B5 SEF, B5 LEF, DLT SEF, LG, SEF, LT SEF, 12"x18" SEF, SRA3,13"x19.2" SEF	182 to 488 mm
2,000 sheets full	Shift Tray Lower Limit Sensor 2	A4 LEF, LT LEF	

Finisher SR4120

Detection	Sensors	Paper Size	Length
500 sheets full	Shift Tray Lower Limit Sensor 5	A5 SEF, A5 LEF, B6 SEF, HLT SEF, A6 SEF	148 to 182 mm
1,500 sheets full	Shift Tray Lower Limit Sensor 3	A3 SEF, A4 SEF, B4 SEF, B5 SEF, B5 LEF, DLT SEF, LG SEF, LT SEF, 12"x18" SEF, SRA3 SEF, 13"x19.2" SEF	182 to 488 mm
3,000 sheets full	Shift Tray Lower Limit Sensor 1	A4 LEF, LT LEF	

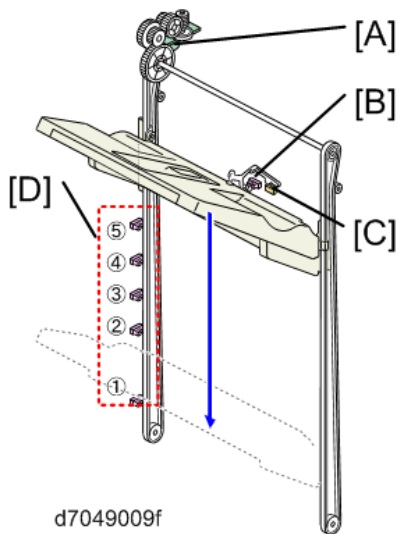

d7049009f

Condition 2

When the feeler is pushed up as far as "1", and remains there for 13 sec., the tray is detected full. The purpose is to accurately detect "tray full" for stacks of Z-folded paper, or poorly stacked documents.

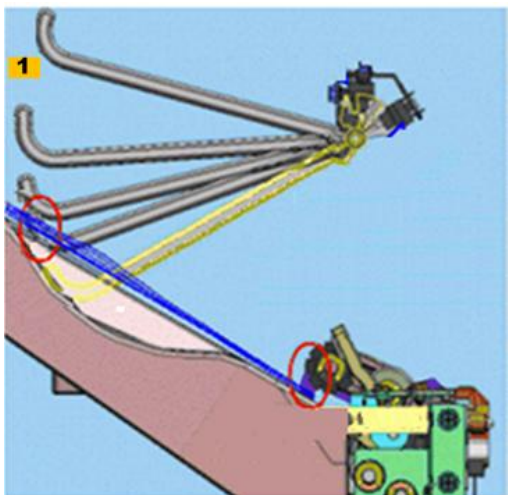

d3cgc3014

Condition 3

Shift tray detection input check: SP6123-35 is normally set to "0" (default), tray not full.

Pull-in Roller / Paper Stack Holder

Components

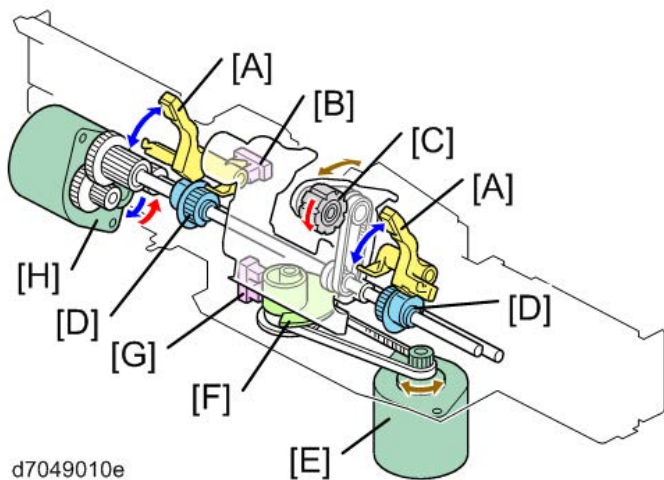

d7049010e

No.	Name	No.	Name
A	Paper Stacking Holder	E	Stacking Sponge Roller Fluctuation Motor
B	Holder HP Sensor	F	Stacking Sponge Roller Cam
C	Stacking Sponge Roller	G	Stacking Sponge Roller HP Sensor
D	Paper Stacking Holder Cam	H	Paper Stacking Holder Motor

2.Detailed Descriptions

Operation

There are five steps in the operation:

1. When a job starts, the paper stacking holder motor rotates the paper stacking holder cam [B] to shift the paper stacking holder [A] down.
2. The stacking sponge roller fluctuation motor rotates the stacking sponge roller cam [D] to move the stacking sponge roller [E] down. The paper stacking holder motor rotates the paper stacking holder cam [B] to lift the paper stacking holder [A] up to its HP (until the paper stacking holder interrupts the paper stacking holder HP sensor [C]).

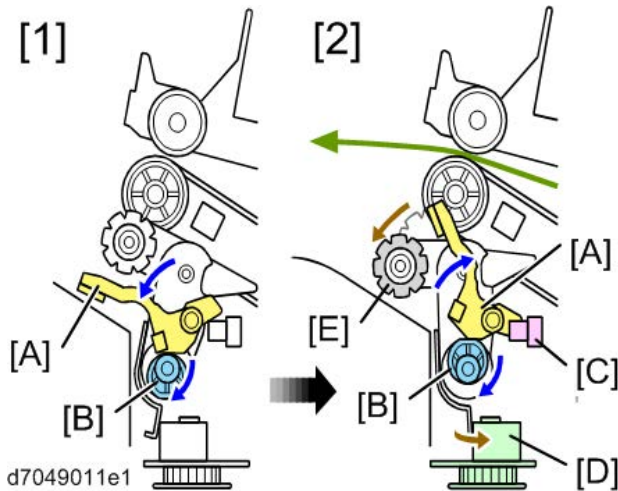

3. The paper stacking holder motor drives in reverse to let the stacking sponge roller [A] pull the output paper in.
4. The paper stacking holder motor rotates the paper stacking holder cam [C] to drop the paper stacking holder [B] down (until the end of the job, the machine repeats step 3 and step 4).

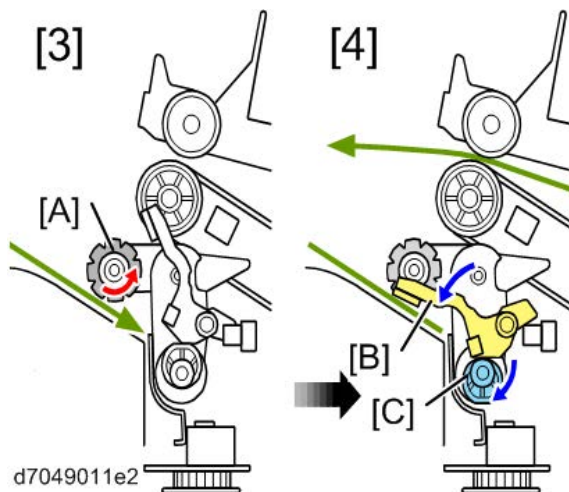

5. After a job end, the stacking sponge fluctuation motor rotates the stacking sponge roller cam [D] to lift the stacking sponge roller [A] up to its HP position. At the same time, the paper stacking holder motor rotates the holder cam [E] to lift the paper stacking holder [B] up to its HP (until the paper stacking holder HP sensor

[C] detects the end of the paper stacking holder [B]).

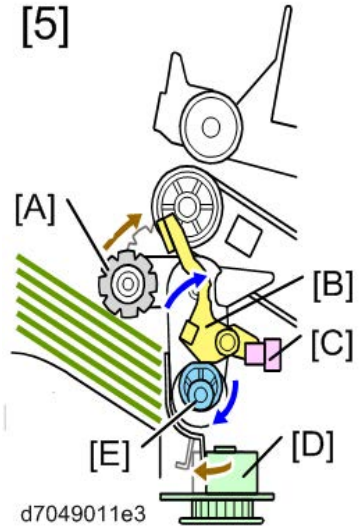

Corner Stapling

Components

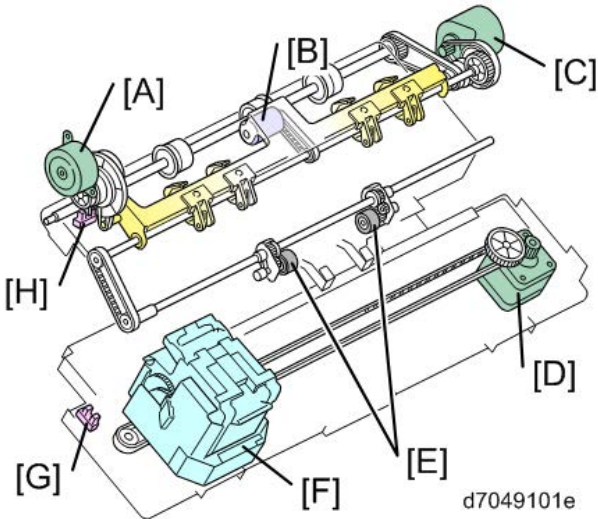

No.	Name	No.	Name
A	Positioning Roller Lift Motor	E	Drag Roller
B	Positioning Roller	F	Stapler
C	Exit Motor	G	Stapler HP Sensor
D	Stapler Movement Motor	H	Positioning Roller HP Sensor

2.Detailed Descriptions

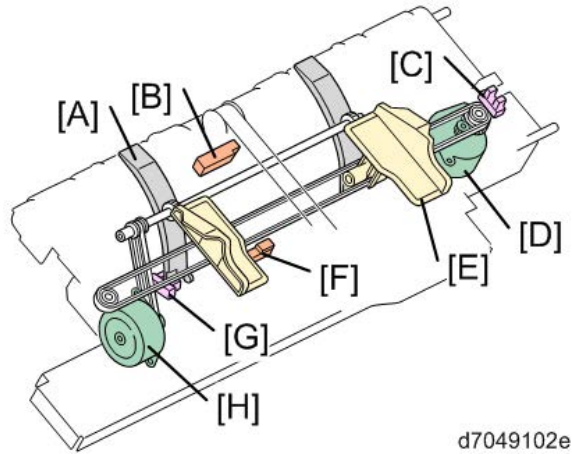

No.	Name	No.	Name
A	Edge Guide	E	Jogger Fence
B	Upper Tray Exit Sensor	F	Staple Tray Paper Sensor
C	Jogger HP Sensor	G	Edge Guide HP Sensor
D	Jogger Motor	H	Edge Guide Motor

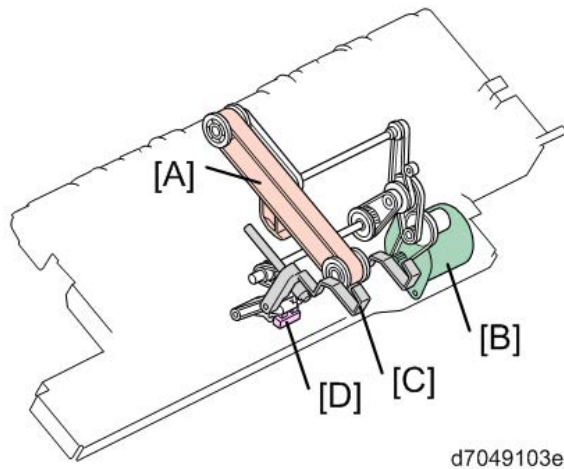

No.	Name	No.	Name
A	Stack Feed-out Belt (with stack feed-out pawl)	C	Bottom Pawl
B	Stack Feed-out Motor	D	Stack Feed-out Pawl HP

Edge Guide

When the machine applies a corner staple to a paper stack, the other end of the stack is hanging out of the exit. At this time, to prevent the paper stack from dropping to the upper tray, the edge guide [D] comes out of the unit. The edge guide operates in the following way:

1. When a job starts, the upper tray guide plate [A] shifts up.
2. The edge guide motor [B] turns on to push the edge guide [D] out. The edge guide retreats to the machine

when the last sheet of a job is output (the edge guide HP sensor [C] detects the edge guide).

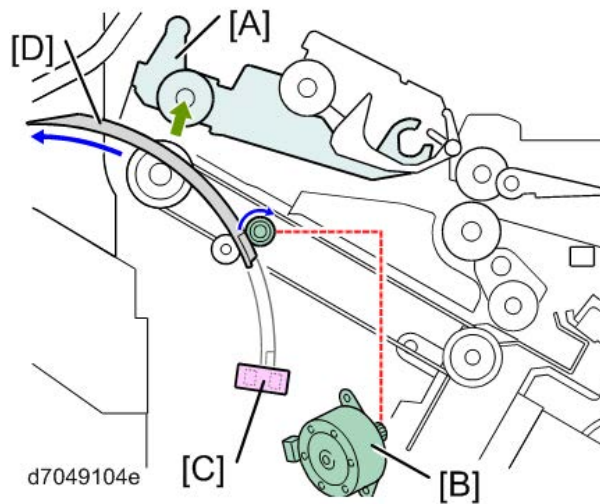

Stapler Move

The stapler movement motor [A] moves the stapler [C] along the guide rod [B]. After a job finishes, the stapler [C] returns to its HP (the stapler HP sensor [D] detects the base of the stapler).

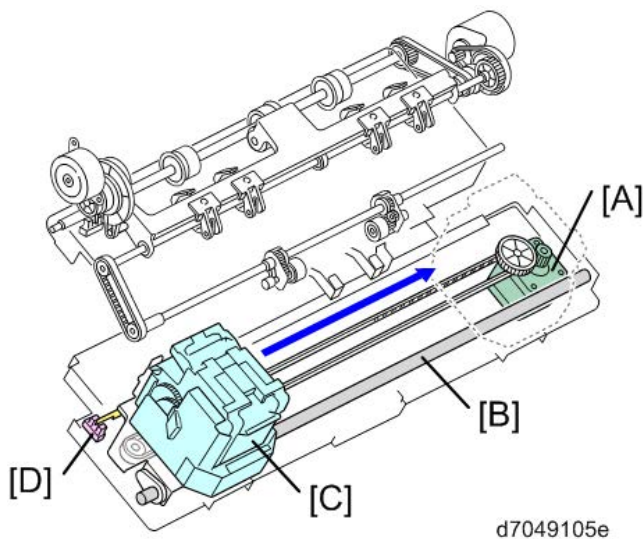

Positioning Roller / Drag Roller

The positioning roller and drag roller operate as follows:

1. The positioning roller shift motor [A] moves the positioning roller [D] down at the start of every job.
 1. The positioning roller motor [B] rotates the positioning roller [D] to feed the paper to the stapler tray.
 2. The positioning roller motor [B] also rotates the drag roller [C]. The drag roller [C] is a sponge roller

2.Detailed Descriptions

that pushes paper against the bottom pawl, in order to hold paper in the stapling position.

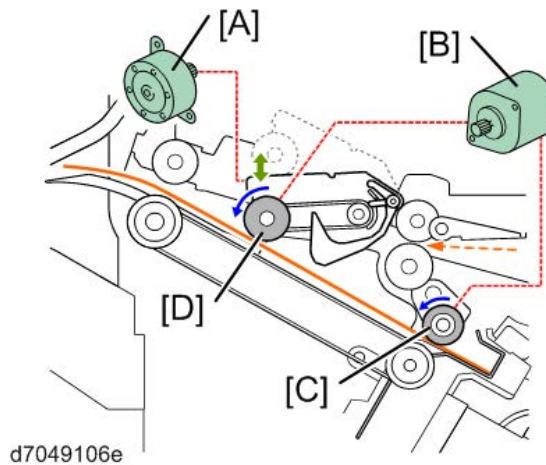

Jogger

The jogger motor [A] moves the jogger fences [C] to the ready position and waits for the first sheet. As each sheet enters, the jogger fences push toward the center. At the end of the job, the jogger fences return to their HP and stop. The jogger fence HP sensor [B] detects the jogger fence at the home position.

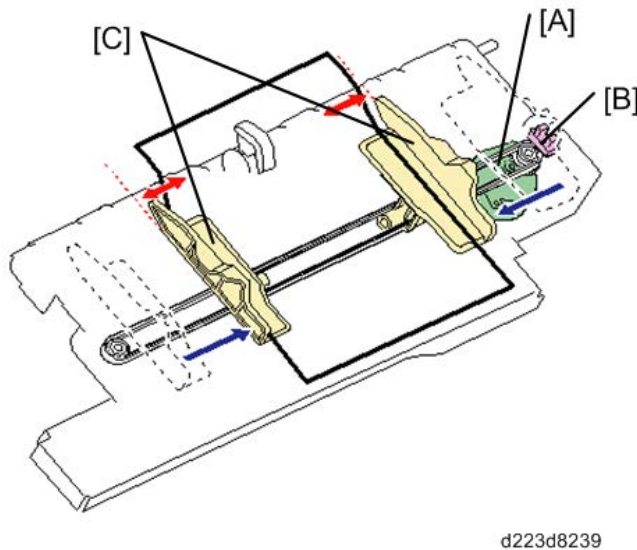

Stapler Unit

Staple firing is driven by the corner stapler motor inside the stapler unit.

When the corner stapler motor is overloaded because of a staple jam, the machine displays an error on the operation panel and stops copying.

The self priming sensor and the cartridge set sensor are inside the stapler unit.

- The self priming sensor [A]: It detects whether the staple needle is at the staple position (upper position). If the sensor is OFF, it means that the staple needle is at the lower position. Therefore, the machine feeds the staple needle to the staple position.

- The cartridge set sensor [B]: It detects the cartridge at the correct position. It also detects the staple end condition. (If the sensor is OFF, the "Add Staple" icon is displayed on the operation panel)

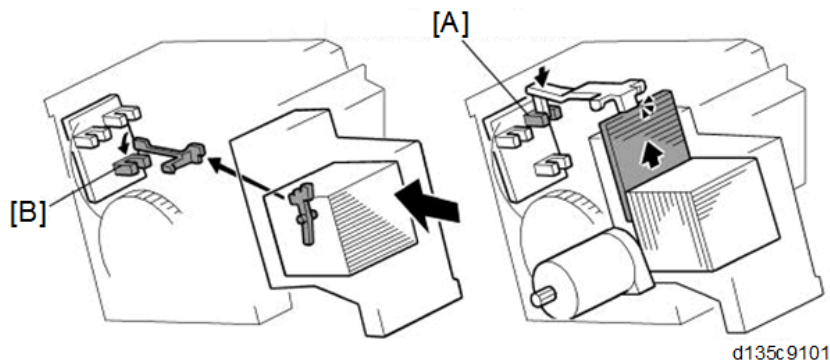

If staple end is detected during copying, the "Add Staple" icon is displayed on the operation panel after the end of the job.

Stapling

The staple hammer motor [B] lets the staple hammer [A] down in order to staple the paper stack. There are three stapling methods:

- **Oblique stapling:** [1]
- **Horizontal stapling (one position):** [2]
- **Horizontal stapling (two positions):** [3]

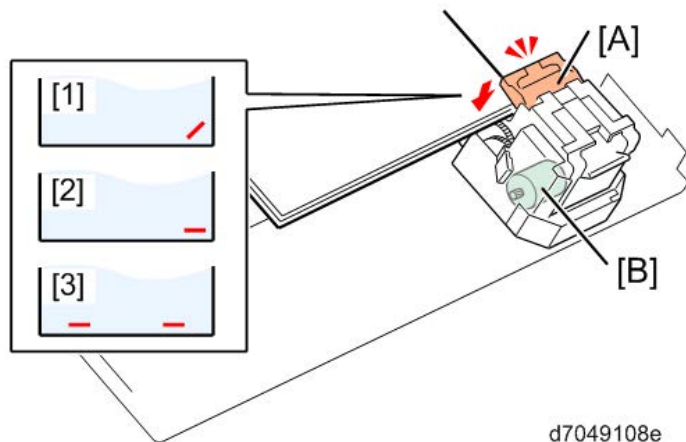

Feeding-out

The bottom pawl [B] moves the stapled paper stack up to the proper position to output. Then the stack feed-out pawl [A] that is attached to the stack feed-out belt [C] pushes the paper out. The stack feed-out motor [D] moves the stack feed-out pawl [A] and the bottom pawl [B]. After a stack has been output, both of the pawls [A] [B] return to their HP.

There are two types of stack output.

1. Pawl, exit roller: Small sizes (A4, LT, B4 SEF)

2.Detailed Descriptions

Output is performed by the exit roller as described in the output operation described above.

2. Roller exit: A4, LT, B5 LEF

Only the exit roller is used to perform output without using the mobile fence and output pawls.

Large Sizes (A3, B4, LG, DLT)

1 to 10 documents: Roller output method

More than 11 documents: Pawl, roller output method

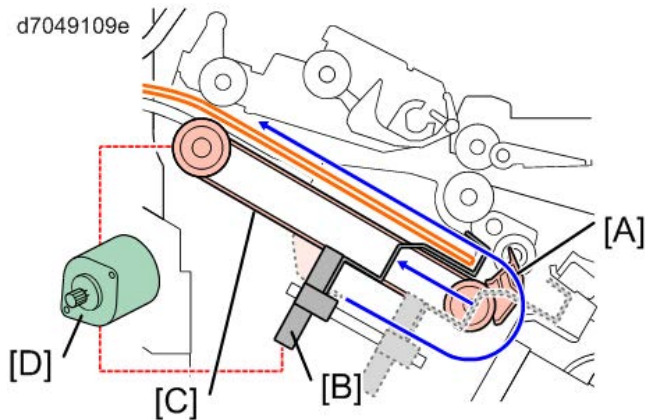

Saddle Stapling (Booklet Stapling)

What is Saddle Stapling?

Compared to normal center stapling, center stapling with this finisher can reduce the bulge at the center of the booklet.

[A] Common saddle stapling

[B] Saddle stapling with this finisher

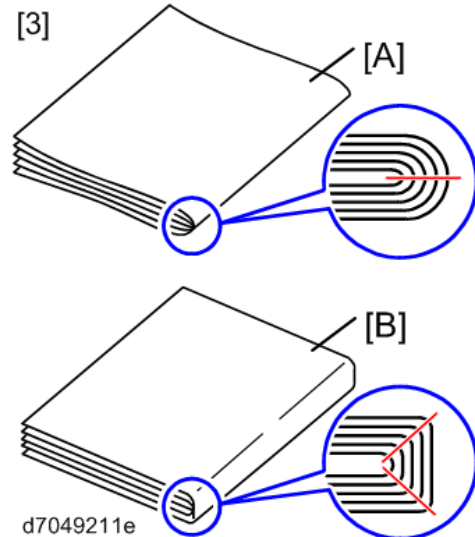

Saddle Stapling with This Finisher

Until now very heavy pressure needed to be applied in order to shape the saddle, and this could not be done unless

the finisher was very large. This finisher, however, in spite of being very small, uses the device described below to achieve a better saddle shape.

- Pressure is applied to the fold with a roller to form the saddle.
- Pressure is applied while the paper is buckled at the top and bottom with two rollers to form the saddle. The rollers move front and back to strengthen the crease with two, not just one fold.

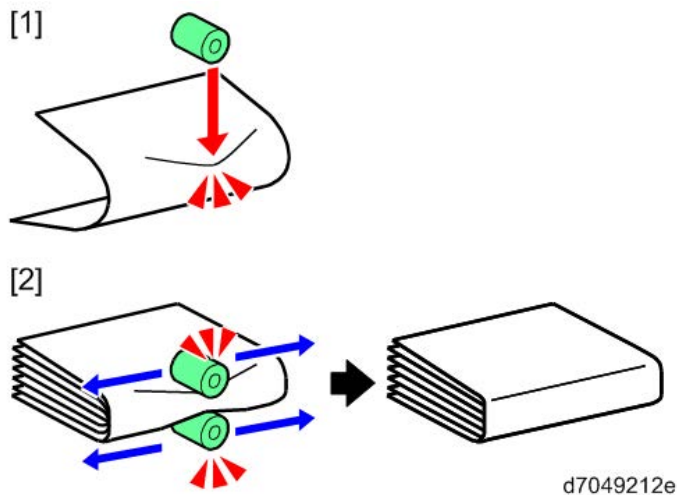

Components

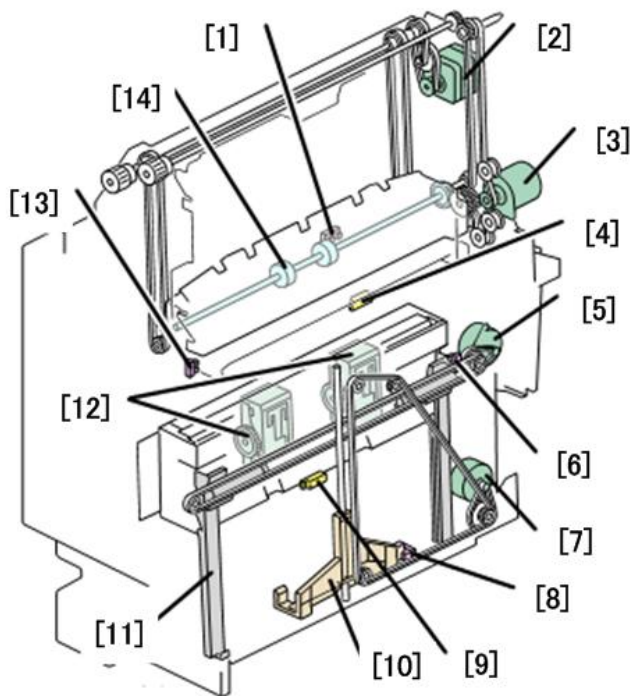

d223d8217

No.	Name	No.	Name
1	Stack Junction Gate HP Sensor	8	Bottom Fence HP Sensor
2	Shift Roller Lift Motor	9	Booklet Lower Transport Path Paper Sensor

2.Detailed Descriptions

No.	Name	No.	Name
3	Shift Roller Drive Motor	10	Bottom Fence
4	Booklet Upper Transport Path Paper Sensor	11	Jogger Fence
5	Jogger Fence Motor	12	Booklet Stapler
6	Jogger Fence HP Sensor	13	Guide Open/Closed Sensor
7	Bottom Fence Motor	14	Shift Roller

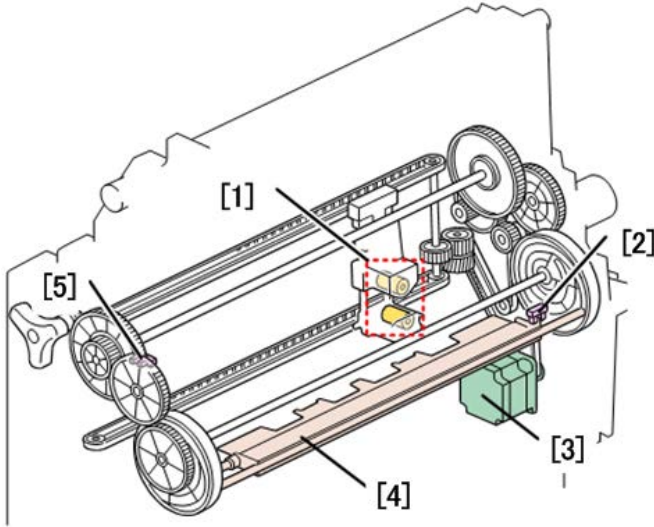

d223d8218

No.	Name	No.	Name
1	Side-to-side Shift Fold Roller	4	Fold Plate
2	Fold Plate HP Sensor	5	Fold Plate Cam Sensor
3	Fold Plate Motor		

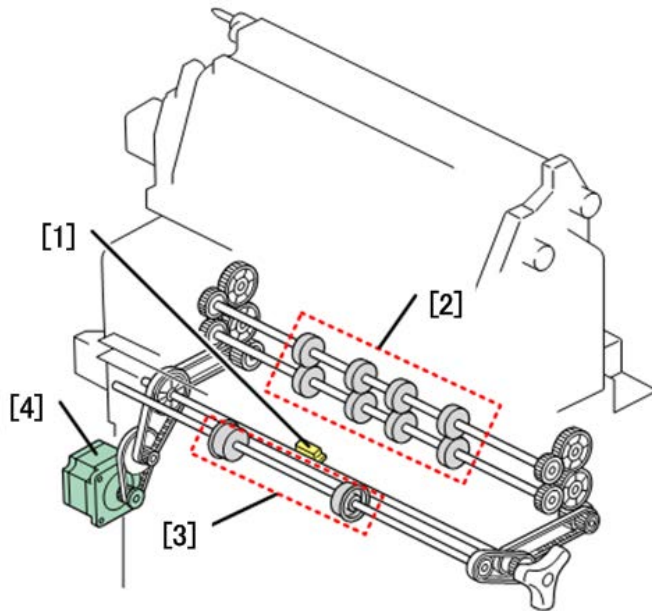

d223d8219

No.	Name	No.	Name
1	Fold Unit Exit Sensor	3	Fold Unit Exit Roller
2	Fold Roller	4	Fold Roller Motor

Booklet Staple Transport

When paper begins to go through the booklet staple path, the shift roller unit [A] moves up to its operating position in order to be ready to transport paper. The shift roller lift motor moves the shift roller unit [A]. The shift roller drive motor rotates the shift roller [B] to transport paper to the bottom.

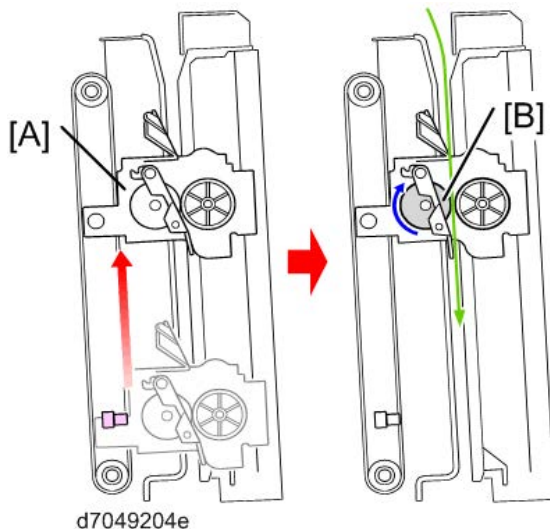

After the transportation has finished, the shift roller unit [B] moves up away from the paper face. While the shift roller unit moves up, the shift roller [A] rotates to feed paper out to the bottom. Then the shift roller unit drops to bump the stack junction gate [C] against the edge of the paper stack. This aligns the edges of the paper in the stack.

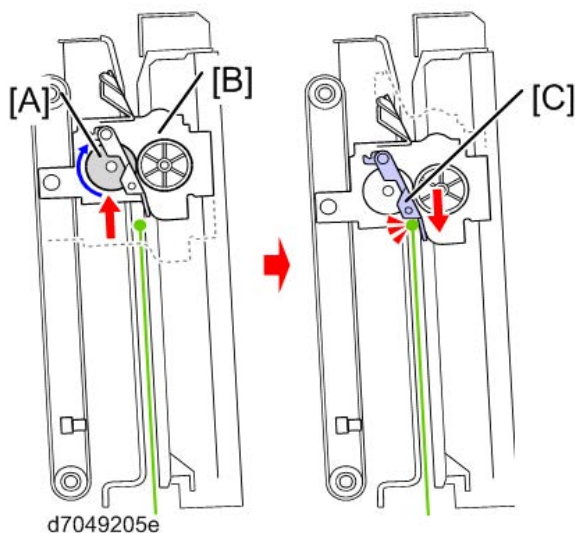

Jogger

The jogger fence motor [A] moves the jogger fences [B] in to align the sides of each page. When a job starts, the

2.Detailed Descriptions

jogger fences move to the ready position (this depends on the paper size).

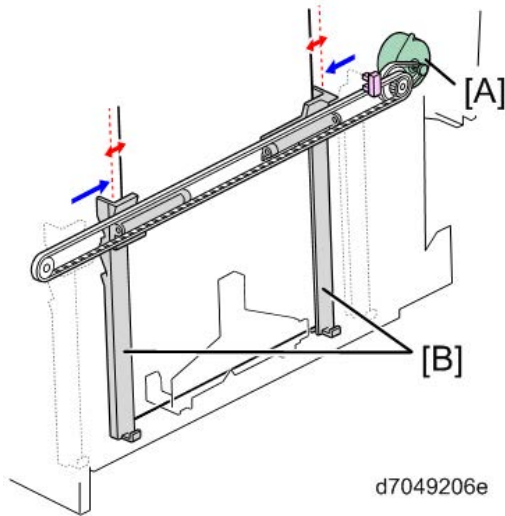

Bottom Fence Operation / Staple

Paper that is pushed with the stack junction gate bumps against the bottom fence [B] in order to align the edges of the paper in the stack. Then the booklet staplers [C] staple at the middle points of the paper stack. After that, the bottom fence motor [A] moves the bottom fence [B] up to the position where the stack is folded with the fold plate.

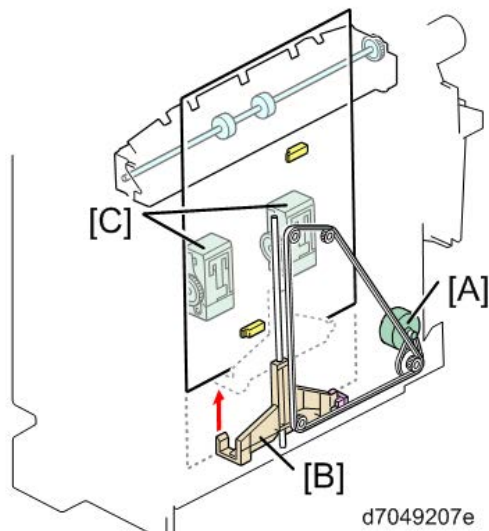

Overview of Center Folding, Saddle Shaping

Fold plate [C] center folds the stack lifted to the fold position by the bottom fence with the pressure of the fold transport motor [D]. Next, the side-to-side fold roller unit [E] forms the saddle shape. The press fold motor drives both the fold plate [C] and the side-to-side fold roller [E]. This is so that the fold plate [C] and side-to-side fold roller [E] can operate at the same time. [A] is the side-to-side fold unit HP sensor and [B] is the fold plate HP sensor.

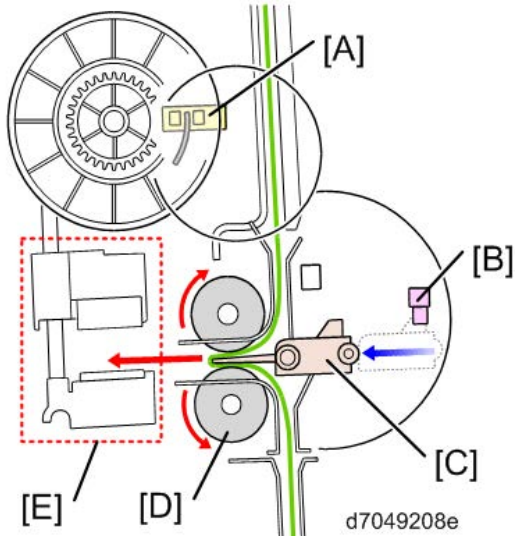

Center Folding, Saddle Shaping Operation

The operation of stack folding and saddle shaping is described below. Saddle shaping alone is described below under "Saddle Shaping Operation". When the fold plate [B] pushes the center of the stack between the fold transport rollers [E], the side-to-side roller unit [A] slides along the upper path [D]. Next, when the fold plate [B] has pushed the center of the stack completely between the fold rollers, the upper part of the fold roller unit, while pushing out switch plate 1 [F], slides down onto the lower path. Next, the lowering of the top of the side-to-side roller unit [C] presses in the center of the stack with pressure by a large spring, and then center folding begins when the fold plate [B] pushes into the center of the stack.

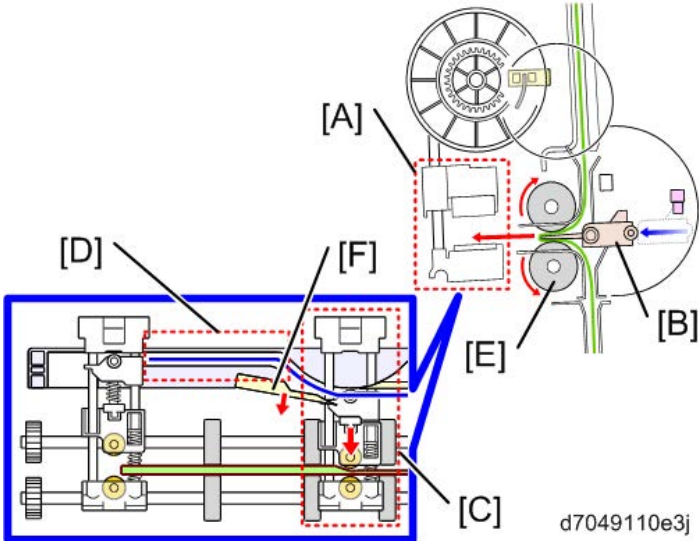

The movement of the fold plate cam stops fold plate [C] and this holds the center of the stack out in the folded position. The fold roller [B] applies pressure to the protruding stack and moves it toward the left as shown below. Next, when fold roller unit cam sensor [A] goes on twice after the cam has rotated twice, the saddle shape operation is half finished, the fold roller unit is at position [D], and then the press fold motor switches into reverse.

2.Detailed Descriptions

At the same time, in the upper path the top of fold roller unit reverses, releasing pressure on the fold.

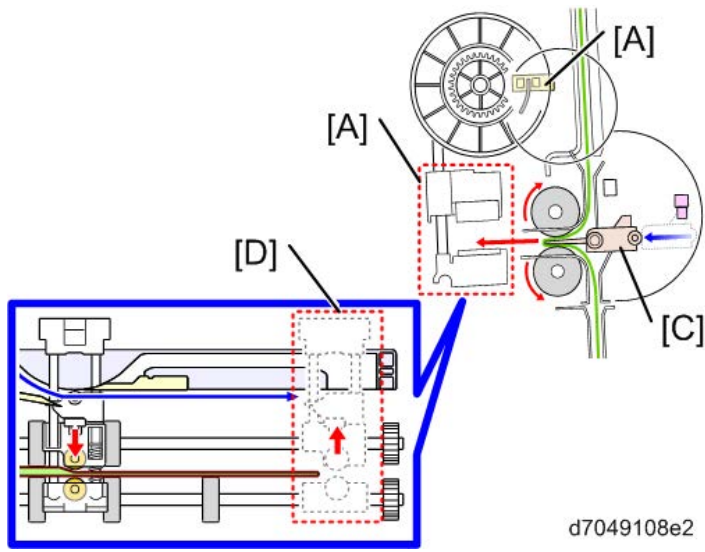

When the fold roller unit releases pressure and starts to reverse its direction, the top of the side-to-side fold roller presses switch plate 2 which directs it down into the lower path. When pressure is applied to the remaining part of the stack, fold roller [A] returns to the home position, detected by the fold blade HP sensor [B].

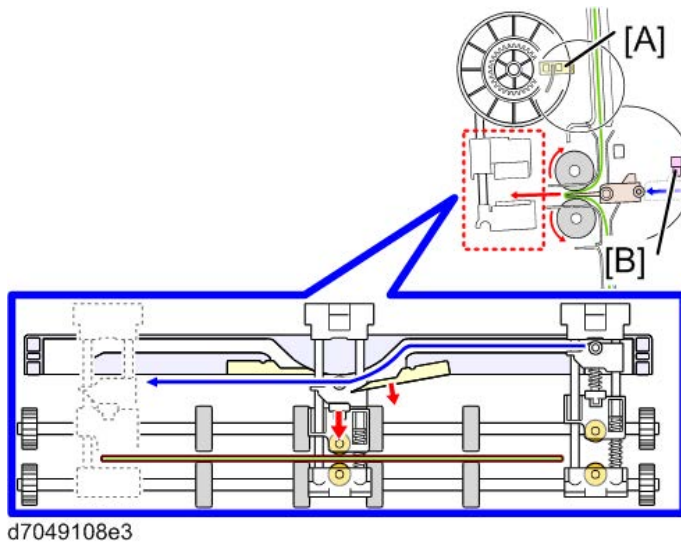

Saddle Shaping Operation

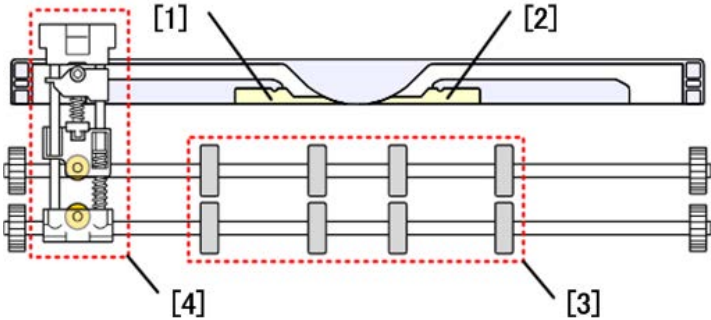

d223d8220

No.	Name	No.	Name
1	Guide Plate 1	3	Fold Transport Roller
2	Guide Plate 2	4	Side-to-Side Fold Roller Unit

The side-to-side fold roller unit in the center moves from [A] to [C]. It moves along a rail when it comes to the center, the upper fold (up) descends [B], and then pressure from a large spring folds the center of the stack. With the pressure of the side-to-side fold roller applied, the unit moves forward from [C] to [D]. When the roller moves as far as [D] the upper roller of the roller unit ascends from the lower path to the upper path, releasing the pressure on the center of the stack.

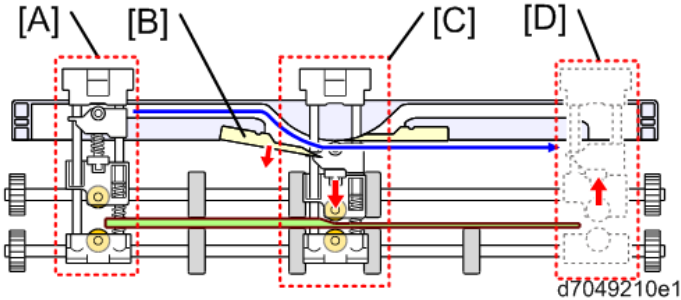

d7049210e1

The fold plate motor reverses, and the unit increases pressure on the stack as it moves and applies creasing on the remainder of the saddle shape as it moves from [C] to [A]. When the top of the side-to-side fold unit reaches the side-to-side fold unit HP sensor, the unit ascends to the upper path [B] and releases pressure on the center of the stack.

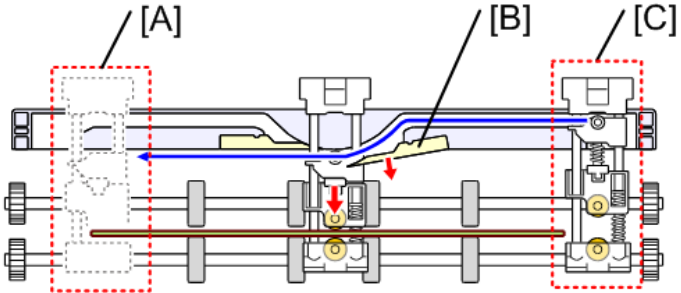

d7049210e2

2.Detailed Descriptions

Paper Guide Unit

As each stapled copy exits the finisher it contacts the copy ahead of it already on the shift tray, and the paper guide unit [A] prevents the copies from becoming entangled on the shift tray. The paper guide motor drives the paper guide cover to reduce the amount of curl and prevent the leading edges from curling and improves the output of stapled copies on the shift tray [B].

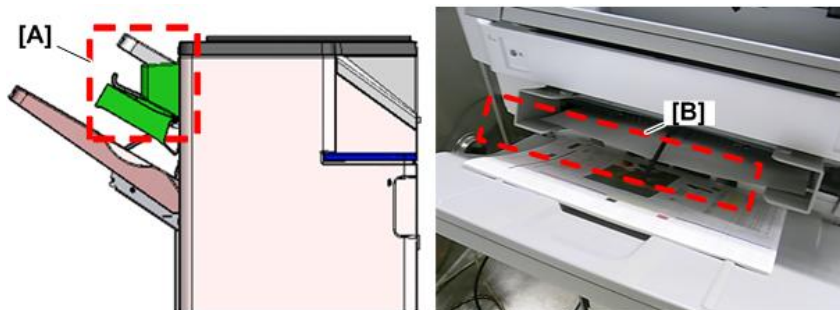

d223d8202a

Related SP Codes

The paper guide mode for corner stapled copies does not operate for shift tray exit, booklet stapled copies, large paper sizes above 300 mm.

- SP6126-001 Use Paper Guide (Small sizes up to 300 mm)
- SP6125-001 Use Paper Guide (Large sizes large than 300 mm)

Paper Guide Removal

The paper guide unit is provided with the paper guide covers [A] at the initial position for users who want to take advantage of the stacking, but these covers can be removed. (Even with the covers removed, output will be done correctly even if the paper guides touch during operation.)

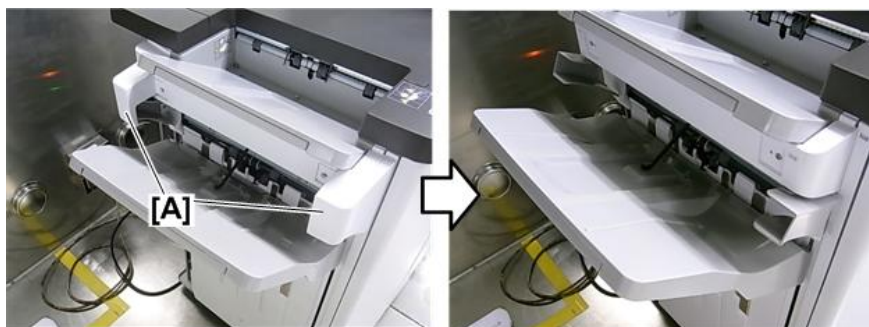

d223d8203

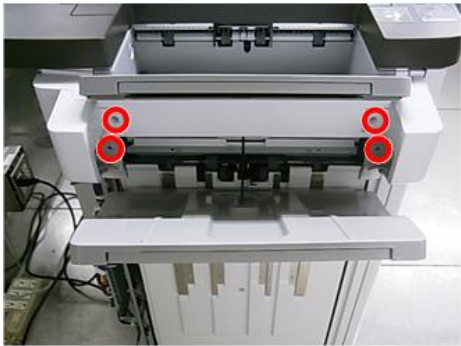

 x4

d223d8204