

Model SH-P1
Machine Code: M020/M021
Field Service Manual

29 July, 2011

Safety, Conventions

Safety

Prevention of Physical Injury

1. Before disassembling or assembling parts of the printer and peripherals, make sure that the printer power cord is unplugged.
2. The wall outlet should be near the printer and easily accessible.
3. Note that some components of the printer and the paper tray unit are supplied with electrical voltage even if the main power switch is turned off.
4. If any adjustment or operation check has to be made with exterior covers off or open while the main switch is turned on, keep hands away from electrified or mechanically driven components.
5. The inside and the metal parts of the fusing unit become extremely hot while the printer is operating. Be careful to avoid touching those components with your bare hands.
6. To prevent a fire or explosion, keep the machine away from flammable liquids, gases, and aerosols.

Health Safety Conditions

Toner and developer are non-toxic, but if you get either of them in your eyes by accident, it may cause temporary eye discomfort. Try to remove with eye drops or flush with water as first aid. If unsuccessful, get medical attention.

Observance of Electrical Safety Standards

The printer and its peripherals must be installed and maintained by a customer service representative who has completed the training course on those models.

Safety and Ecological Notes For Disposal

1. Do not incinerate toner bottles or used toner. Toner dust may ignite suddenly when exposed to an open flame.
2. Dispose of used toner, developer, and organic photoconductors in accordance with local regulations. (These are non-toxic supplies.)
3. Dispose of replaced parts in accordance with local regulations.

-
4. When keeping used lithium batteries in order to dispose of them later, do not put more than 100 batteries per sealed box. Storing larger numbers or not sealing them apart may lead to chemical reactions and heat build-up.

 CAUTION

- The controller board in this machine contains a lithium battery.
- The danger of explosion exists if a battery of this type is incorrectly replaced. Replace only with the same or an equivalent type of battery recommended by the manufacturer.
- Dispose of batteries in accordance with the manufacturer's instructions and local laws and regulations.

LASER SAFETY

The Center for Devices and Radiological Health (CDRH) prohibits the repair of laser-based optical units in the field. The optical housing unit can only be repaired in a factory or at a location with the requisite equipment. The laser subsystem is replaceable in the field by a qualified Customer Engineer. The laser chassis is not repairable in the field. Customer engineers are therefore directed to return all chassis and laser subsystems to the factory or service depot when replacement of the optical subsystem is required.

 WARNING

- Use of controls, or adjustment, or performance of procedures other than those specified in this manual may result in hazardous radiation exposure.

 WARNING

- Turn off the main switch before attempting any of the procedures in the Laser Unit section. Laser beams can seriously damage your eyes.

Caution Labels

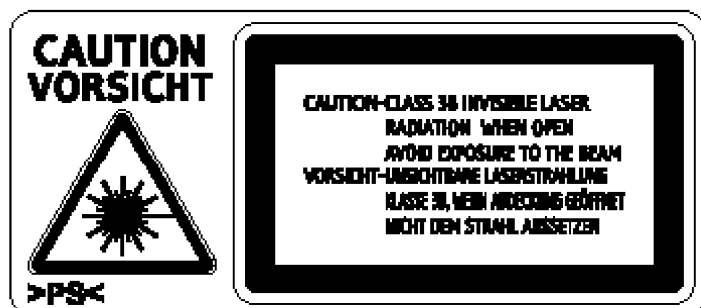

g176_labels

Conventions

Conventions

Symbol	What it means
	Refer to section number
	See Core Tech Manual for details
	Screw
	Connector
	E-ring
	C-ring

The following notations are used in text to describe the direction of paper feed: lengthwise and sideways. The annotations “SEF” and “LEF” denote “Short Edge Feed” and “Long Edge Feed”. (The arrows indicate the direction of paper feed.)

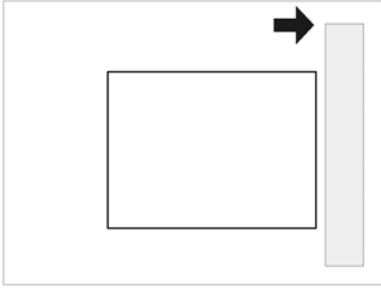

SEF (Short Edge Feed)

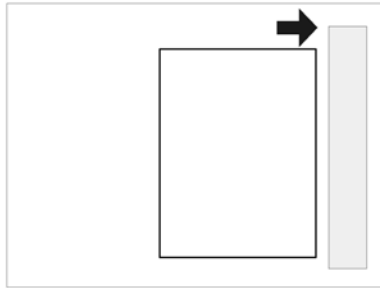

LEF (Long Edge Feed)

TABLE OF CONTENTS

Safety, Conventions.....	1
Safety.....	1
Conventions.....	3
1. Product Information	
<hr/>	
Specifications.....	11
Machine Configuration.....	12
System Components.....	12
Overview.....	15
Mechanical Component Layout	15
Drive Layout.....	16
Paper Path	17
2. Installation	
<hr/>	
Machine Installation	19
Installation Requirements.....	20
Environment.....	20
Machine Level.....	20
Minimum Operational Space Requirements.....	21
Power Supply.....	21
Controller Options.....	23
Overview.....	23
Installing the SD Memory Card Options.....	24
SD Card Application Move.....	26
IEEE 802.11 a/g (Wireless LAN).....	28
IEEE 1284 Interface Board.....	31
Gigabit Ethernet.....	33
Memory Unit Type G 256MB / I 512MB (Only for M020).....	35
Hard Disk Drive Type 2670 (Only for M020).....	37
Check All Connections.....	40
IC Card Reader (External options) Attaching Location.....	40
Paper Feed Unit TK1120 (M386).....	41
Accessory Check.....	41
Installation Procedure.....	41
When stacking four optional paper feed units.....	43

Paper Feed Unit TK1130 (M389).....	46
Accessory Check.....	46
Installation Procedure.....	46
When stacking four optional paper feed units.....	48

3. Preventive Maintenance

Maintenance Tables.....	51
User Maintenance.....	51
Service Maintenance.....	51
PM Parts Settings.....	52
Before Removing the Old PM Parts.....	52
After Installing the New PM parts.....	52
Operation Check.....	52

4. Replacement and Adjustment

General Precautions.....	53
Precautions on Disassembly	53
Releasing Plastic Latches.....	54
After servicing the machine.....	54
Covers.....	56
Right Cover.....	56
Left Cover.....	57
Upper Cover.....	58
Front Cover.....	59
Rear Cover.....	61
Operation Panel.....	62
Laser Unit.....	64
Caution Decal Locations.....	64
Laser Unit.....	64
Polygon Mirror Motor	66
Laser Synchronization Detector.....	67
Transfer Roller.....	69
Fusing.....	70
Fusing Unit.....	70
Hot Roller and Pressure Roller Sections.....	70

Fusing Lamp.....	71
Hot Roller.....	72
Fusing Thermistor.....	73
Thermostats.....	74
Pressure Roller.....	74
Fusing Cleaning Roller.....	75
Paper Feed.....	77
Paper Feed Roller.....	77
Friction Pad.....	77
Paper End Sensor.....	79
Remaining Paper Sensors 1 and 2.....	81
Registration Sensor.....	83
By-pass Tray.....	85
By-pass Tray unit.....	85
By-pass Feed Roller.....	85
By-pass Friction Pad.....	87
By-pass Paper Sensor.....	88
Duplex.....	89
Duplex Unit.....	89
Duplex Entrance Sensor.....	89
Duplex Relay Sensor.....	90
Paper Exit.....	93
Paper Overflow Sensor.....	93
Paper Exit Sensor.....	93
Electrical Components.....	96
Controller Board.....	96
Controller Box.....	97
PSU and PSU cover.....	98
Engine Board.....	100
Engine Board Bracket.....	102
Engine Board with Bracket.....	103
RFID (Radio Frequency ID).....	105
HVPS (High Voltage Power Supply).....	105

Operation Panel unit.....	105
NVRAM and EEPROM.....	109
Switches.....	112
Tray Set Switch and Paper Size detection Sensor Board.....	112
Rear-left Interlock switch.....	112
Rear-right Interlock Switch.....	113
Front Interlock Switch.....	114
Clutches.....	115
Overview.....	115
Registration Clutch.....	115
Relay Clutch.....	116
By-pass Feed Clutch.....	116
Paper Feed Clutch.....	117
Fans.....	118
Overview.....	118
AIO Fan.....	118
Exhaust Fan.....	119
PSU Fan.....	119
Transfer Thermistor.....	120
Other Electrical Components.....	121
HDD (option for M020).....	121
DIMM (option for M020).....	121
Duplex Junction Solenoid.....	122
Toner End Sensor.....	123
Drive Section.....	125
Overview.....	125
Main Motor Gear Assy.....	125
Main Motor.....	126
Paper Exit Motor.....	128
Duplex motor.....	129

5. System Maintenance Reference

Printer Service Mode.....	131
SP1-XXX (Service Mode).....	131

Engine Service Mode.....	138
Engine Mode Table.....	138
Firmware Update.....	228
Type of Firmware.....	228
Precautions.....	228
Machine Firmware Update.....	229
NVRAM Data Upload/Download.....	231
Uploading NVRAM Data.....	231
Downloading NVRAM Data.....	232
SD Card Application Move.....	234
Overview.....	234
Move Exec.....	234
Undo Exec.....	235
Menu Mode.....	237
Controller Board DIP Switches.....	240
Card Save Function.....	241
Overview.....	241
Procedure.....	241
6. Troubleshooting	
Service Call Conditions.....	245
Summary.....	245
SC Code Descriptions.....	246
Error Messages.....	270
Common error messages.....	270
Jam Detection.....	275
Paper Jam Display.....	275
Paper Jam Sensors.....	275
Jam Codes and Display Codes.....	276
Initial Jam Relations.....	278
General Troubleshooting.....	279
Image Adjustment.....	279
Skew Adjustment.....	279
Streaks in the Sub Scan Direction.....	280

7. Energy Saving

Energy Save.....	281
Energy Saver Modes.....	281
Energy Save Effectiveness.....	282
Paper Save.....	284
Effectiveness of Duplex/Combine Function.....	284
INDEX	287

1. Product Information

Specifications

1

See Appendices:

- Appendices: Basic Specifications
- Appendices: Controller Specifications

Machine Configuration

1

System Components

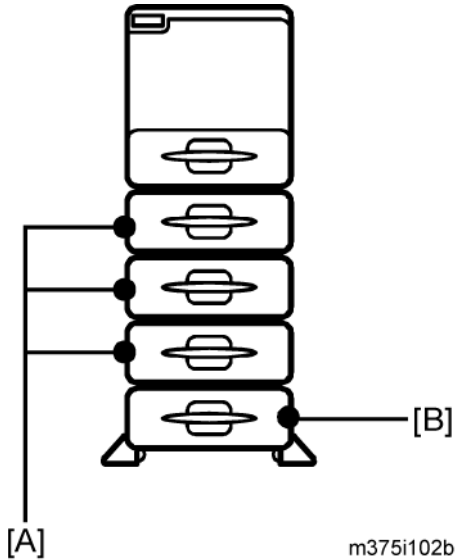

Main

Item	Machine code	Remarks
Mainframe (45 / 47 ppm)	M020	45 ppm (A4 - SEF) 47 ppm (LT - SEF)
Mainframe (50 / 52 ppm)	M021	50 ppm (A4 - SEF) 52 ppm (LT - SEF)

Options

Item	Machine code	Remarks
Paper Feed Unit TK1120 [A]	M386	Without casters
Paper Feed Unit TK1130 [B]	M389	With casters

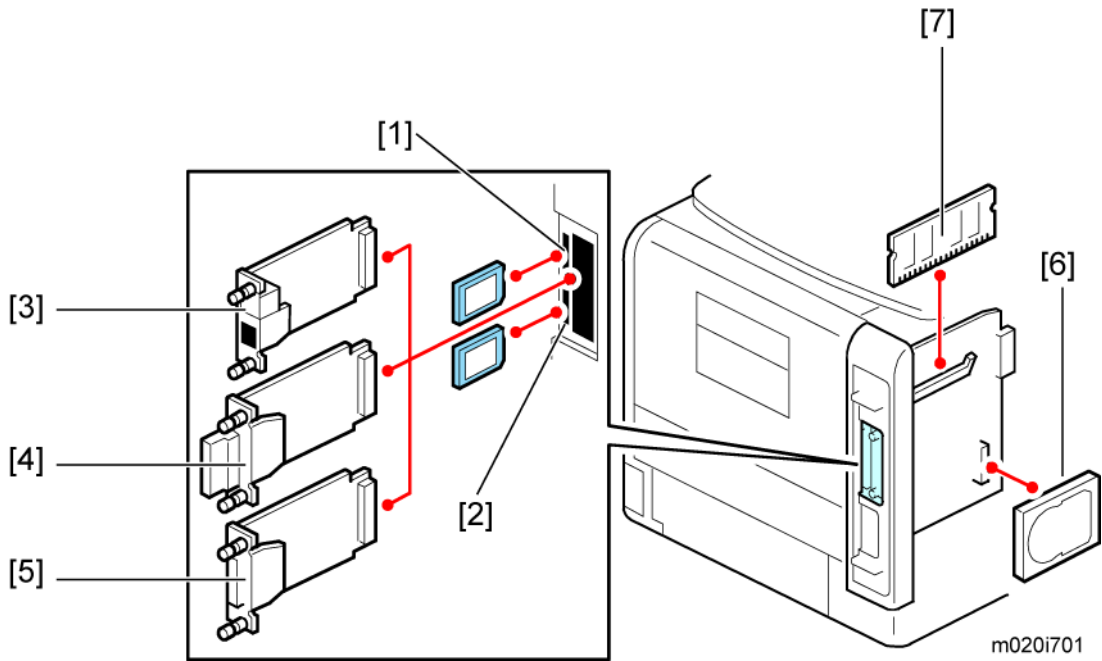

Internal options

Item	Machine code	Remarks
Memory Unit Type G 256 MB [7]	D362	Optional for M020
Memory Unit Type I 512 MB [7]	D435	Optional for M020
Hard Disk Drive Type 4310 [6]	M394	Optional for M020
IEEE 1284 Interface Board Type A [5]	B679	
IEEE 802.11a/g interface Unit Type L [4]	M344	For NA
IEEE 802.11a/g Interface Unit Type M [4]	M344	For EU
Gigabit Ethernet Board Type A [3]	G874	
Gigabit Ethernet Board Type C [3]	M397	For NA
SD Card for Netware Printing Type E [1]	M388-03	
IPDS Unit Type 5200 [1]	M388-04	For NA
IPDS Unit Type 5200 [1]	M388-05	For EU

1. Product Information

Item	Machine code	Remarks
SD Card for Fonts Type C [1]	M352	For EU

1

Overview

Mechanical Component Layout

1

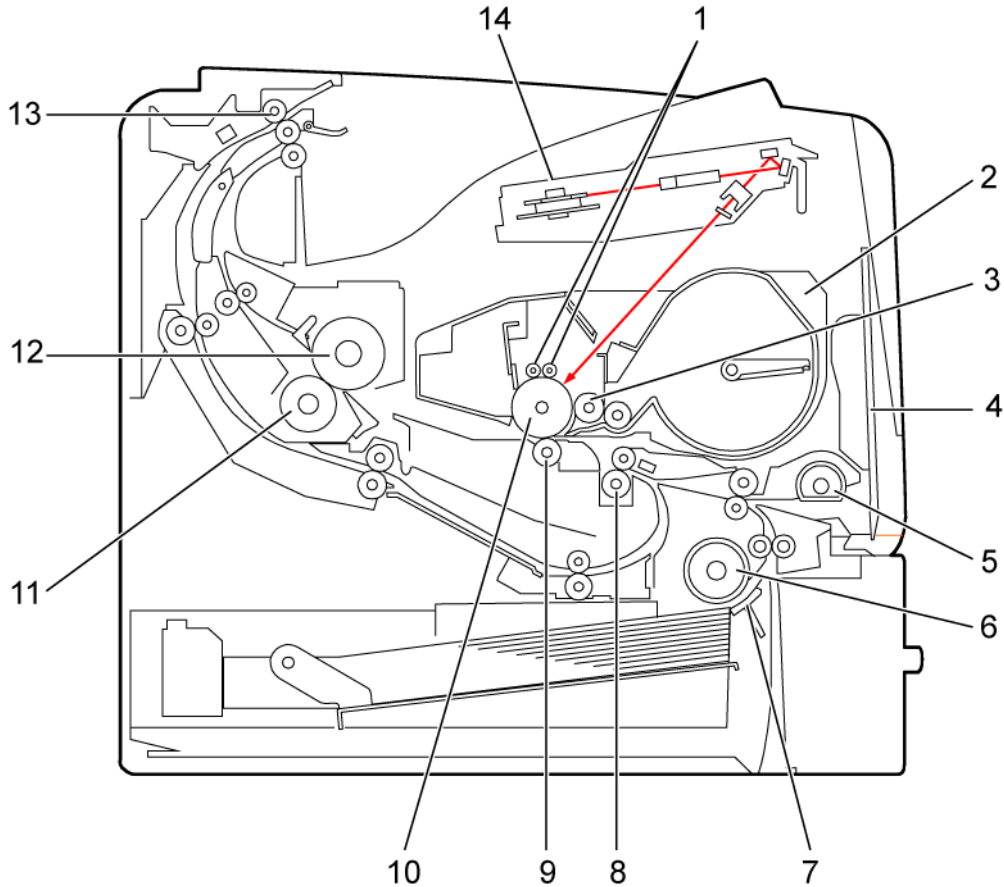

m020v101

- | | |
|-------------------------|------------------------|
| 1. Charge roller | 8. Registration roller |
| 2. Cartridge (AIO-type) | 9. Transfer roller |
| 3. Development roller | 10. Drum |
| 4. By-pass feed tray | 11. Pressure roller |
| 5. By-pass feed roller | 12. Hot roller |
| 6. Paper feed roller | 13. Paper exit roller |
| 7. Friction pad | 14. Laser unit |

Drive Layout

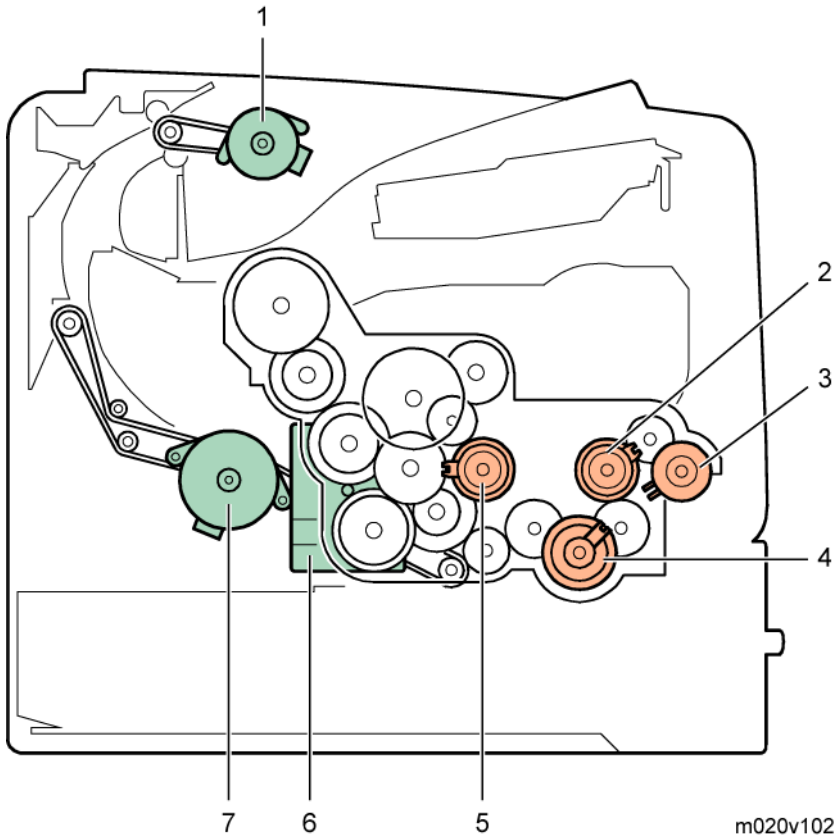

1. Paper exit motor
2. Relay clutch
3. By-pass feed clutch
4. Paper feed clutch
5. Registration clutch
6. Main motor
7. Duplex motor

Paper Path

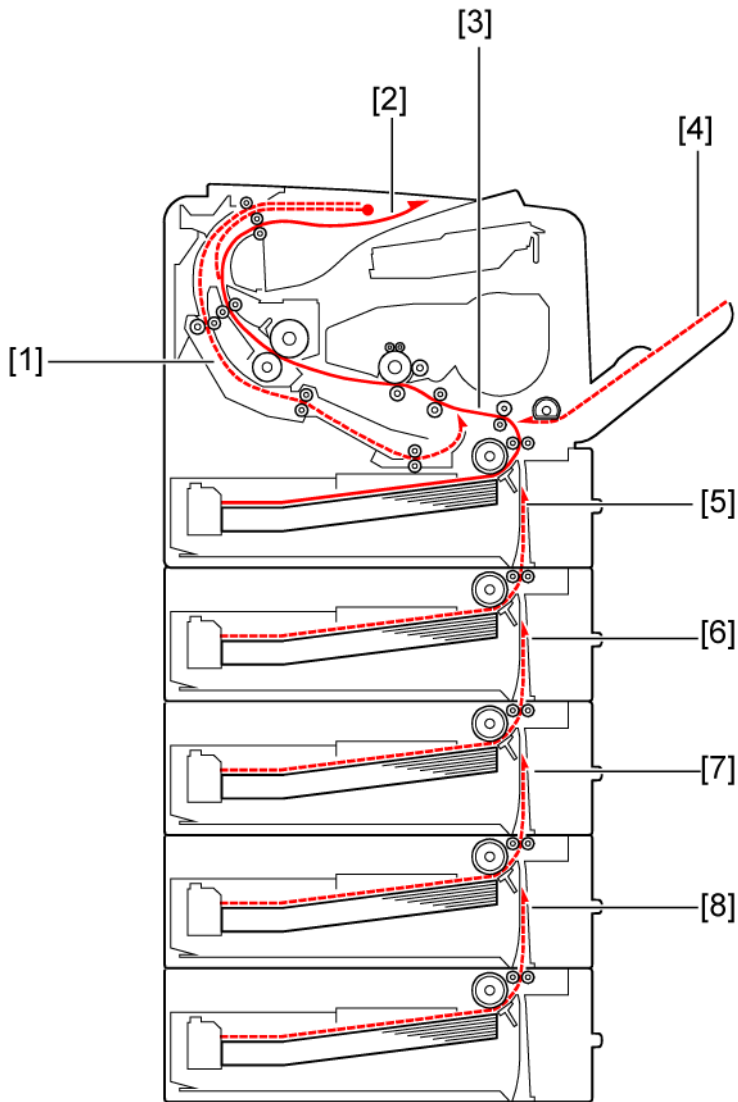

m020v201c

1. Paper feed through duplex unit
2. Paper exit to the paper stack
3. Paper feed from tray 1
4. Paper feed from by-pass tray
5. Paper feed from optional PFU (tray 2)
6. Paper feed from optional PFU (tray 3)

7. Paper feed from optional PFU (tray 4)
8. Paper feed from optional PFU (tray 5)

2. Installation

Machine Installation

Refer to the following sections for installation details for all models.

Category	Item	Machine code	References
Main unit	-	M020/ M021	Quick Installation Guide
Options	Paper Feed Unit TK1120	M386	p.41
	Paper Feed Unit TK1130	M389	p.46
	Memory Unit Type G 256 MB	D362	p.23, p.24
	Memory Unit Type I 512 MB	D435	
	Hard Disk Drive Type 4310	M394	
	IEEE 802.11a/g interface Unit Type L (NA) * 1	M344	
	IEEE 802.11a/g interface Unit Type M (EU) * 1	M344	
	IEEE 1284 Interface Board Type A	B679	
	Gigabit Ethernet Board Type A * 1	G874	
	Gigabit Ethernet Board Type C * 1	M397	
	IPDS Unit Type 5200	D571	
SD Card for Netware Printing Type E	M388-03	Software Guide, Section 6	
Drivers	-		Software Guide, Section 1

* 1: These units cannot be installed at the same time.

Installation Requirements

Environment

2

-Temperature and Humidity Chart-

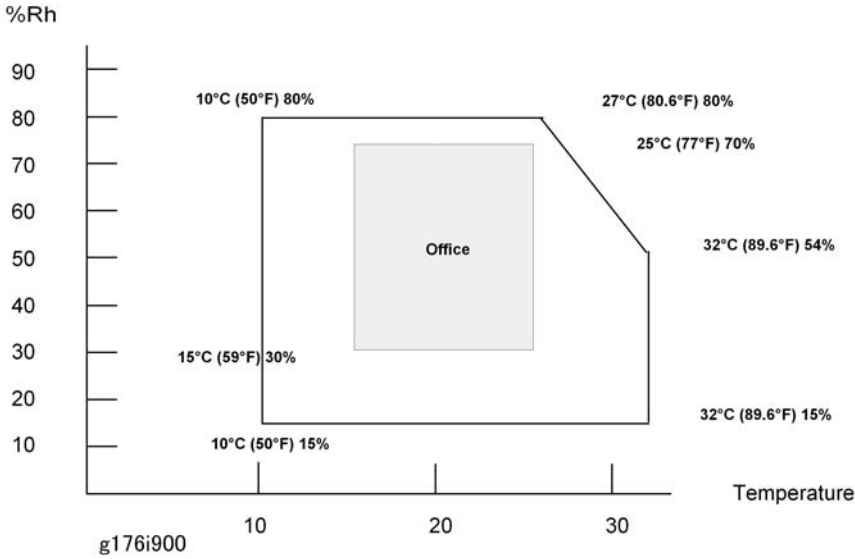

- Temperature Range: 10°C to 32°C (50°F to 89.6°F)
- Humidity Range: 15% to 80% RH
- Ambient Illumination: Less than 1,500 lux (Do not expose to direct sunlight.)
- Ventilation: Room air should turn over at least 3 times/hr/person
- Ambient Dust: Less than 0.1 mg/m³
- Do not install the machine where it will be exposed to direct sunlight or to direct airflow (from a fan, air conditioner, air cleaner, etc.).
- Do not install the machine where it will be exposed to corrosive gas.
- Install the machine at a location lower than 2,000 m (6,560 ft.) above sea level.
- Place the machine on a firm and level base.
- Do not install the machine where it may be subjected to strong vibration.

Machine Level

Front to back:	Within 5 mm (0.2") of level
----------------	-----------------------------

Right to left:	Within 5 mm (0.2") of level
----------------	-----------------------------

Minimum Operational Space Requirements

Place the machine near the power source, providing clearance as shown.

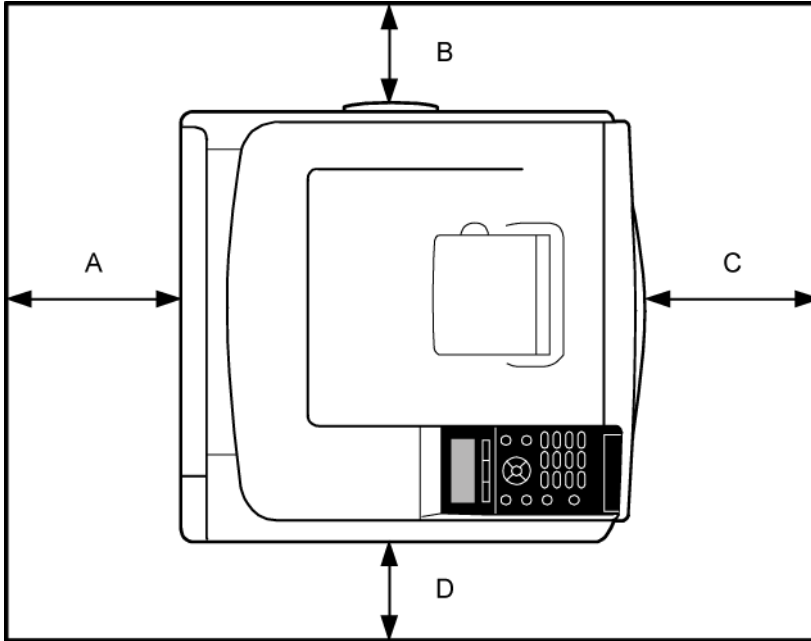

m020v261

- A: Rear – 200 mm (7.9")
- B: Right – 100 mm (4.0")
- C: Front – 350 mm (13.8")
- D: Left – 100 mm (4.0")

Power Supply

⚠ CAUTION

- Make sure that the wall outlet is near the machine and easily accessible. After completing installation, make sure the plug fits firmly into the outlet.
- Avoid multiple connections to the same power outlet.
- Be sure to ground the machine.

Input voltage:

North America:	120 – 127 V, 60 Hz, 12 A
Europe/Asia:	220 – 240 V, 50/60 Hz, 8 A

Image quality guaranteed at rated voltage $\pm 10\%$.

Operation guaranteed at rated voltage $\pm 15\%$.

Controller Options

Overview

This machine has an I/F card slot for optional I/F connections and SD card slots.

After you install an option, check that the machine can recognize it (see "Check All Connections" at the end of this section).

2

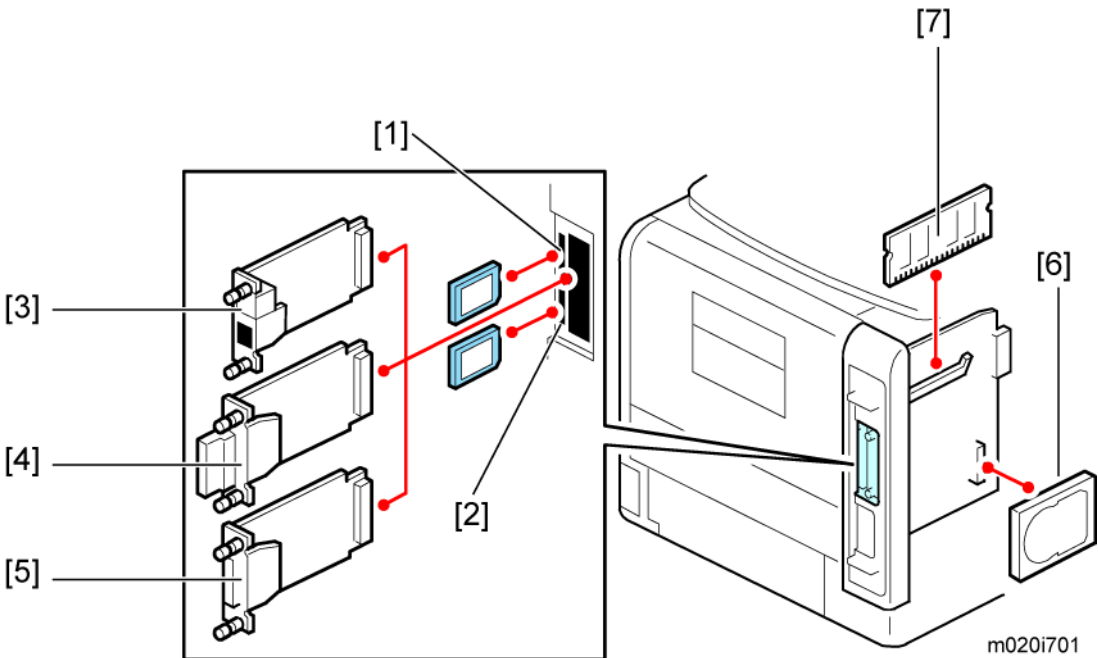

I/F Card Slots

- The I/F slot is used for one of the optional I/F connections (only one can be installed): Gigabit Ethernet [3], IEEE802.11a/g (Wireless LAN) [4] or IEEE 1284 interface board [5].

SD Card Slots

- Slot 1 [1] (Upper) is used for the Security Card (standard) and IPDS Unit.
If IPDS Unit is to be installed, first merge IPDS application into the Security Card with SP mode
- Slot 2 [2] (Lower) is used for the VM card and service (for example, updating the firmware).

SDRAM slot

- The SDRAM slot is used for the SDRAM memory [7] (Standard for type M021, optional for type M020).

Hard disk connector

- Hard disk connector is used for the hard disk [6] (Standard for type M021, optional for type M020) installation.

2

Installing the SD Memory Card Options

Installation

CAUTION

- Keep SD memory cards out of reach of children. If a child swallows an SD memory card, consult a doctor immediately.

Important

- Do not subject the card to physical shocks.
- The VM card is optional for M020 models only. To use it, the optional 512 MB SDRAM module must be installed.

1. Check the contents of the package.
2. Turn off the power, and then unplug the power cord.

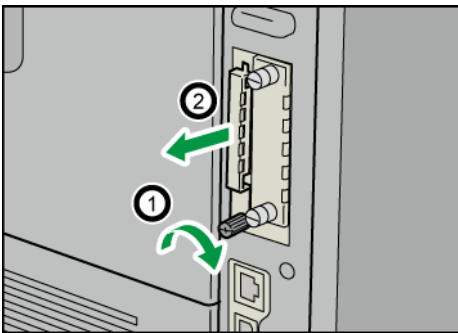

3. Remove the screw, and then carefully remove the cover of the SD card slot.

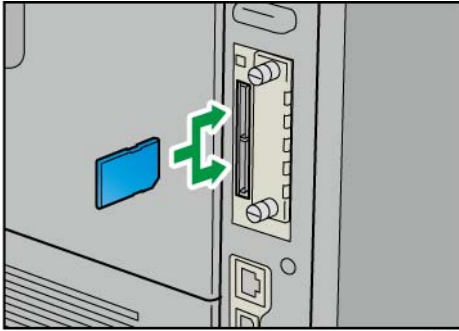

CEC070

4. Carefully push in the SD card (notched corner downward and leading), until it clicks into place.

Insert the SD card in the appropriate slot as follows:

- Upper slot: SD font card, NetWare card, Security SD card (Standard for M020), IPDS card.
- Lower slot: For service only (Firmware update, application move, etc.)

The SD card supplied with the optional hard disk (M020 model only) can be used in either of the two slots.

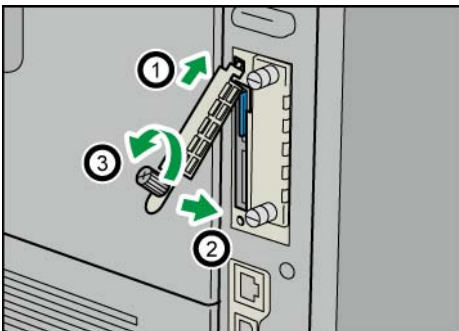

CEC069

5. Reattach the cover over the SD card. Fasten the screw to secure the cover.

↓ Note

- Do not touch the card while the printer is in use. It may come loose, even if pushed only slightly. The slot cover must be reattached.
- You can confirm that the SD card was installed correctly by checking the control panel menu. Depending on the SD card, certain menu items appear on the display.
- SD card supplied with the optional hard disk (M020 model only): Make sure [Machine Data Encryption] appears in [Security Options]. Depending on settings, [Machine Data Encryption] might not appear. For details about how to confirm this setting, consult your administrator.
- NetWare card: Make sure [NetWare] appears in [Effective Protocol] under [Network].

SD Card Application Move

★ Important

- The PostScript3 application and fonts cannot be moved to another SD card. However, other applications can be moved onto the PostScript3 SD card.

2

Overview

The service program "SD Card Appli Move" (SP5-873) lets you copy application programs from one SD card to another SD card.

Slot 1 (Upper) is used to store application programs. But there are 3 possible applications (PostScript 3, DOS (DataOverwriteSecurity) unit, PictBridge). You cannot run application programs from Slot 2 (Lower). However you can move application programs from Slot 2 (Lower) to Slot 1 (Upper) with the following procedure.

Make sure that the target SD card has enough space.

1. Enter SP5873 "SD Card Appli Move".
2. Then move the application from the SD Card in Slot 2 (Lower) to the SD Card in Slot 1 (Upper).

↓ Note

- Do steps 1 - 2 again if you want to move another application program.
3. Exit the SP mode.

Be very careful when you do the SD Card Appli Move procedure:

- The data necessary for authentication is transferred with the application program from an SD card to another SD card. Authentication fails if you try to use the SD card after you copy the application program from one card to another card.
- Do not use the SD card if it has been used before for other purposes. Normal operation is not guaranteed when such an SD card is used.
- Keep the SD card in a safe place after you copy the application program from one card to another card. This is done for the following reasons:
 - 1) The SD card can be the only proof that the user is licensed to use the application program.
 - 2) You may need to check the SD card and its data to solve a problem in the future.

Move Exec

The menu "Move Exec" (SP5873-001) lets you copy application programs from the original SD card to another SD card.

★ Important

- **Do not set ON (Lock) the write-protect switch of the system SD card or application SD card on the machine. If the write-protect switch is ON, a download error (e.g. Error Code 44) occurs during a firmware upgrade or application merge.**
1. Turn the main switch off.
 2. Make sure that an SD card is in SD Card Slot 1 (Upper). The application program is copied to this SD card.
 3. Insert the SD card with the application program in SD Card Slot 2 (Lower). The application program is copied from this SD card.
 4. Turn the main switch on.
 5. Start the SP mode.
 6. Select SP5873-001 "Move Exec."
 7. Follow the messages shown on the operation panel.
 8. Turn the main switch off.
 9. Remove the SD card from SD Card Slot 2 (Lower).
 10. Turn the main switch on.
 11. Check that the application programs run normally.

Undo Exec

"Undo Exec" (SP5873-002) lets you copy back application programs from an SD card to the original SD card. You can use this program when, for example, you have mistakenly copied some programs by using Move Exec (SP5873-001).

★ Important

- **Do not set ON (Lock) the write protect switch of the system SD card or application SD card on the machine. If the write protect switch is ON, a download error (e.g. Error Code 44) occurs during a firmware upgrade or application merge.**
1. Turn the main switch off.
 2. Insert the original SD card in SD Card Slot 2 (Lower). The application program is copied back into this card.
 3. Insert the SD card with the application program in SD Card Slot 1 (Upper). The application program is copied back from this SD card.
 4. Turn the main switch on.
 5. Start the SP mode.
 6. Select SP5873-002 "Undo Exec."
 7. Follow the messages shown on the operation panel.

8. Turn the main switch off.
9. Remove the SD card from SD Card Slot 2 (Lower).

Note

- This step assumes that the application programs in the SD card are used by the machine.

10. Turn the main switch on.
11. Check that the application programs run normally.
12. Make sure that the machine can recognize the option (see "p.40" at the end of this section).

IEEE 802.11 a/g (Wireless LAN)

Installation Procedure

⚠ CAUTION

- Unplug the main machine power cord before you do the following procedure.

You can only install one of the network interfaces or printer enhanced option at one time: IEEE 802.11 a/g (Wireless LAN), Gigabit Ethernet, or File Format Converter.

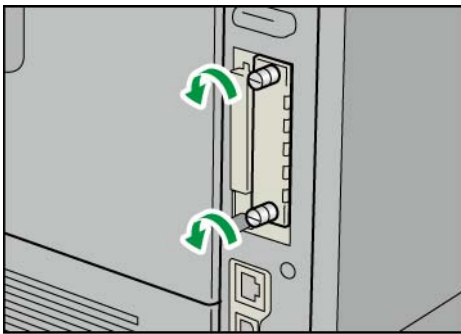

1. Remove the two screws and remove the cover of the slot in which the Wireless LAN interface board is to be installed.

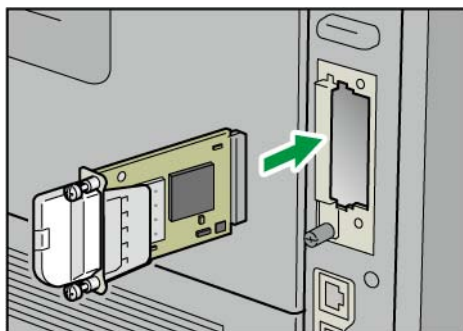

CEC065

2. Fully insert the Wireless LAN interface board.

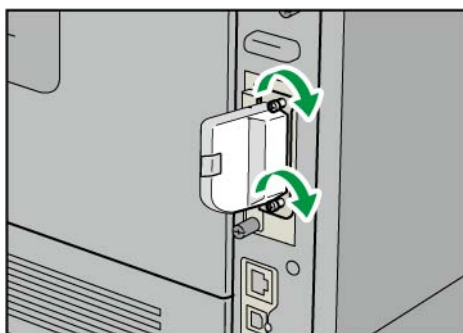

CEC242

3. Tighten the two screws to secure the interface board.

↓ **Note**

- Check the Wireless LAN interface board is connected firmly to the interface board slot.

↓ **Note**

- You may have to move the machine if the reception is not clear.
- Make sure that the machine is not located near an appliance or any type of equipment that generates strong magnetic fields.
- Put the machine as close as possible to the access point.

UP Mode Settings for Wireless LAN

Enter the UP mode. Then do the procedure below to perform the initial interface settings for IEEE 802.11 a/g. These settings take effect every time the machine is powered on.

↓ **Note**

- You cannot use the wireless LAN if you use Ethernet.
1. Press the "User Tools/Counter" key.
 2. On the touch panel, press "System Settings".

Note

- The Network I/F (default: Ethernet) must be set for either Ethernet or wireless LAN.

3. Select "Interface Settings".
4. Press "Wireless LAN". Only the wireless LAN options show.
5. Communication Mode. Select either "802.11 Ad hoc" or "Infrastructure".
6. SSID Setting. Enter the SSID setting. (The setting is case sensitive.)
7. Channel. You need this setting when Ad Hoc Mode is selected.

Region A (mainly Europe and Asia)

Range: 1-13, 36, 40, 44 and 48 channels (default: 11)

Region B (mainly North America)

Range: 1-11, 36, 40, 44 and 48 channels (default: 11)

Note

- The allowed range for the channel settings may vary for different countries.
- In some countries, only the following channels are available: Range: 1-11 channels (default: 11)

8. WEP (Encryption) Setting. The WEP (Wired Equivalent Privacy) setting is designed to protect wireless data transmission. The same WEP key is required on the receiving side in order to unlock encoded data. There are 64 bit and 128 bit WEP keys.

WEP:

Selects "Active" or "Inactive" ("Inactive" is default.).

Range of Allowed Settings:

64 bit: 10 characters

128 bit: 26 characters

9. Press "Return to Default" to initialize the wireless LAN settings.

Press "Yes" to initialize the following settings:

- Transmission mode
- Channel
- Transmission Speed
- WEP
- SSID
- WEP Key

SP Mode and UP Mode Settings for IEEE 802.11 a/g Wireless LAN

The following SP commands and UP modes can be set for IEEE 802.11 a/g.

SP No.	Name	Function
5840-006	Channel MAX	Sets the maximum range of the channel settings for the country.
5840-007	Channel MIN	Sets the minimum range of the channel settings allowed for the country.
5840-008	Transmission Speed	Sets the transmission speed. Auto , 54 Mbps, 48 Mbps, 36 Mbps, 24 Mbps, 18 Mbps, 12 Mbps, 9 Mbps, 6 Mbps, 11 Mbps, 5.5 Mbps, 2 Mbps, 1 Mbps (Default: Auto).
5840-011	WEP Key Select	Used to select the WEP key (Default: 00).
UP mode	Name	Function
	SSID	Used to confirm the current SSID setting.
	WEP Key	Used to confirm the current WEP key setting.
	WEP Mode	Used to show the maximum length of the string that can be used for the WEP Key entry.

IEEE 1284 Interface Board

CAUTION

- Unplug the main machine power cord before you do the following procedure.

Important

- Before beginning work, ground yourself by touching something metal to discharge any static electricity. Static electricity can damage the IEEE 1284 interface board.
- Do not subject the IEEE 1284 interface board to physical shocks.
- For connection to the IEEE 1284 interface board, use a half pitch 36-pin interface cable.

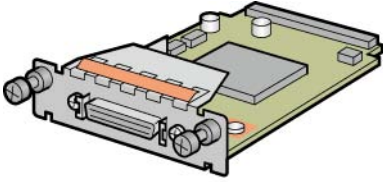

2

BFL3025

1. Check the contents of the package.

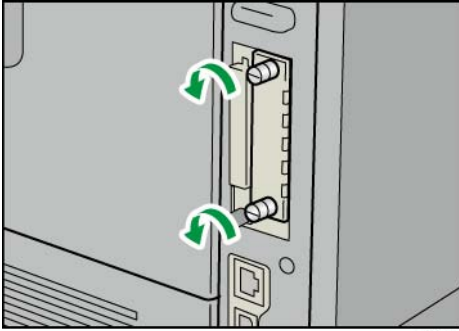

CEC061

2. Remove the two screws and remove the cover of the slot in which the 1284 interface board is installed.

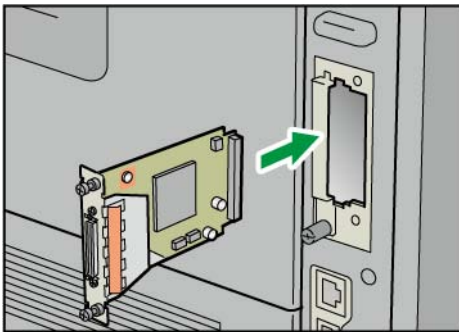

CEC066

3. Fully insert the IEEE 1284 interface board.

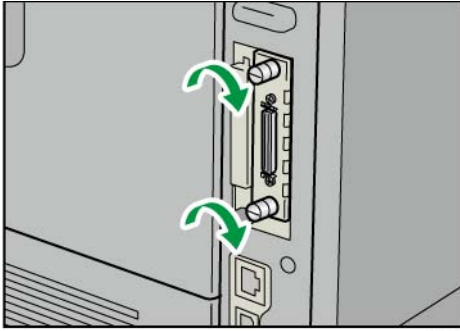

CEC060

4. Tighten the two screws to secure the interface board.

⬇ Note

- Confirm that the IEEE 1284 interface board was correctly installed by printing the configuration page. If it is correctly installed, "Parallel Interface" will appear for "Device Connection" on the configuration page.
- If the board was not installed properly, repeat the procedure from step 3.
- For details on printing the configuration, see "p.40" at the end of this section.

Gigabit Ethernet

⚠ CAUTION

- Unplug the main machine power cord before you do the following procedure.

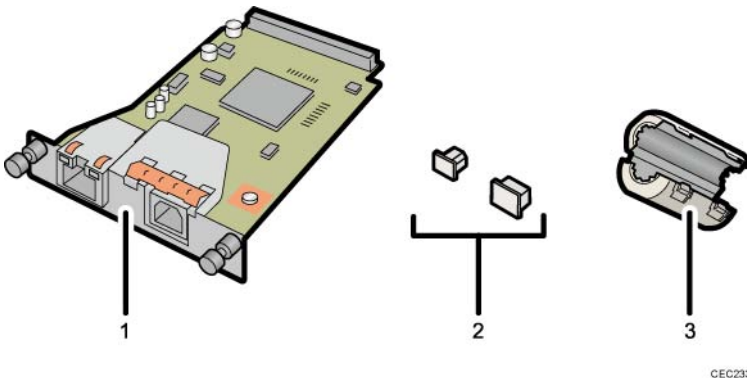

CEC233

- 1: Gigabit Ethernet Board
- 2: Protective caps (one each for the Ethernet port and the USB port)
- 3: Ferrite core (Design of the ferrite core varies according to printer model.)

1. Check the contents of the package.

2

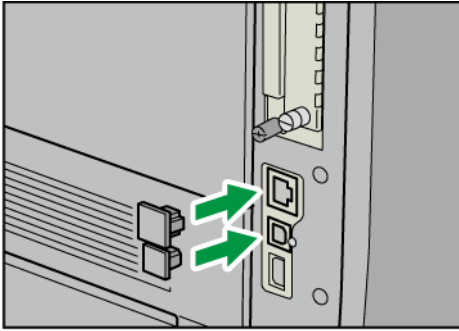

2. Disconnect the cables from the Ethernet port and USB port of the printer, and cover each port with its protective cap.

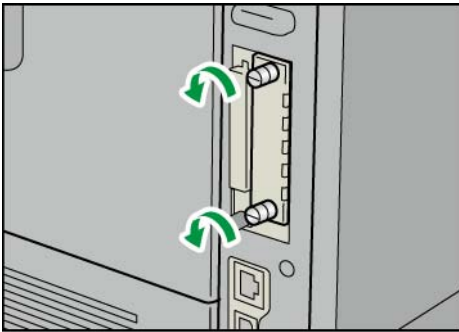

3. Remove the two screws and remove the cover of the slot in which the Gigabit Ethernet board is installed.

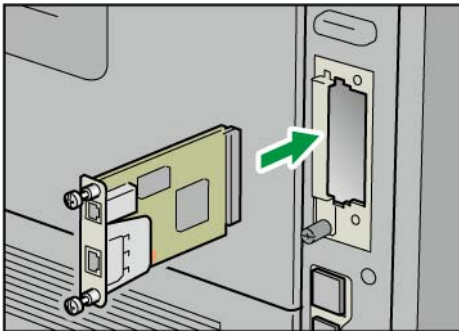

4. Fully insert the Gigabit Ethernet board.

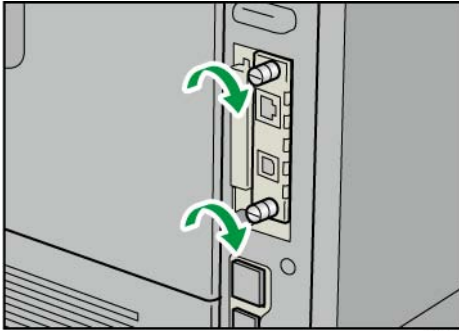

CEC069

5. Tighten the two screws to secure the Gigabit Ethernet board.

Note

- Check the Gigabit Ethernet board is connected firmly to the interface board slot.
6. Attach the ferrite core [3] to the LAN cable, and connect the LAN cable to the machine.
 7. Make sure that the machine can recognize this option (see 'p.40' at the end of this section).

Memory Unit Type G 256MB / I 512MB (Only for M020)

⚠ CAUTION

- Unplug the main machine power cord before you do the following procedure.

1. Controller unit (➡ p.96)

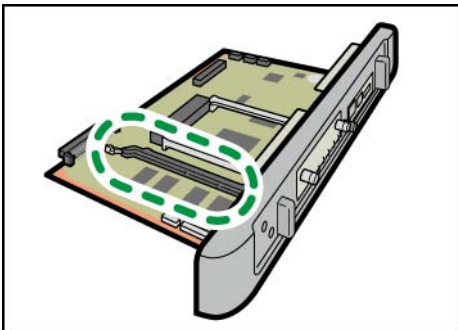

CEC012

2. Place the controller board on a flat surface. The SDRAM module is installed in the slot shown in the illustration above.

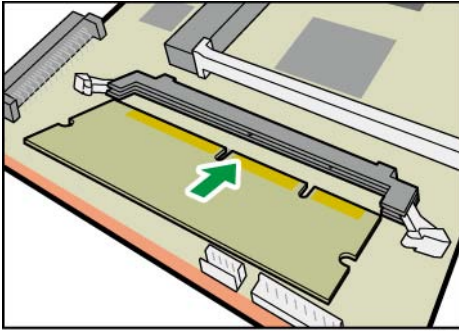

CEC013

3. To install the recommended memory, align the notch of the memory module with the protruding part of the vacant slot, and then carefully insert the module at an angle.

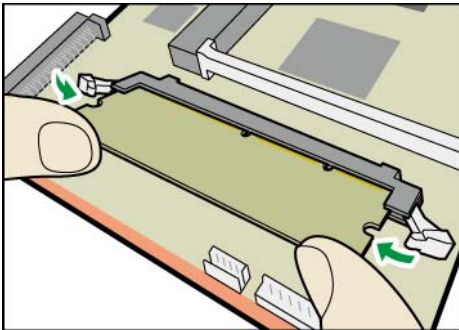

CEC014

4. Keeping the module at an angle, press it down until it clicks into place.

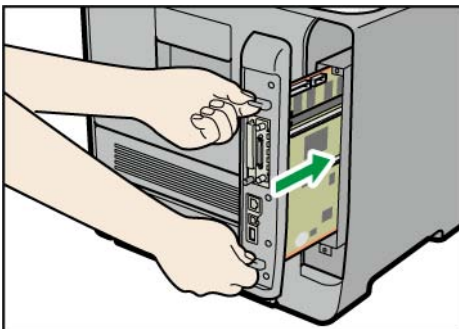

CEC076

5. Align the controller board with the top and bottom rails, and then push it carefully in, until it stops.

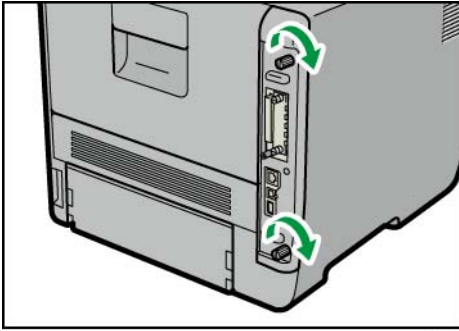

CEC072

6. Fasten the controller board to the printer with the two screws.

↓ Note

- After finishing the installation, you can check the SDRAM module is properly installed: Print the configuration page from the [List/Test Print] menu. If it is installed properly, the memory capacity will appear under "Total Memory" on the configuration page.
- The table below shows the total SDRAM module capacities.

Standard	Extended	Total
256 MB	256MB	512 MB
256 MB	512 MB	768MB

Hard Disk Drive Type 2670 (Only for M020)

⚠ CAUTION

- Unplug the main machine power cord before you do the following procedure.

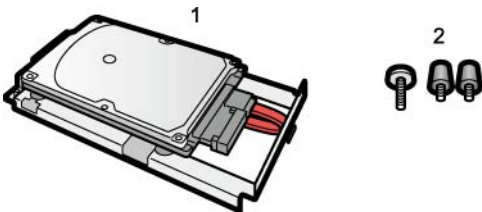

CEC015

1: Hard disk

2: Screws (Knob screws x 3)

1. Check the package contains the above.
2. Controller unit (➡ p.96)

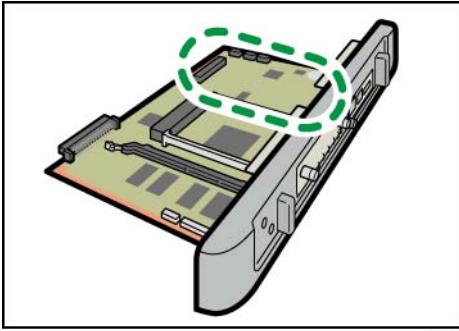

CEC019

3. Place the controller board on a flat surface. The hard disk is installed in the slot shown in the illustration above.

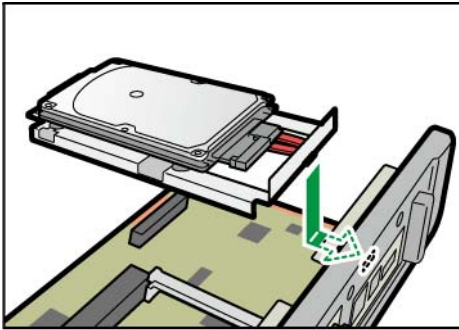

CEC016

4. Insert the protrusion on the front end of the hard disk board into the notch on the back panel of the controller board.

Note

- Be sure to set the hard disk board parallel with the controller board.

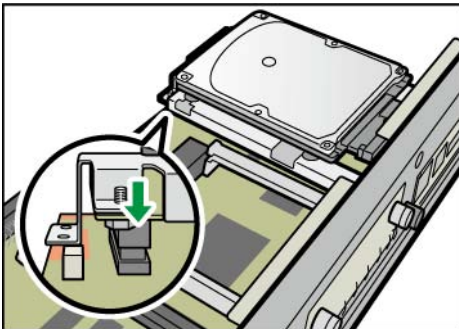

CEC017

5. Fit the hard disk on the connector of the controller board carefully until it stops.

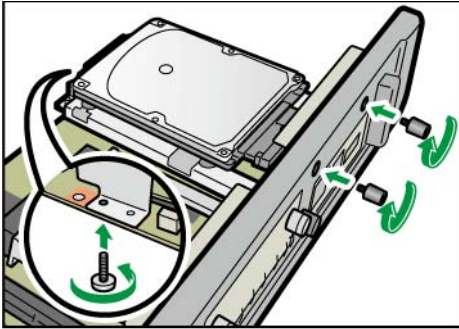

CEC018

6. Tighten the two screws by turning them clockwise with a coin, and then secure the hard disk board by tightening the third screw from the under side of the controller board.

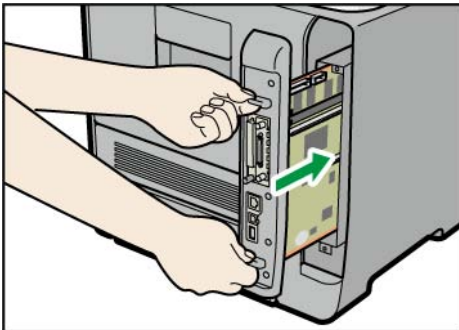

CEC076

7. Align the controller board with the top and bottom rails, and then push it carefully in, until it stops.

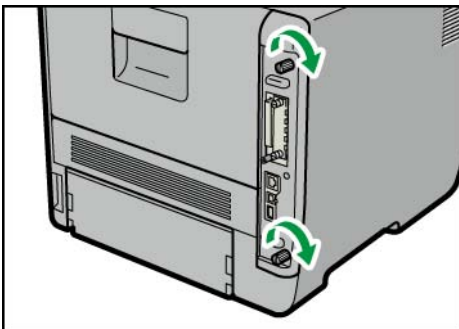

CEC072

8. Fasten the controller board to the printer with the two screws.

↓ Note

- After finishing installation, you can check whether the hard disk is properly installed: Print the configuration page from the [List/Test Print] menu. If it is installed properly, you will see "Hard Disk" will appear for "Device Connection" on the configuration page.
- If the Hard disk is not properly installed, repeat this procedure.
- For details on printing the configuration, see "p.40" at the end of this section.

Check All Connections

1. Plug in the power cord. Then turn on the main switch.
2. Enter the printer user mode. Then print the configuration page.

User Tools > Printer Settings > List Test Print > Config. Page

All installed options are shown in the "System Reference" column.

2

IC Card Reader (External options) Attaching Location

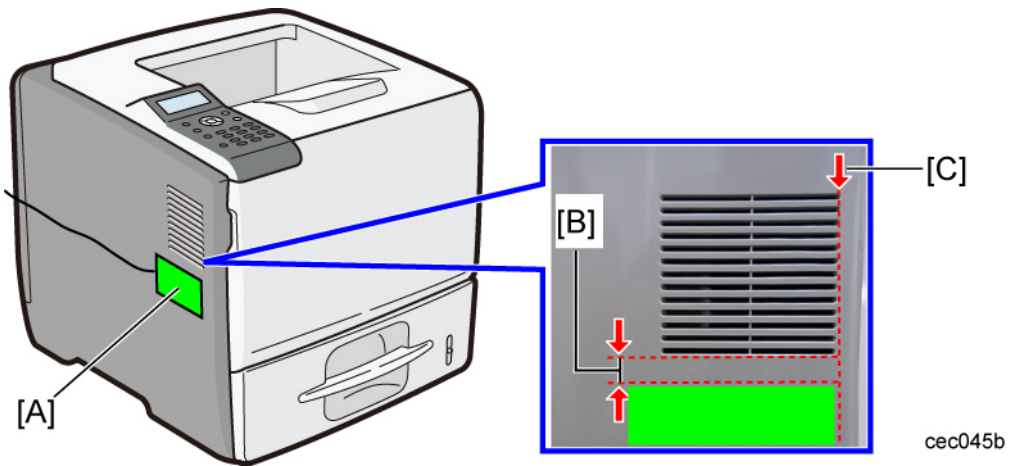

To enable good communication between the IC card reader and the IC card, install the IC card reader at the position above [A].

- Position the IC card reader with the upper edge 10 mm (0.4 in.) below the air inlet [B].
- Align the front edge of the IC card reader with the front line of the air inlet [C].

↓ Note

- The USB cable of the IC card reader should be fixed with clamps to prevent it from sagging.

Paper Feed Unit TK1120 (M386)

Accessory Check

Confirm that you have these accessories.

Description	Q'ty
Installation instructions	1
EMC sheet	1
Fixation screws	2

2

Installation Procedure

⚠ CAUTION

- Unplug the main machine's power cord before starting the following procedure.

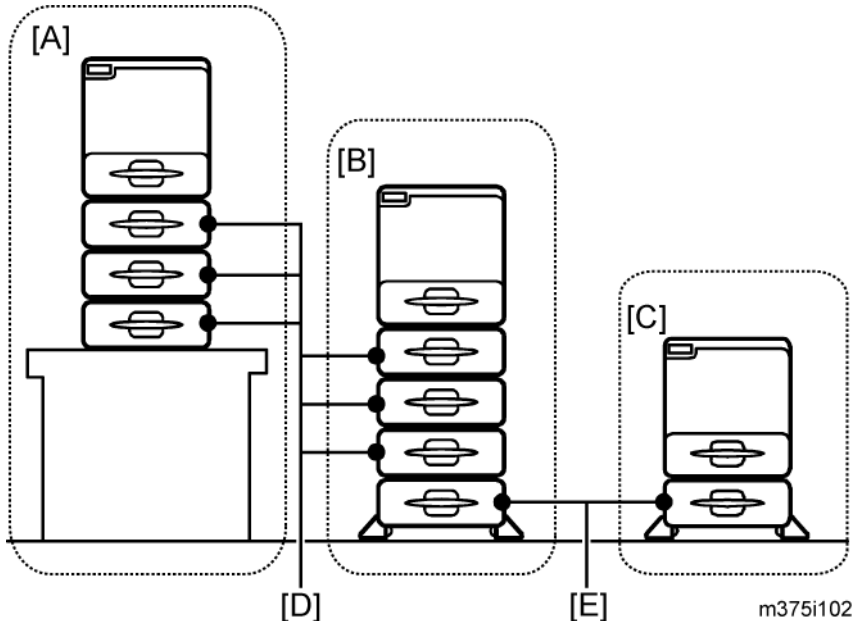

The number of optional paper feed units that can be attached depends on the location where the machine is installed.

- [A]: Up to three paper feed units (M386 [D]) can be installed on a desk.

2

- [B]: Up to three paper feed units (M386 [D]) and one paper feed unit (M389 [E]) can be installed on the floor.
- [C]: Attach the optional paper feed unit with casters (M389 [E]) to the bottom of the machine to install the machine directly on the floor.

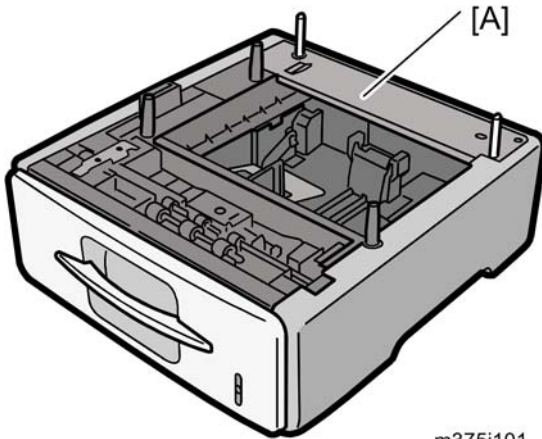

1. Remove all tape and cardboard from the optional paper feed unit [A].
2. Pull the paper tray of the main unit part way out; then, remove the tape and cardboard in the paper tray, and push the tray back in.

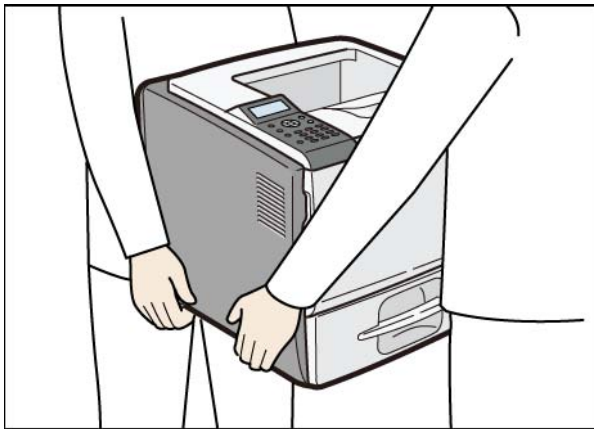

3. Lift the printer using the inset grips on both sides of the printer.

★ Important

- When moving the printer, do not hold on the following parts as doing so could cause a malfunction:
 - The handle of the standard paper tray.
 - The underside of the by-pass tray.

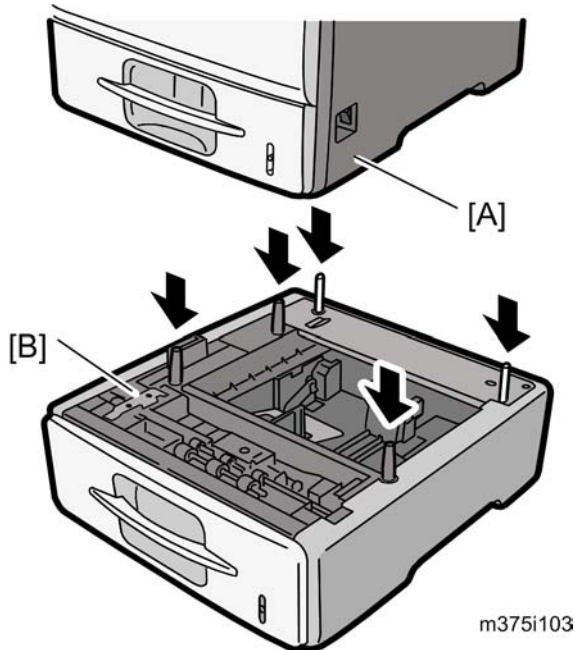

4. Set the machine [A] on the paper feed unit [B].
 - Two people are required to lift the machine.

Note

- When installing a second paper feed unit, place it on the first paper feed unit before placing the printer onto the pair of paper feed units

5. Remove the paper(s) tray from the paper tray unit(s).
6. Load paper into the paper tray(s). Adjust the side and end fences as necessary. If loading 8¹/₂"x 14" paper, remove the end fence and set it in the special compartment.
7. Insert the paper tray(s) back in the paper tray unit(s).

TK1120 RTB 2
Points to check at installation

When stacking four optional paper feed units

Paper feed units should be fixed to each other with screws when stacking four optional paper feed units. Fix the paper feed units to each other as described below.

2

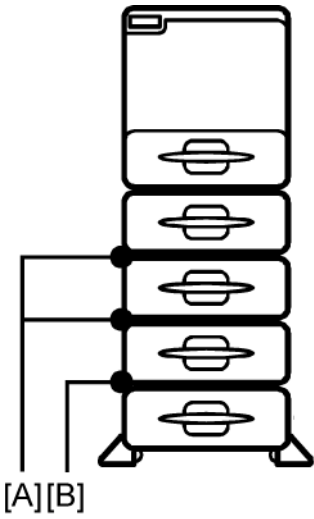

m375i102c

1. Between top three optional units [A]
2. Between the unit with casters (forth optional) and the third optional unit [B]

Fixing the units together

1. Pull out the paper trays of the paper feed units to be fixed.

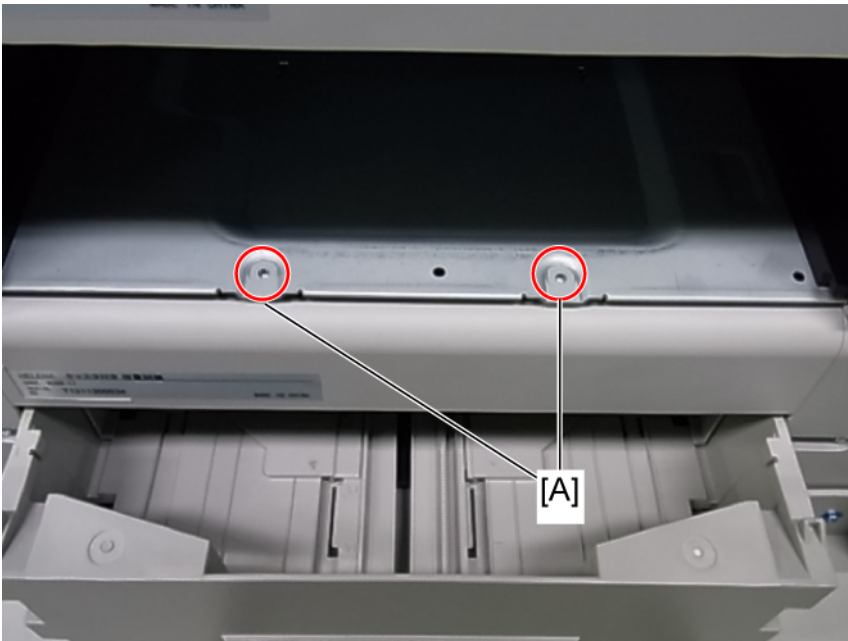

m020i003

2. Fix the paper feed unit at the rear side [A] with the two screws that come with the paper feed unit.

 **Important**

- **Never detach the stabilizers of the paper feed unit with casters (M389).**

Paper Feed Unit TK1130 (M389)

Accessory Check

Confirm that you have these accessories.

2

Description	Q'ty
Installation instructions	1
EMC sheet	1

Installation Procedure

⚠ CAUTION

- Unplug the main machine's power cord before starting the following procedure.

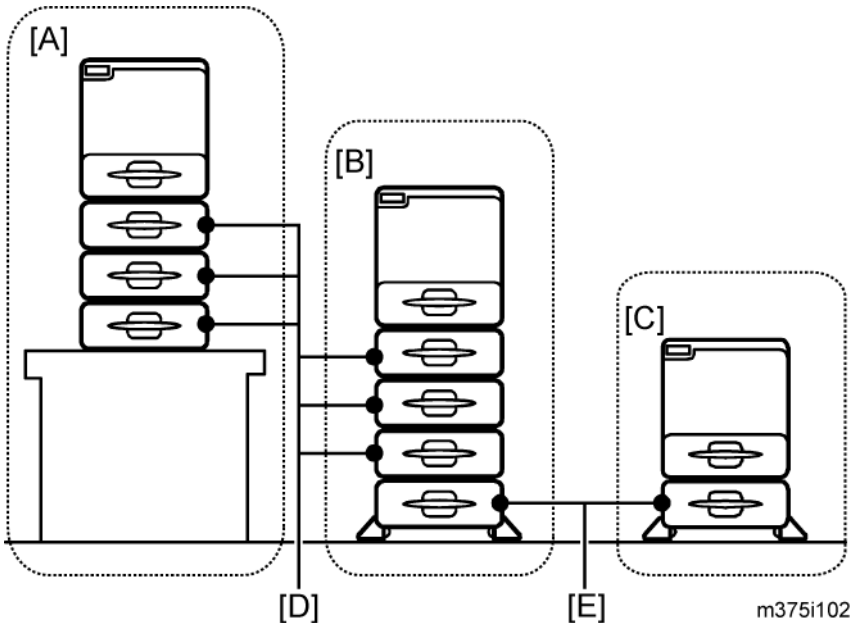

The number of optional paper feed units that can be attached depends on the location where the machine is installed.

- [A]: Up to three paper feed units (M386 [D]) can be installed on a desk.
- [B]: Up to three paper feed units (M386 [D]) and one paper feed unit (M389 [E]) can be installed on the floor.

- [C]: Attach the optional paper feed unit with casters (M389 [E]) to the bottom of the machine to install the machine directly on the floor.

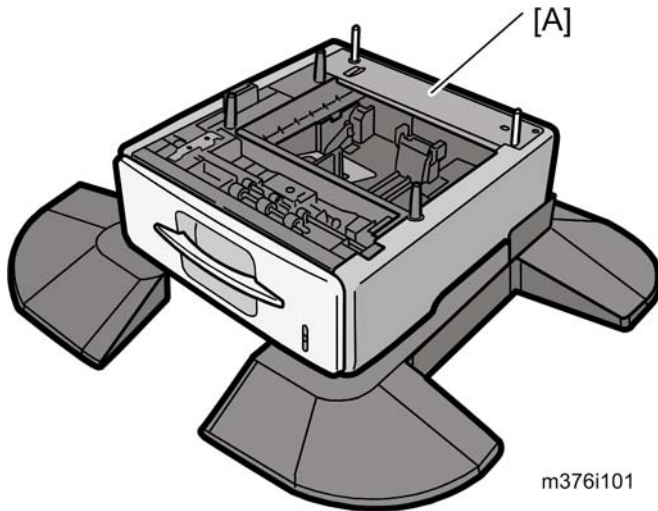

2

1. Remove all tape and cardboard from the optional paper feed unit [A].
2. Pull the paper tray of the main unit part way out; then, remove the tape and cardboard in the paper tray, and push the tray back in.

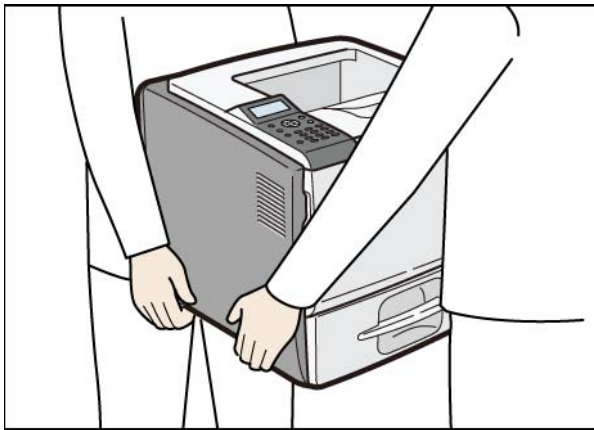

3. Lift the printer using the inset grips on both sides of the printer.

★ Important

- When moving the printer, do not hold on the following parts as doing so could cause a malfunction:
 - The handle of the standard paper tray.
 - The underside of the by-pass tray.

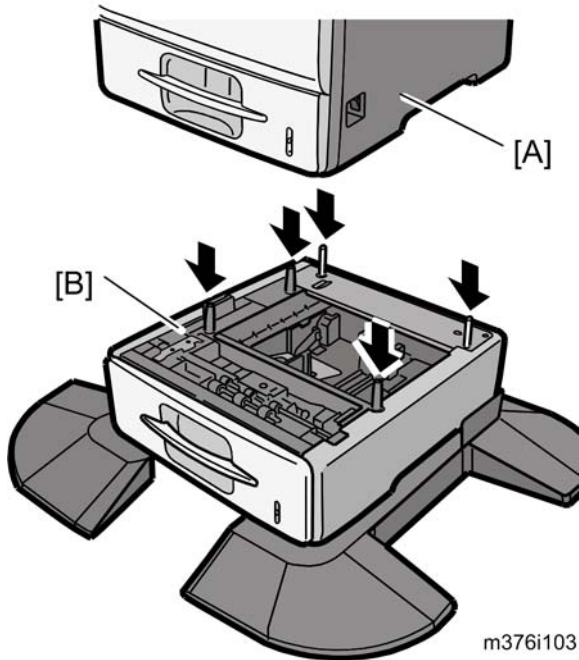

4. Set the machine [A] on the paper feed unit [B].
 - Two people are required to lift the machine.

Note

- When installing a second paper feed unit, place it on the first paper feed unit before placing the printer onto the pair of paper feed units
5. Remove the paper(s) tray from the paper tray unit(s).
 6. Load paper in the paper tray(s). Adjust the side and end fences as necessary. If loading 8¹/₂"x 14" paper, remove the end fence and set it in the special compartment.
 7. Insert the paper tray(s) back in the paper tray unit(s).

When stacking four optional paper feed units

Paper feed units should be fixed each other with screws when stacking four optional paper feed units. Fix the paper feed units to each other as described below.

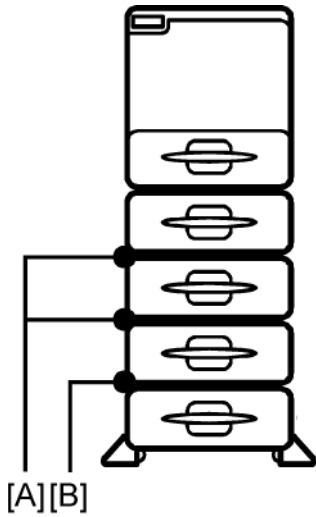

m375i102c

1. Between top three optional units [A]
2. Between the unit with casters (forth optional) and third optional unit [B].

Fixing the units together

1. Pull out the paper trays of the paper feed units to be fixed.

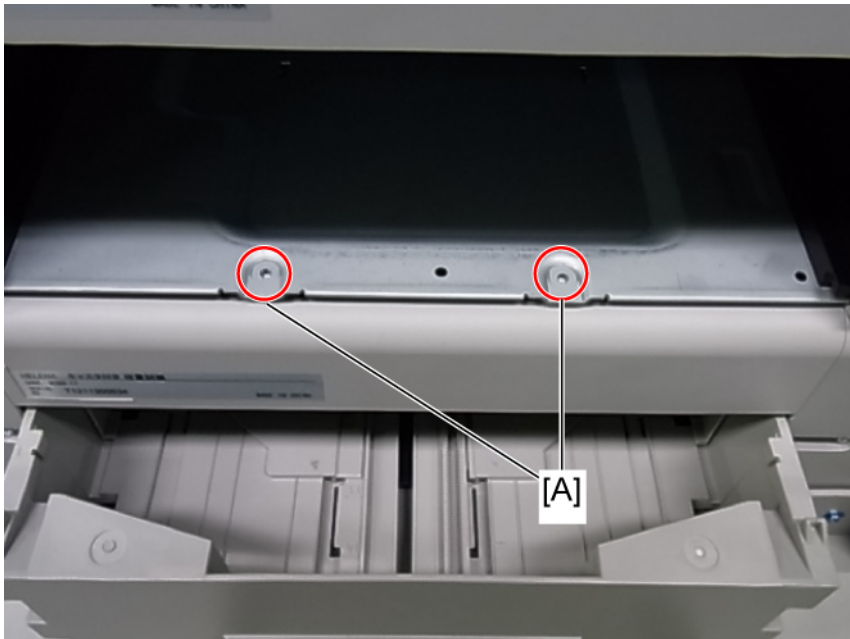

m020i003

2. Fix the paper feed unit at the rear side [A] with the two screws that come with the paper feed unit.

 **Important**

- **Never detach the stabilizers of the paper feed unit with casters (M389).**

3. Preventive Maintenance

Maintenance Tables

User Maintenance

The customer can replace all PM items with the Maintenance Kit.

The user can maintain this machine. For more see "Printer Engine Service Mode".

The operation panel shows "Replace Maintenance Kit" when the PM counter reaches 120 k. After the user replaces the fusing unit in the maintenance kit, the machine automatically resets the PM counter.

Item	Quantity	Remarks
Fusing unit	1	-
Transfer roller	1	-
Paper feed roller	5	For standard and optional tray(s)
Friction pad	5	For standard and optional tray(s)

Service Maintenance

See "Appendices" for the following information:

- Preventive Maintenance Items
- Other Yield Parts

PM Parts Settings

Before Removing the Old PM Parts

1. Enter the SP mode.
2. Output the SMC logging data with SP5-990-004.
3. Clear the PM counters with SP7-804.
4. Exit the SP mode.

3

Item	SP
All Units	7-804-002
Fusing Unit	7-804-003
Transfer Roller	7-804-004
Paper Feed Roller	7-804-005

For the fusing unit, there is a new unit detection mechanism. It is not necessary to reset the PM counter.

After Installing the New PM parts

1. Turn on the main power switch.
2. Output the SMC logging data with SP5-990-004 and check the counter values.
3. Make sure that the PM counters for the replaced units are "0" with SP7-803. If the PM counter for a unit was not reset, then reset that counter with SP 7-804.

Operation Check

Check if the sample image has been printed normally.

4. Replacement and Adjustment

General Precautions

Precautions on Disassembly

CAUTION

- Always turn off the main power switch and unplug the machine before attempting any of the procedures in this section.

Use extreme caution when removing and replacing components. The cables in the machine are located very close to moving parts; proper routing is a must.

After components have been removed, any cables that have been displaced during the procedure must be restored as close as possible to their original positions. Before removing any component from the machine, note any cable routings that may be affected.

Before servicing the machine:

1. Verify that documents are not stored in memory.
2. Remove the print cartridge before you remove parts.
3. Unplug the power cord.
4. Work on a flat and clean surface.
5. Replace with authorized components only.
6. Do not force plastic material components.

Make sure all components are returned to their original positions.

Laser Unit

1. Do not loosen or adjust the screws securing the LD drive board on the LD unit. Doing so will throw the LD unit out of adjustment.
2. Do not adjust the variable resistors on the LD unit, as these are permanently adjusted at the factory. If replacement of the LD drive board is necessary, replace the entire LD unit.
3. Keep the polygon mirror and toroidal lens free of dust. Laser performance is very sensitive to dust on these components.
4. Do not touch the shield glass or the surface of the polygon mirror with bare hands.
5. Do not adjust the Laser Synchronization detector on the LD unit, as these are permanently adjusted at the factory.

Transfer Roller

1. Never touch the surface of the transfer roller with bare hands.

2. Be careful not to scratch the transfer roller, as the surface is easily damaged.

Fusing

1. After installing the fusing thermistor, make sure that it is in contact with the hot roller and that the roller can rotate freely.
2. Be careful to avoid damage to the hot roller stripper pawls and their tension springs.
3. Do not touch the fusing lamp and rollers with bare hands.
4. Make sure that the fusing lamp is positioned correctly and that it does not touch the inner surface of the hot roller.

Paper Feed

1. Do not touch the surface of paper feed rollers.
2. To avoid misfeeds, the side and end fences in each paper tray must be positioned correctly so as to align with loaded paper size.

Releasing Plastic Latches

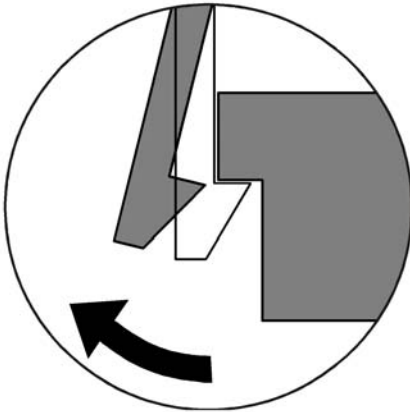

g094r513

Many of the parts are held in place with plastic latches. The latches break easily, so release them carefully. To release a latch, press the hook end of the latch away from the part to which it is latched.

After servicing the machine

1. Make sure all parts that require grounding are properly grounded.
2. Make sure the interlock switch is functioning.
3. Do not leave unused solder or parts inside the machine.
4. Do not leave any tools inside the machine.

5. Make sure all wires are properly connected and routed.
6. Make sure wires are not jammed between parts of the machine.

Covers

Right Cover

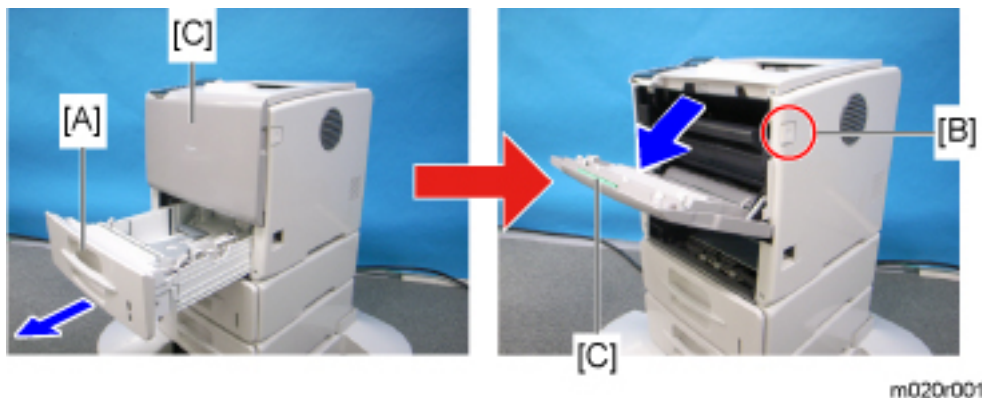

1. Pull the standard tray [A] out.
2. Gently push the front cover release button [B], and open the front cover [C].

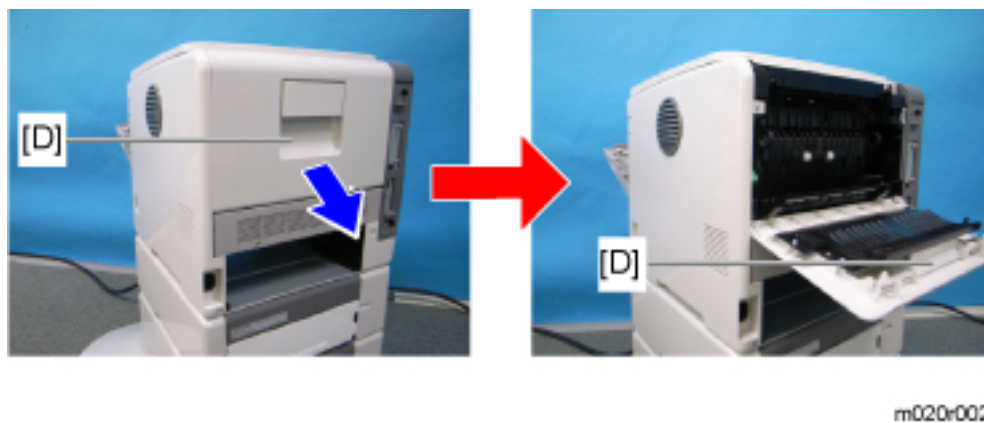

3. Open the rear cover [D].

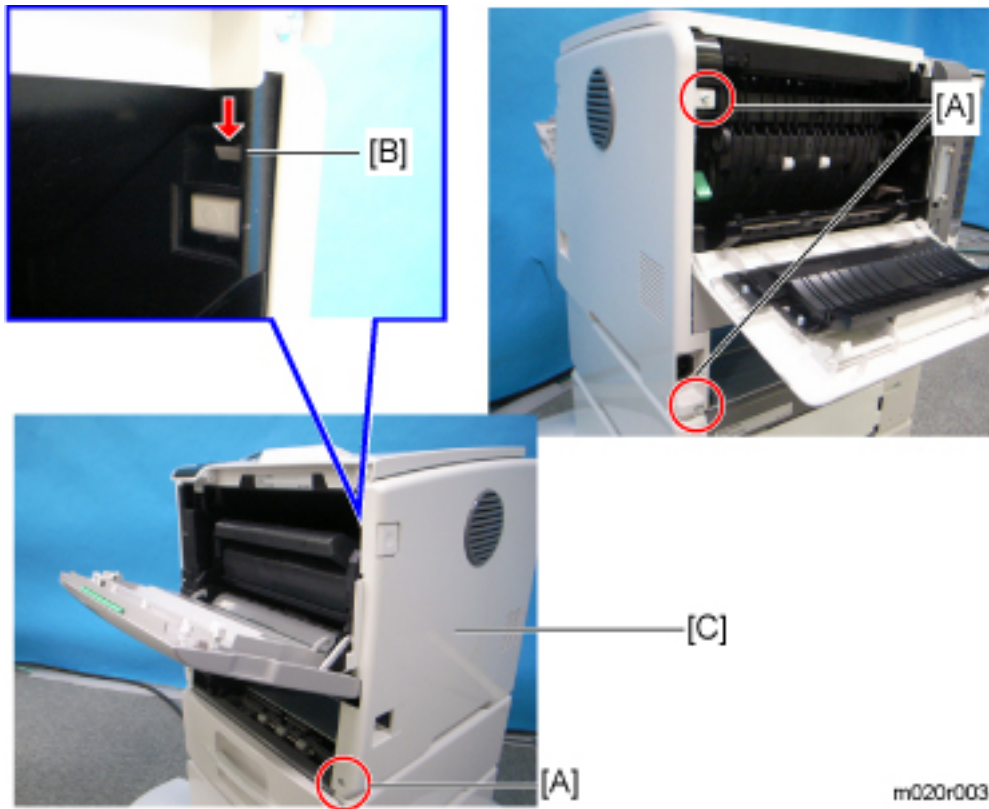



4

4. Right cover [C] ( x 3 [A], hook [B] x 1)

 **Note**

- To remove the right cover safely, release it from the power switch by pulling the cover forward and outward slightly, and then release it from the Inlet socket by pushing the cover backward slightly.

Left Cover

1. Pull the standard paper tray out ( p.56).
2. Open the front cover ( p.56).

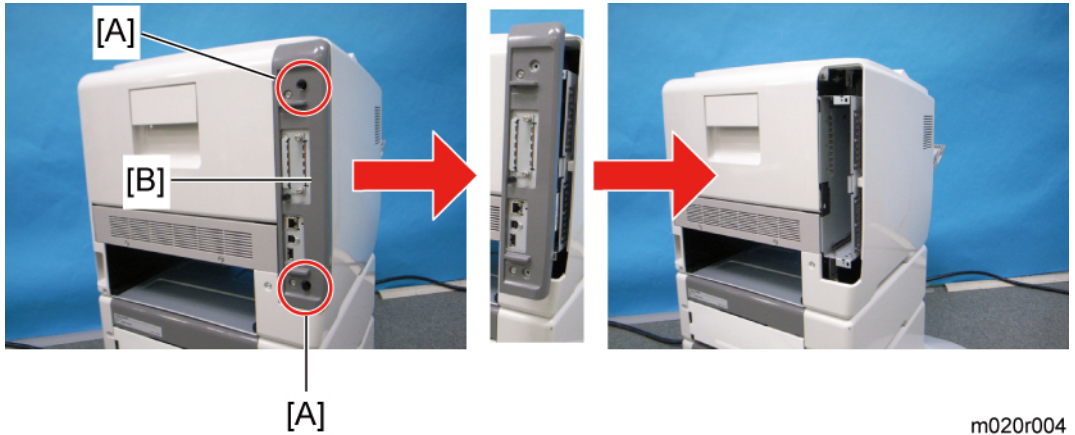

m020r004

4

3. Slide the control board unit [B] out (Knob screw [A] x 2).
4. Open the rear cover (🔧 p.56).

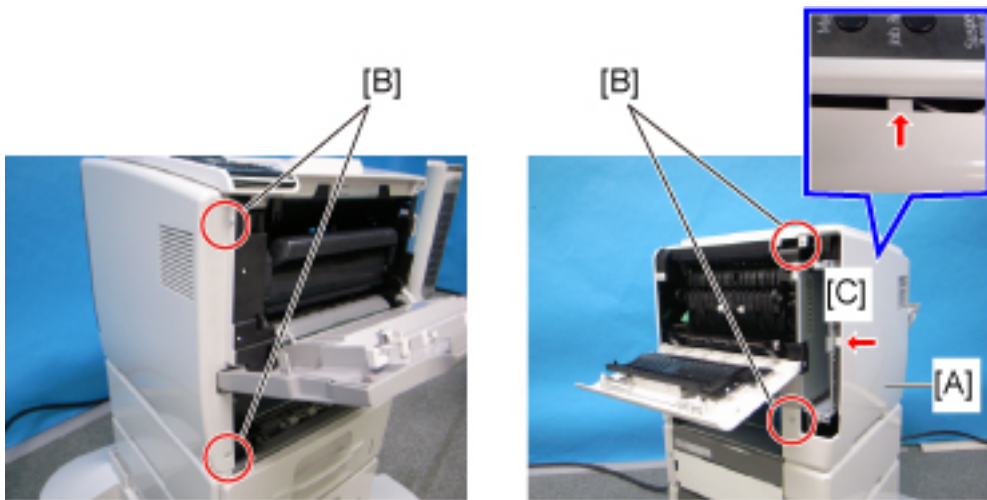

m020r005

5. Left cover [A] (🔧 [B] x 4, hooks [C] x 2).

Upper Cover

1. Right cover (🔧 p.56)
2. Left cover (🔧 p.57)
3. Open the front cover and the rear cover.

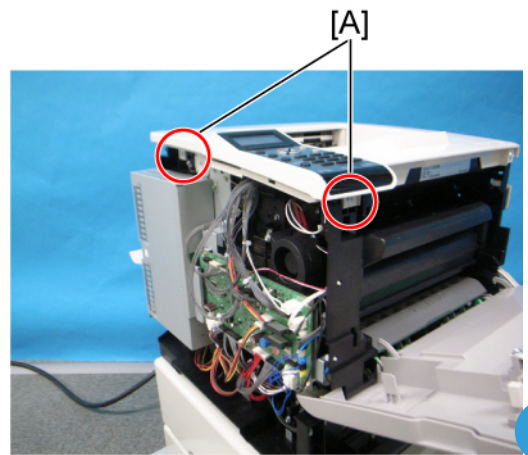
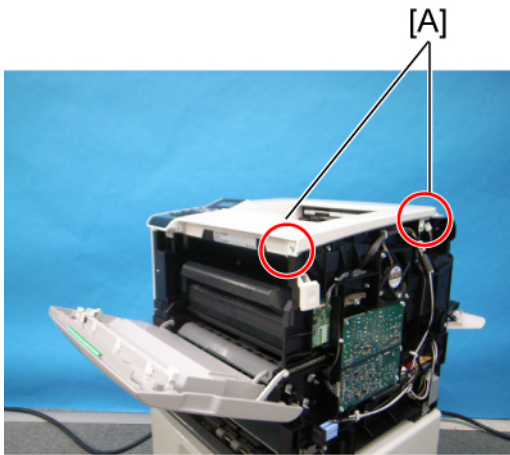

m020r006

4

4. 4 screws [A].
5. Operation panel (p.62)

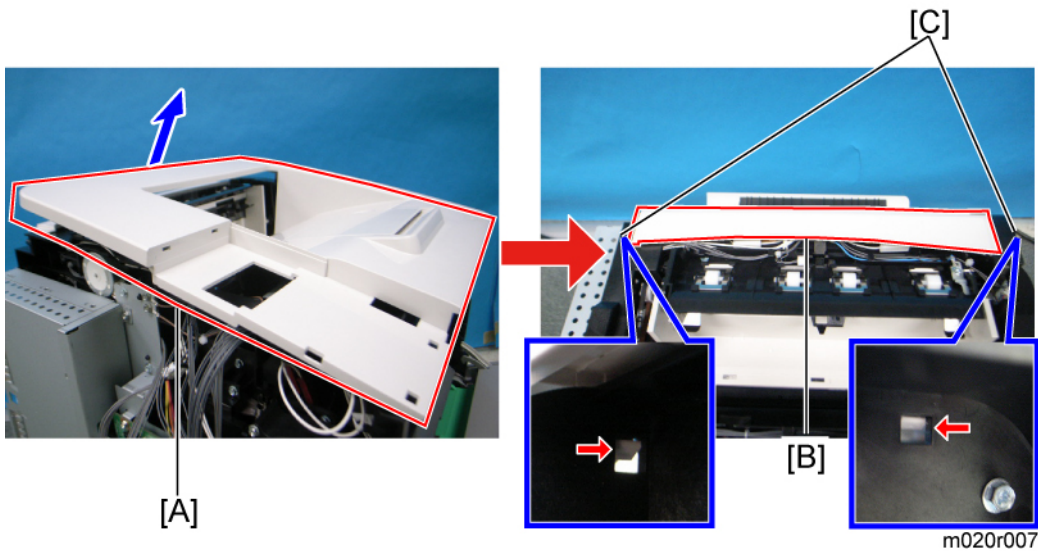

m020r007

6. Part [A] of upper cover.
7. Part [B] of upper cover (Hooks [C] x 2).

Front Cover

1. Pull out the standard paper tray.
2. By-pass tray (p.85)
3. Open the front cover [B].

4. Right cover (p.56)

5. Left cover (p.57)

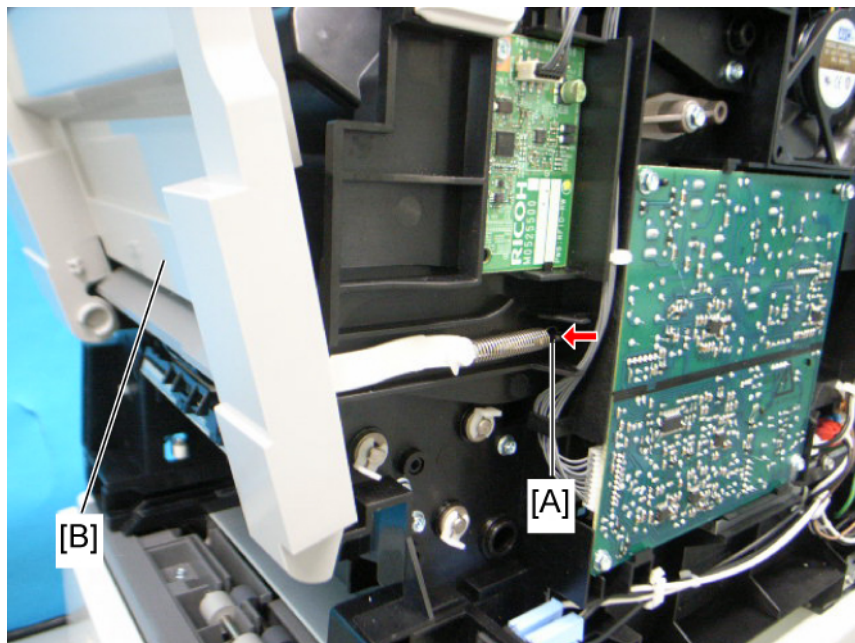

m020r008

6. Close the front cover [B].

7. Release the tension spring [A].

8. Reopen the front cover [B].

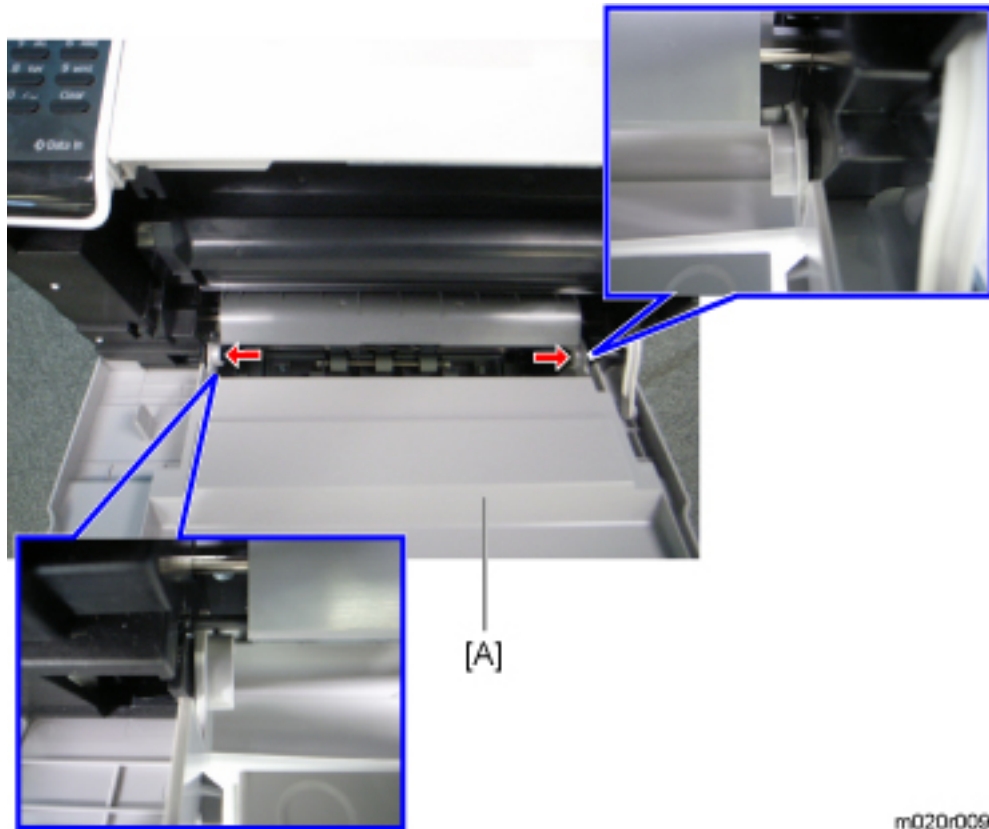

4

9. Front cover [A] (Hooks x 2).

★ Important

- Remove the by-pass tray unit before removing the front cover.
- Close the front cover before releasing the tension spring.

m020r009

Rear Cover

1. Open the rear cover.

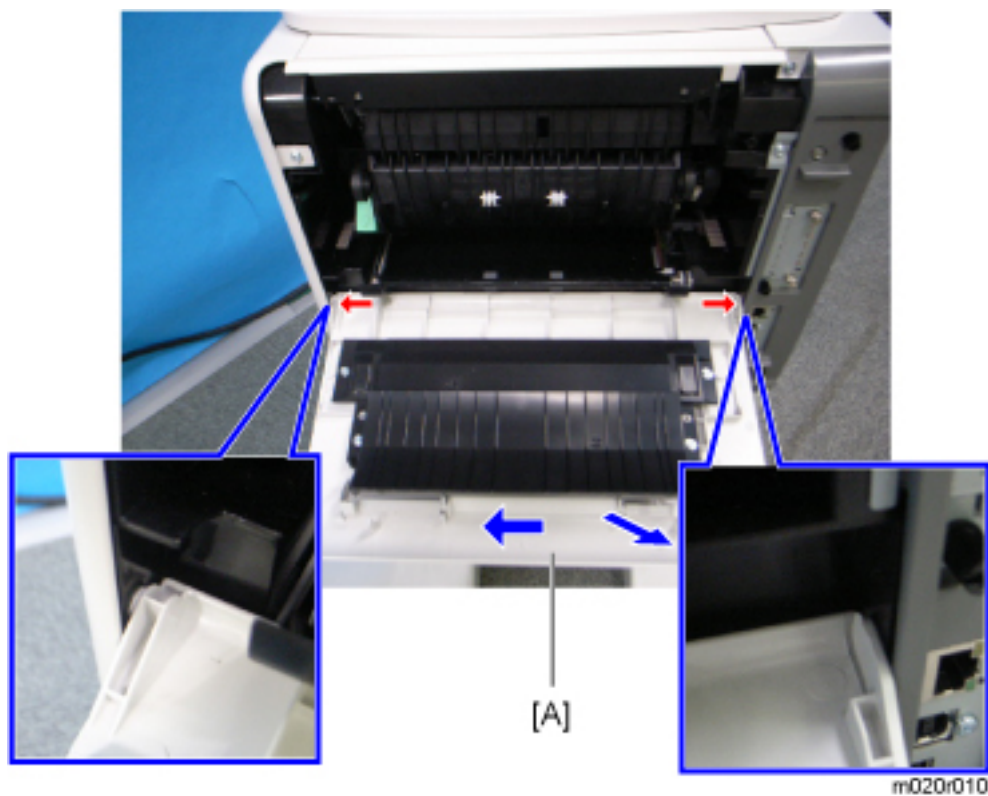

2. Rear cover [A](Hooks x 2).

Note

- To remove the rear cover easily, release the right hook by pushing the cover against the left side of mainframe lightly, and then pull out the right corner.

Operation Panel

1. Left cover (🖨️ p.57)
2. Open the front cover.

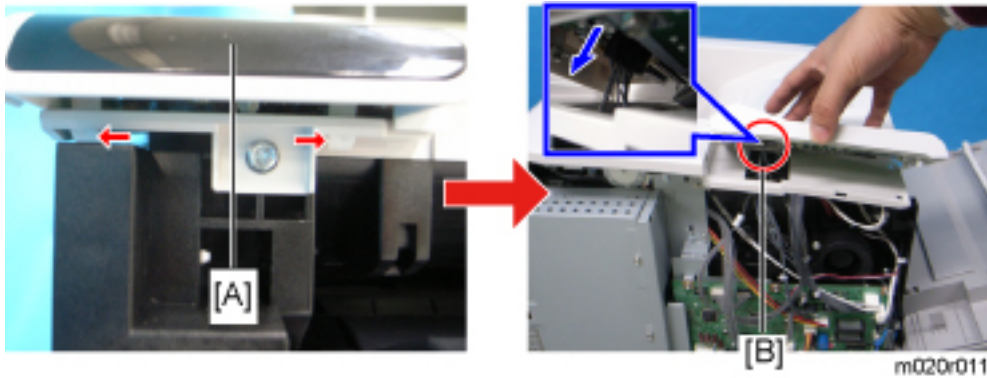

3. Operation panel [A] (📦 [B] x 1, hooks x 2).

Laser Unit

⚠ CAUTION

- Turn off the main power switch and unplug the machine before attempting any of the procedures in this section. Laser beams can seriously damage your eyes.

Caution Decal Locations

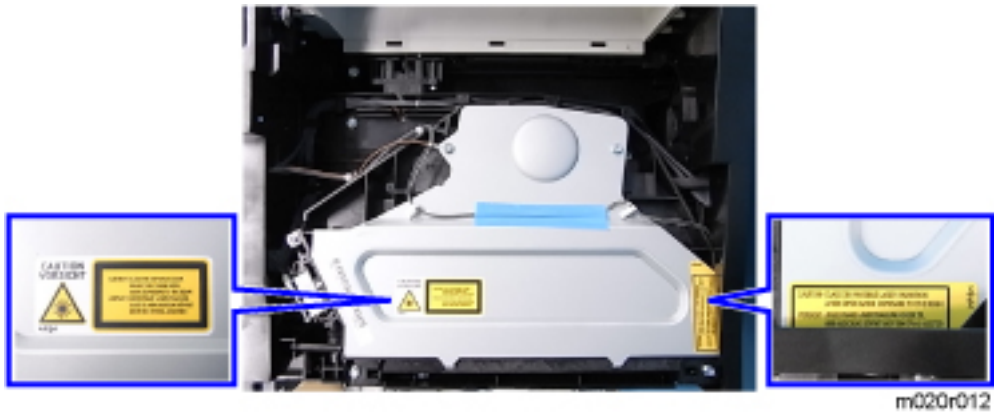

Laser Unit

⚠ CAUTION

- Turn off the main switch and unplug the machine before attempting any of the procedures in this section. Laser beams can seriously damage your eyes.

1. Right cover (🔧 p.56)
2. Left cover (🔧 p.57)
3. Upper cover (🔧 p.58)

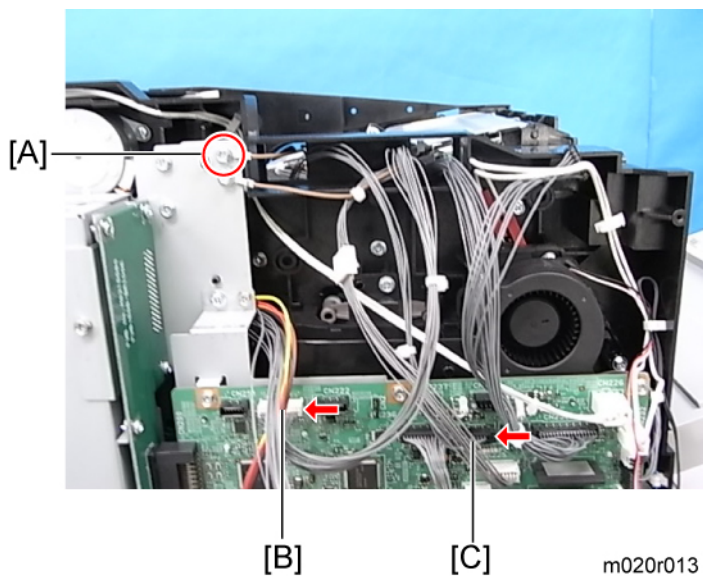

4

4. Grounding wire [A] and 2 connectors [B], [C] (⚡ x 2, grounding screw x 1).

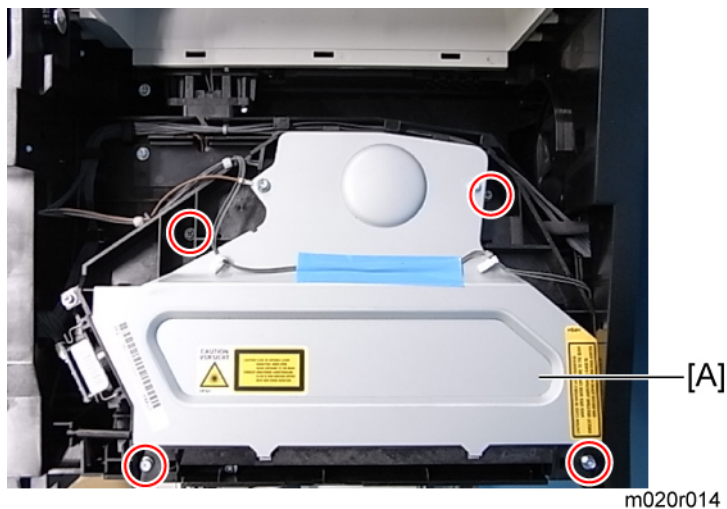

5. Laser unit [A] (⚡ x 4).

⚠ Note

- Never touch the surface of the mirror with bare hands.

When reinstalling the laser unit.

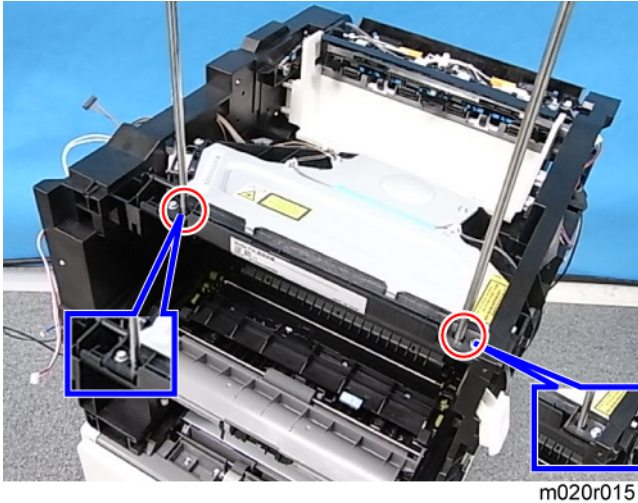

4

Note

- Use the scanner positioning pins (P/N: A0069104) to reinstall the unit.
- Set the positioning pins as shown above. Then secure the laser unit.

Polygon Mirror Motor

CAUTION

- Turn off the main switch and unplug the machine before attempting any of the procedures in this section. Laser beams can seriously damage your eyes.

1. Upper cover (p.58)
2. Laser unit (p.64)

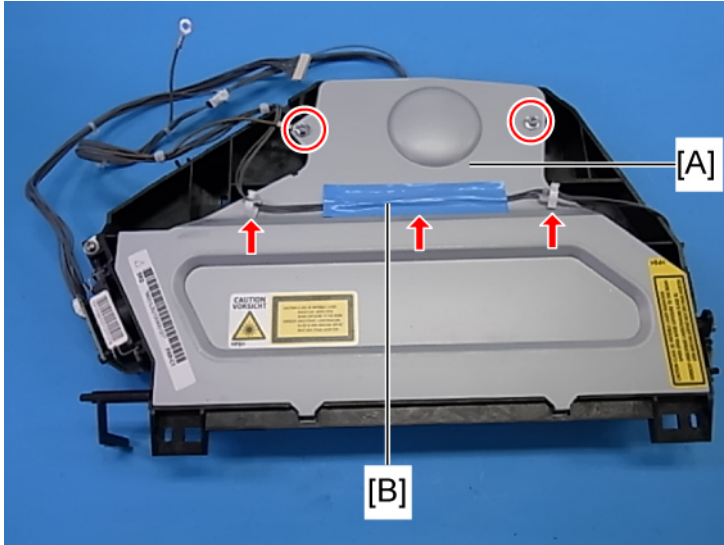

m020r014b

3. Polygon mirror cover [A] (Grounding screw x 1,  x 1,  x 2, tape x 1)

Note

- Keep the tape [B] above. The tape is necessary when reassembling the laser unit.

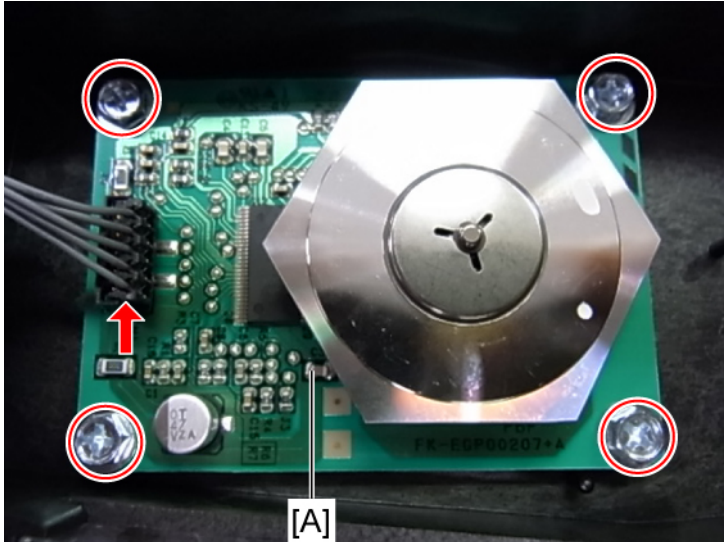

m020r014b

4. Polygon mirror motor [A] ( x 4,  x 1)

Laser Synchronization Detector

1. Laser unit ( p.64)

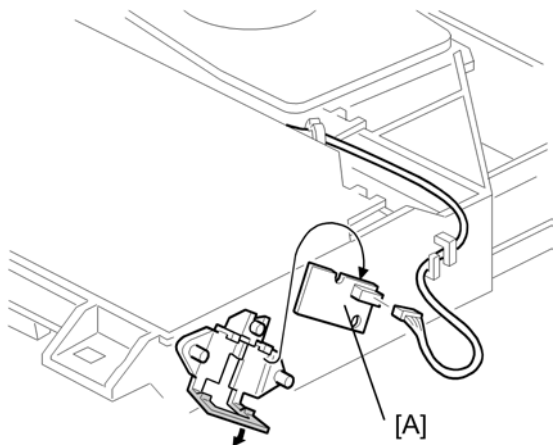

g094r519

2. Laser synchronization detector [A] (E x 1)

Transfer Roller

1. Open the front cover.
2. Remove the AIO unit.

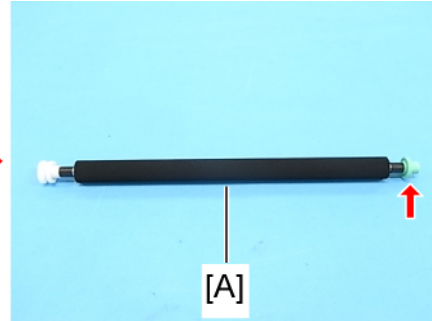
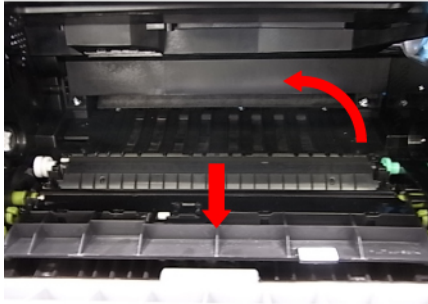

m020r016

3. Remove the transfer roller [A] as shown above.

↓ Note

- Do not touch the transfer roller surface.
- Set the transfer roller with its green end (indicated by the arrow in the upper-right photo) on the right side.
- Make sure that the transfer roller is set securely.

Fusing

Fusing Unit

⚠ CAUTION

- Before handling the fusing unit, make sure that the unit is cool enough. The fusing unit can be very hot.

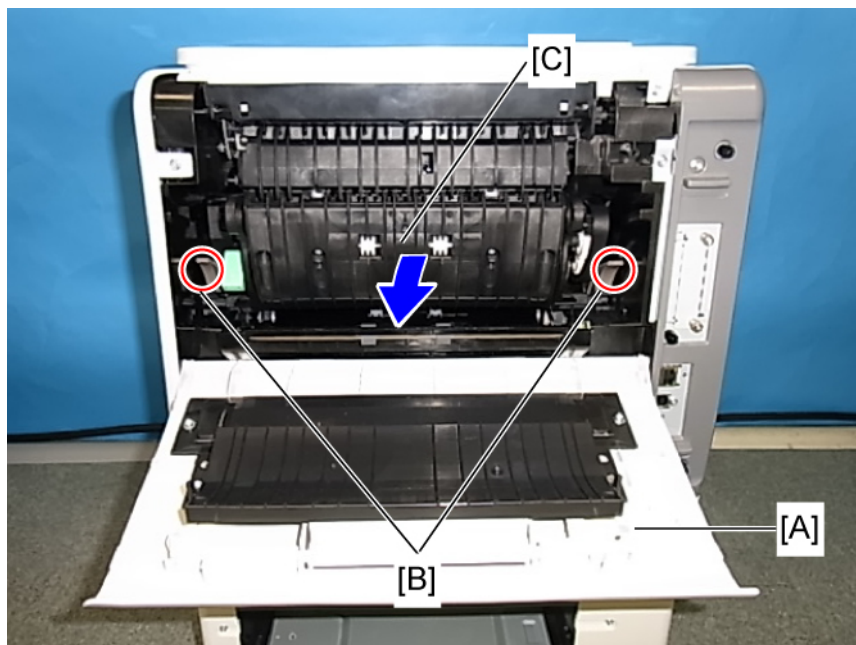

m020r095



1. Open the rear cover [A].
2. Release the lock levers [B].
3. Pull the fusing unit [C] out.

Hot Roller and Pressure Roller Sections

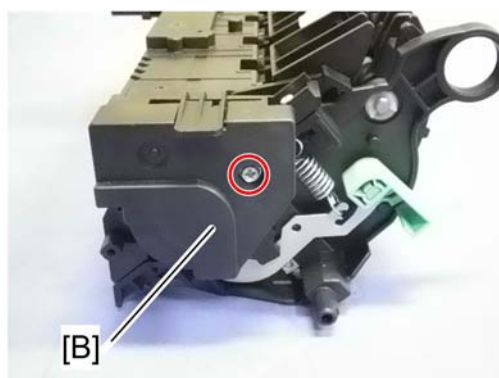
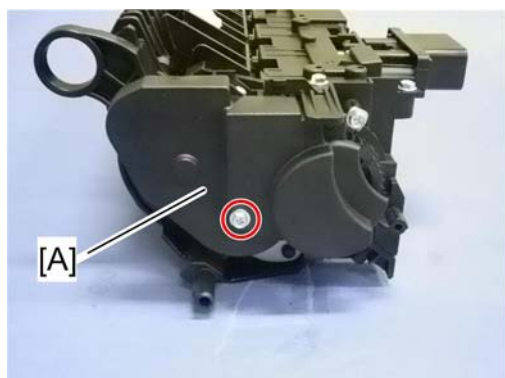
1. Fusing unit (📄 p.70)



m052r301

2. Fusing left cover [A] ( x 1)
3. Fusing right cover [B] ( x 1)

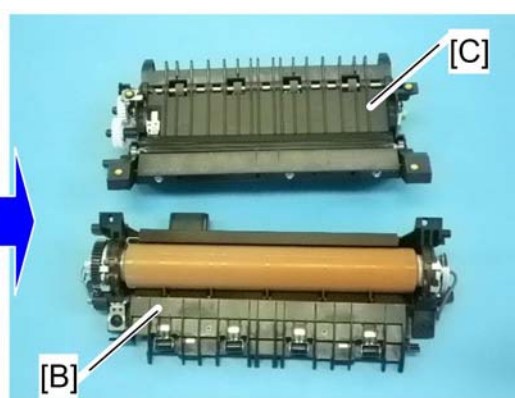
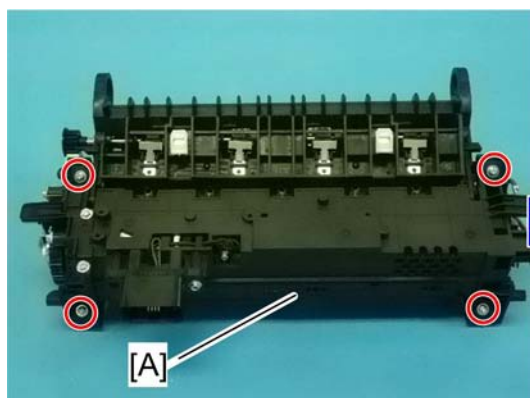

4



m052r302

4. Separate the fusing unit [A] into the hot roller section [B] and the pressure roller section [C] ( x 4).

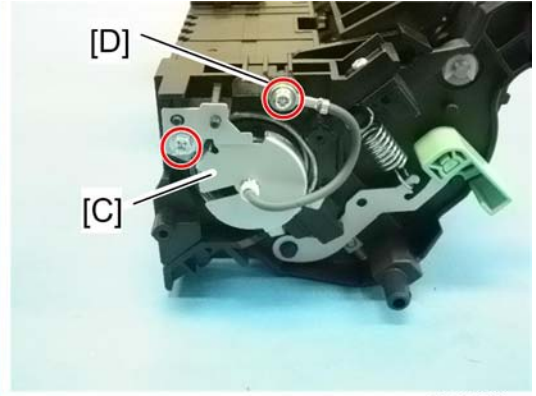
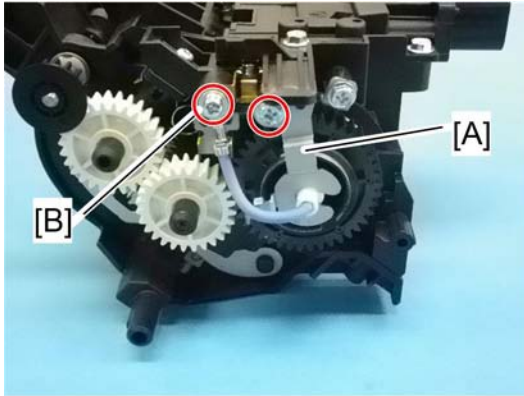

Fusing Lamp

1. Fusing unit ( p.70)
2. Fusing left and right covers ( p.70)



m052r303

4

3. Lamp left stay [A] ( x 1)
4. Remove the screw [B] on the left terminal of the fusing unit.
5. Lamp right stay [C] ( x 1)
6. Remove the screw [D] on the right terminal of the fusing unit.

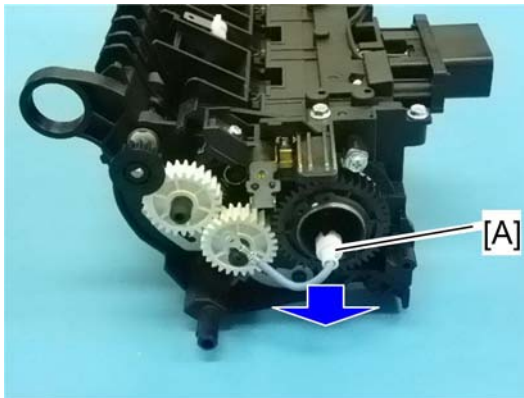



m052r304

7. Fusing lamp [A]

Hot Roller

CAUTION

- Do not touch the fusing lamp and rollers with your bare hands.

1. Hot roller section ( p.70)
2. Fusing lamp ( p.71)

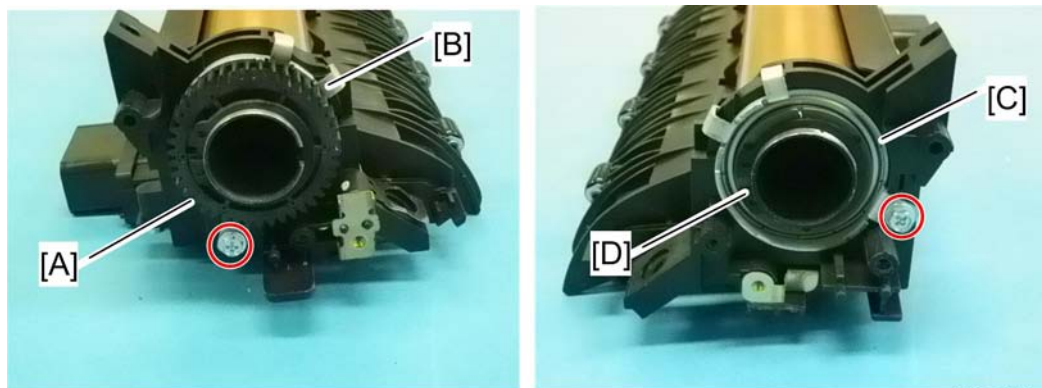

m052r305

3. Hot roller gear [A] (⌀ x 1)
4. Hot roller left stay [B] (⌀ x 1)
5. Hot roller right stay [C] (⌀ x 1)
6. Remove the c-ring [D].

4

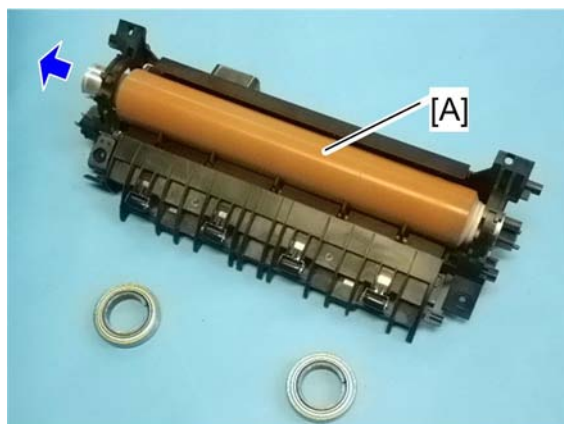

m052r306

7. Hot roller [A] (bearing x 2, insulator x 2)
 - Slowly pull out the hot roller from the hot roller section, making sure not to damage the hot roller on the stripper pawls.

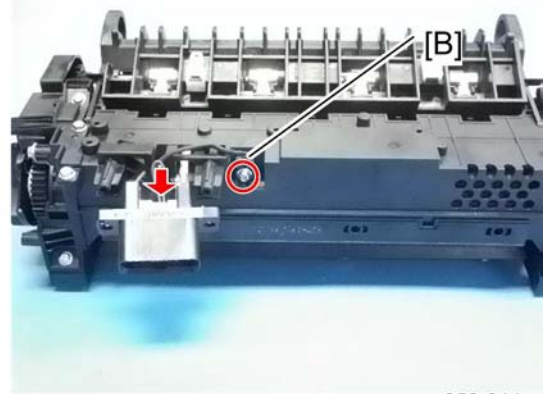
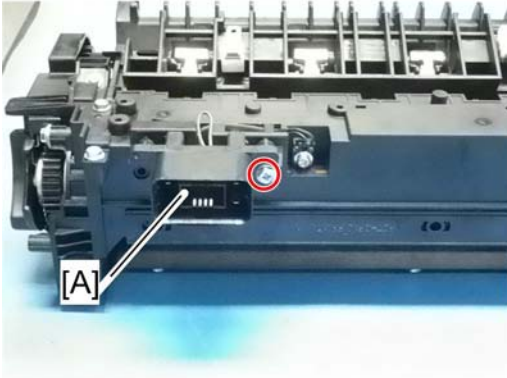

Fusing Thermistor

1. Fusing unit (p.70)



m052r311

4

2. Fusing drawer connector [A] ( x 1)
3. Fusing thermistor [B] ( x 1,  x 1)

Thermostats

1. Hot roller ( p.72)

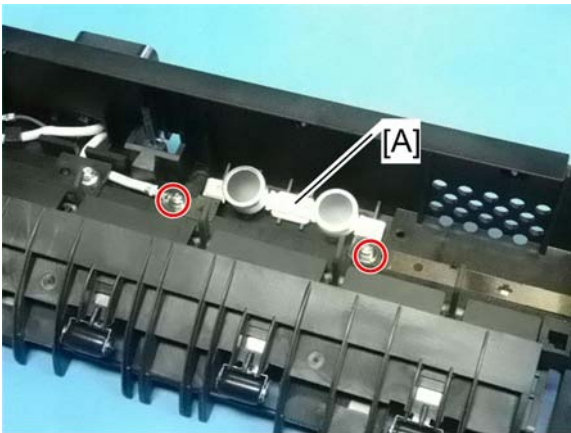

m052r307

2. Thermostats [A] ( x 2)

⚠ CAUTION

- Do not reuse thermostats that are already opened. Safety is not guaranteed if you do this.

Pressure Roller

1. Pressure roller section ( p.70)

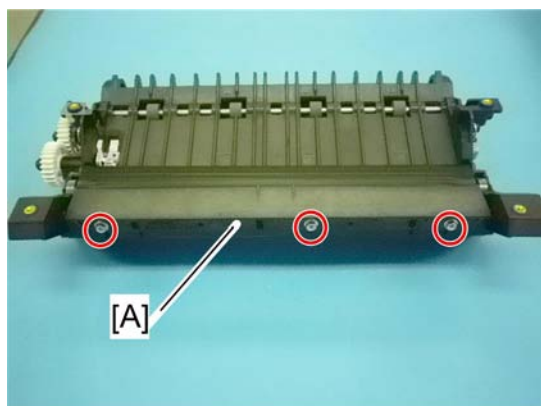

m052r308

2. Fusing entrance guide [A] ( x 3)



4



m052r309

3. Pressure roller [A] (bearing x 2)

Fusing Cleaning Roller

1. Pressure roller section ( p.70)
2. Pressure roller ( p.74)

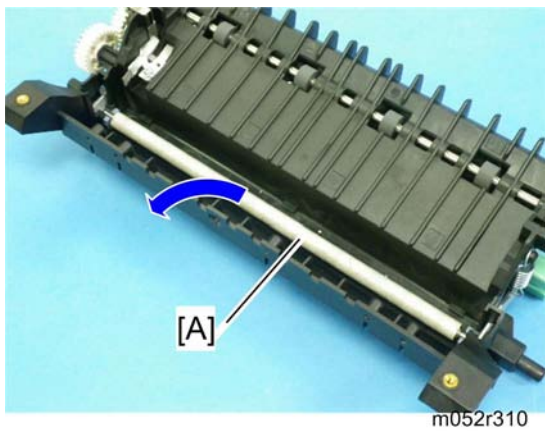

4

3. Fusing cleaning roller [A]

Paper Feed

Paper Feed Roller

1. Pull out the paper tray before removing the paper feed roller.

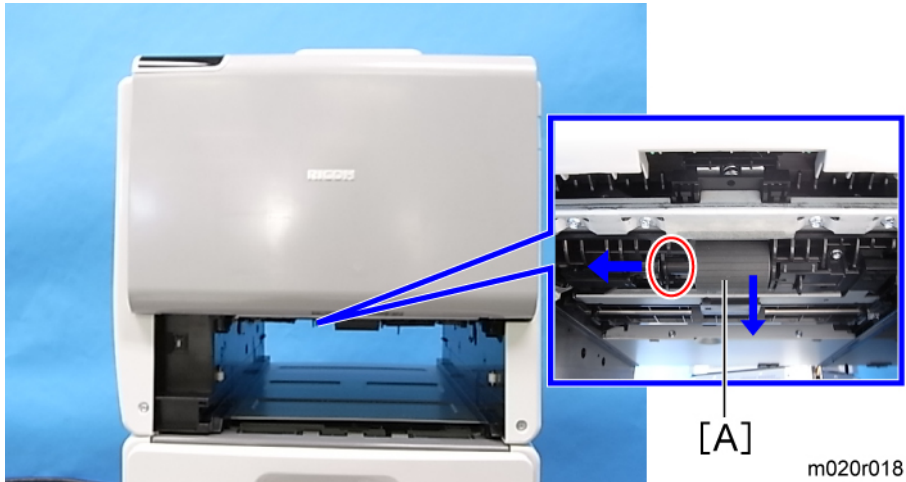

2. Press the paper feed roller [A] to the left side and remove it.

Friction Pad

1. Remove the paper tray from the machine before removing the friction pad.

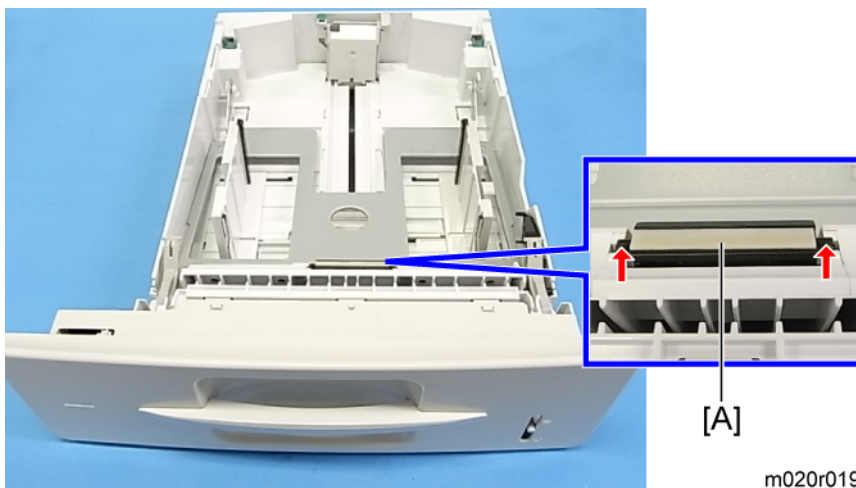

2. Friction pad [A] (Hooks x 2, spring x 1).

When reinstalling the friction pad follow this order:

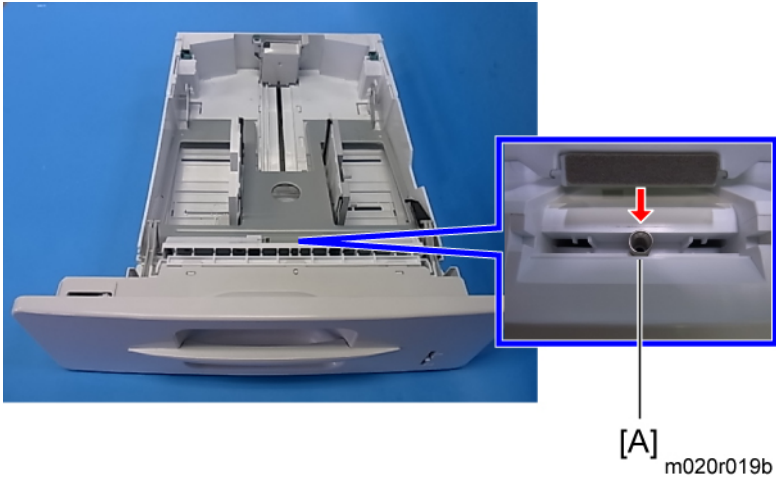

4

1. Place the spring [A].

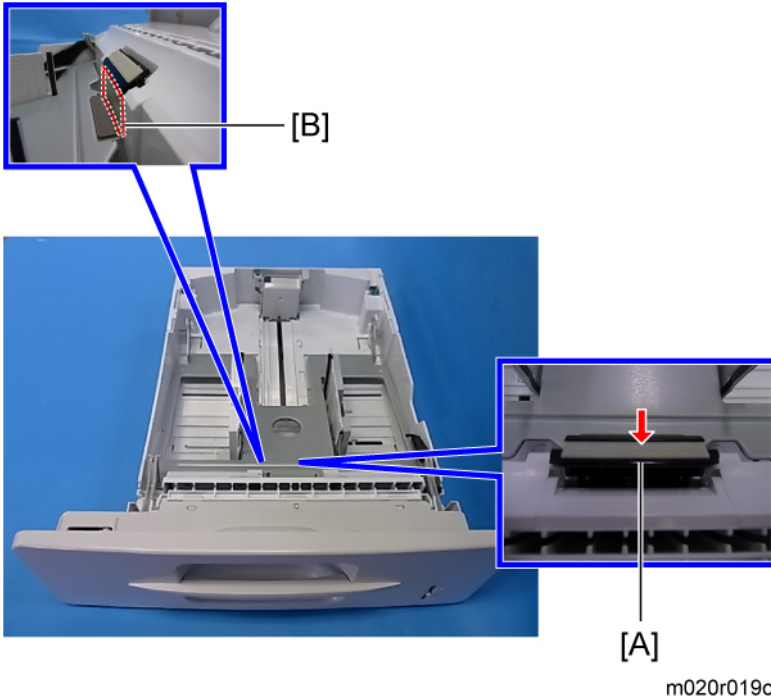

2. Gently push the friction pad [A] down into the slot while bending the Mylar sheet [B] slightly outward.

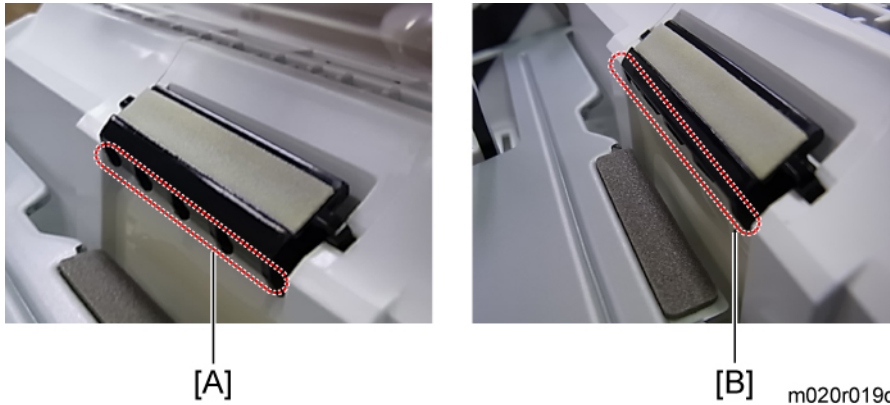

★ Important

- A: No Good -- The friction pad catches the Mylar sheet.
- B: Good -- Mylar sheet located at outside of the friction pad.
- To prevent the friction pad from catching on the Mylar sheet, place the friction pad while bending the Mylar sheet slightly outward.

Paper End Sensor

1. All optional paper tray units.
2. Pull the standard paper tray out.
3. AIO unit.
4. Fusing unit (📄 p.70)
5. Transfer roller (📄 p.69)



m020r020

6. Lay down the machine face up.
7. Feeler cover [A] ( x 1).

★ Important

- Confirm that all paper trays are detached from the machine before lying it down.
- Take care when handling this machine because of its weight. (Approximately 23 kg/51 lb)

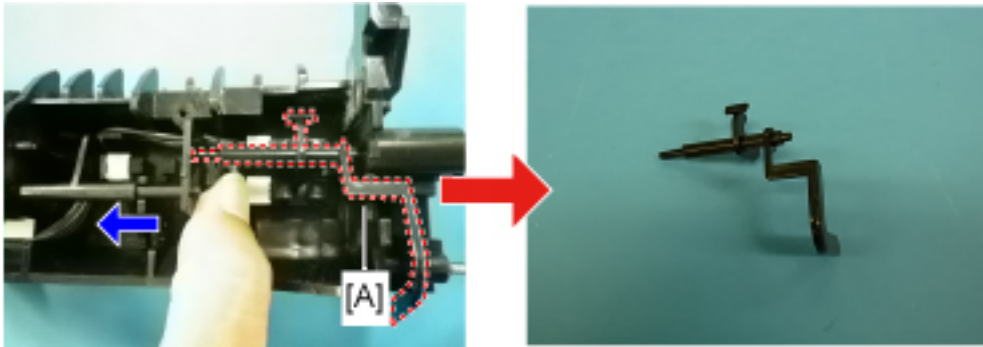

m020r021

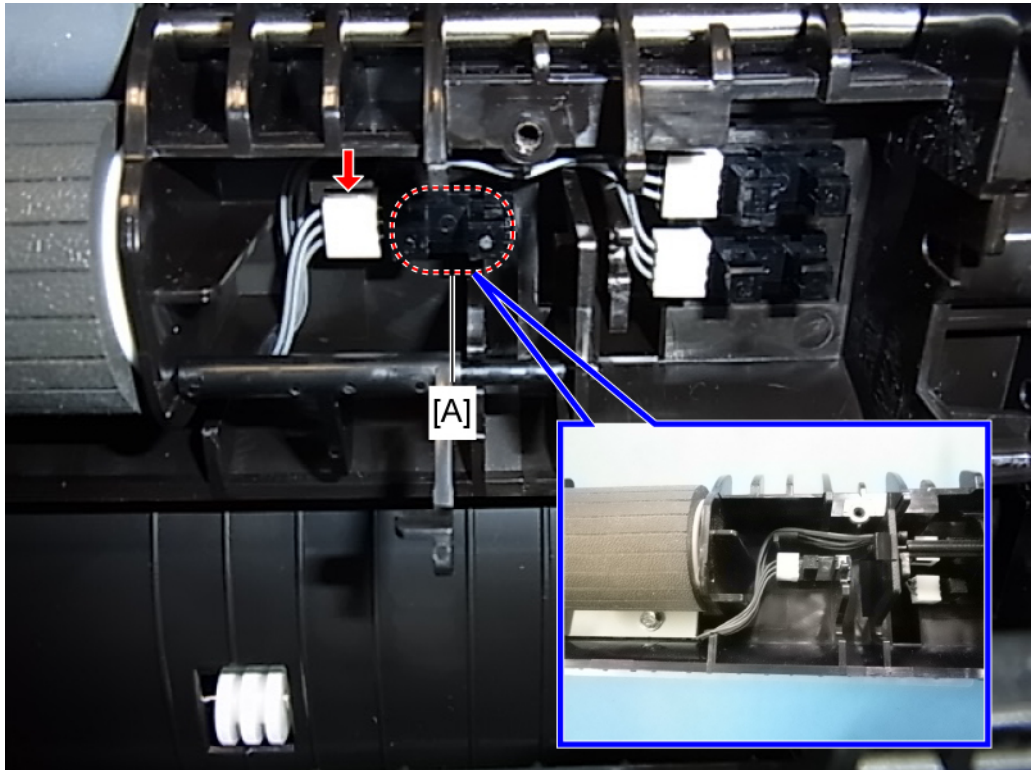

8. Remove the feeler [A] by bending the bushing slightly in the direction indicated by the arrow in the left photo.



m020r022a

9. Paper end sensor [A] (Hooks x 3,  x 1) .

Remaining Paper Sensors 1 and 2

1. All optional paper tray units
2. Pull the standard paper tray out.
3. AIO unit.
4. Fusing unit ( p.70)
5. Transfer roller ( p.69)



m020r020

6. Lay down the machine face up.
7. Feeler cover [A] ( x 1).

★ Important

- Confirm that all paper trays are detached from the machine before lying it down.
- Take care when handling this machine because of its weight. (Approximately 23 kg/51 lb)

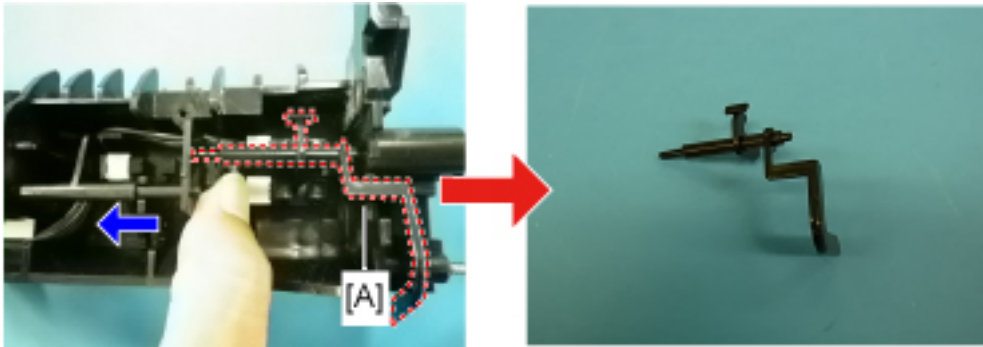

m020r021

8. Remove the feeler [A] by bending the bushing slightly in the direction indicated by the arrow in the left photo.

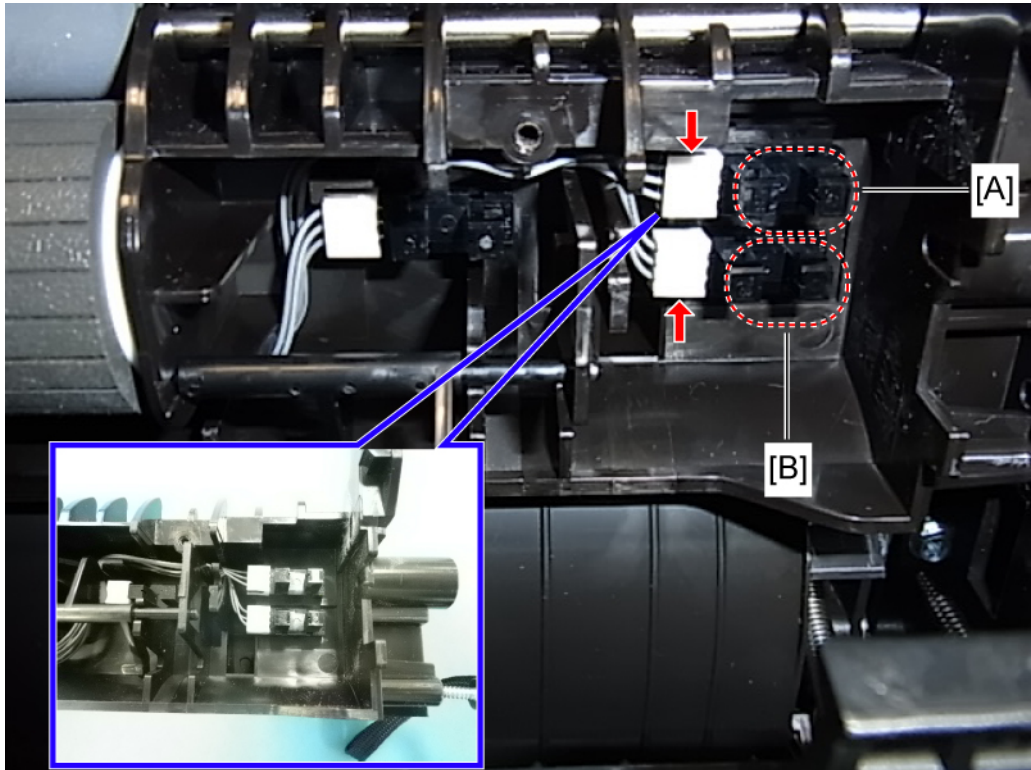

m020r022b

9. Remaining paper sensor 1 [A] and remaining paper sensor 2 [B] (Hooks x 3 (For each sensor),  x 1 (For each sensor)).

Registration Sensor

1. Open the Front cover.
2. AIO unit.

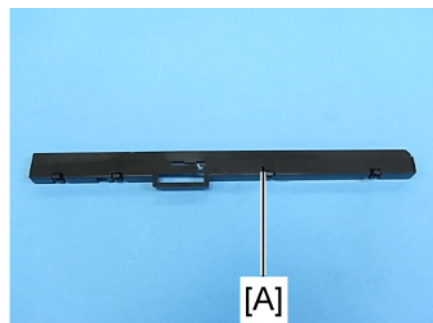
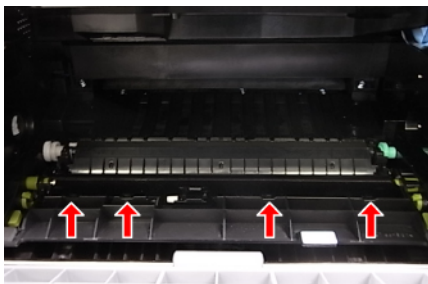

m020r023

3. Sensor cover [A] (Hooks x 4).

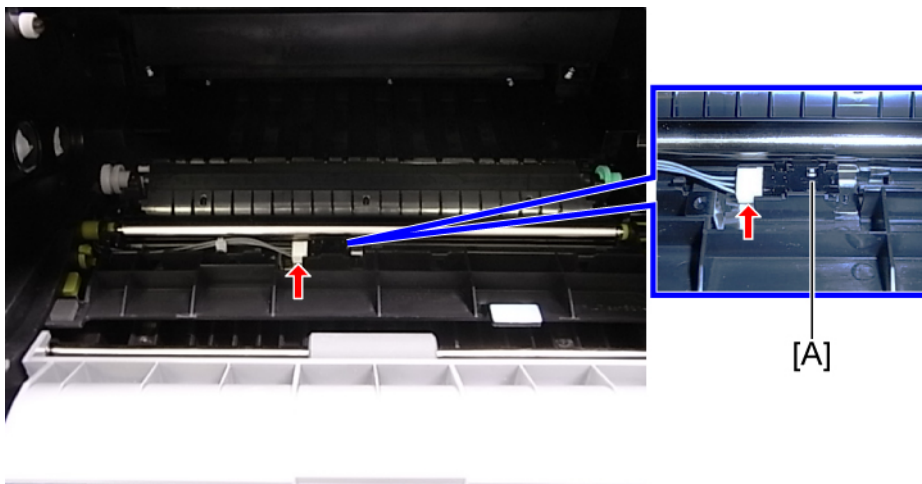

4. Registration sensor [A] (📎 x 1).

m020r024

By-pass Tray

By-pass Tray unit

1. Pull the standard paper tray out.
2. Open the by-pass tray.

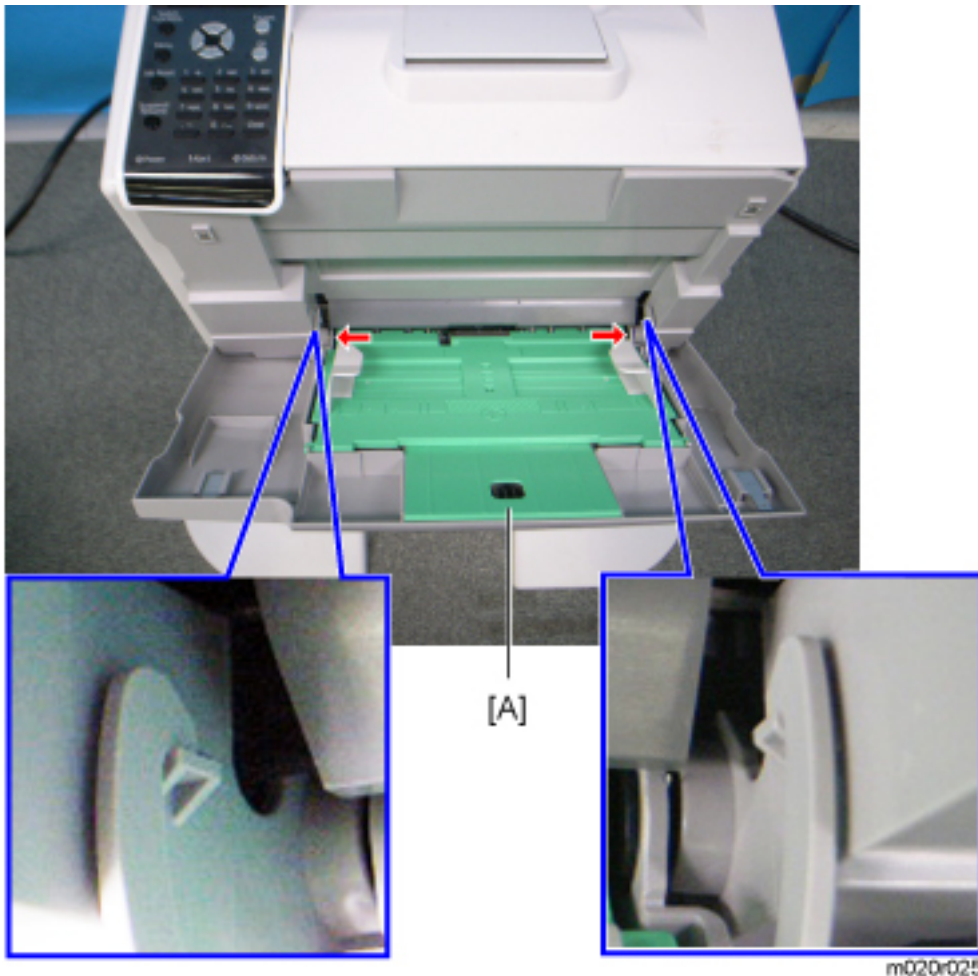

3. Bend two hooks [A] inward slightly and release them.
4. Pull the by-pass tray [A] obliquely down and remove it.

By-pass Feed Roller

1. Left cover (🖱️ p.57)

2. Right cover (🔧 p.56)
3. Front cover (🔧 p.59)
4. Remove the AIO unit.
5. Engine board with bracket (🔧 p.103)

4

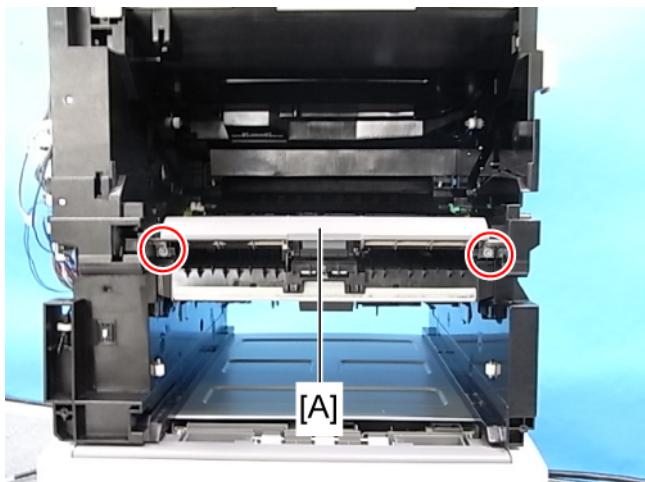

m020r026

6. Paper guide [A] (🔧 x 2).

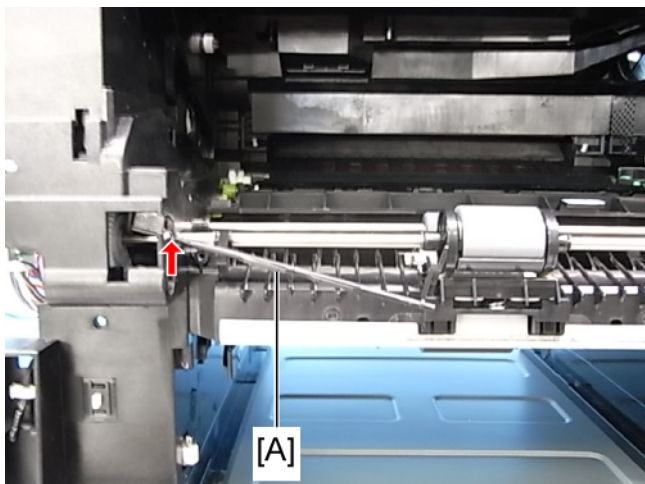

m020r027

7. Actuator [A].
8. By-pass feed clutch (🔧 p.116)

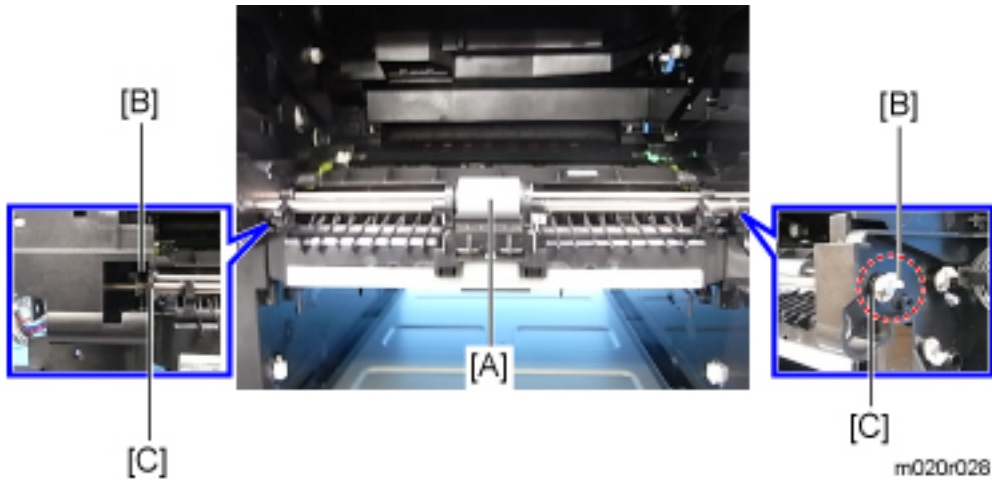

9. By-pass feed roller [A] (⌘ [B] x 2, bushing x 2 [C]).

★ Important

- Before attaching the paper guide, confirm that the actuator and the by-pass feed roller are installed securely and that they move smoothly.

By-pass Friction Pad

1. By-pass feed roller (📄 p.85)

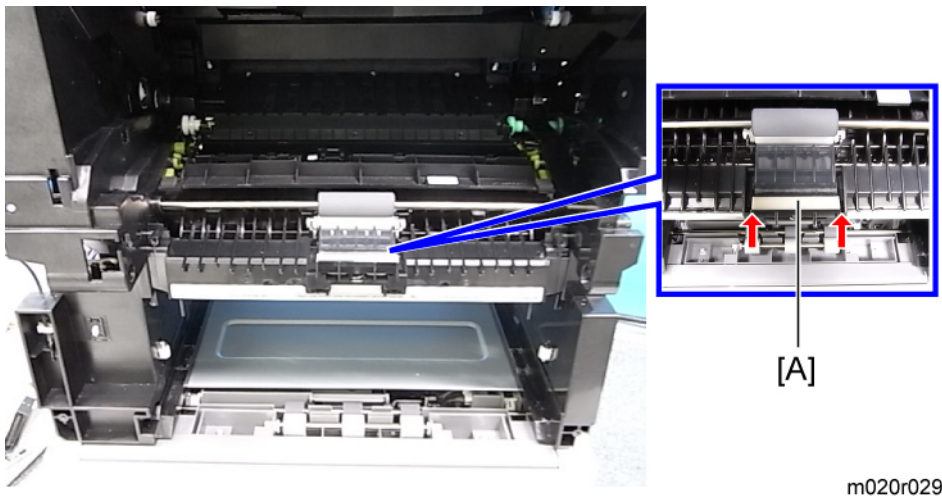

2. By-pass friction pad [A] (hooks x 2).

By-pass Paper Sensor

1. Left cover (🔧 p.57)
2. Engine board with bracket (🔧 p.103)
3. By-pass feed clutch (🔧 p.116)

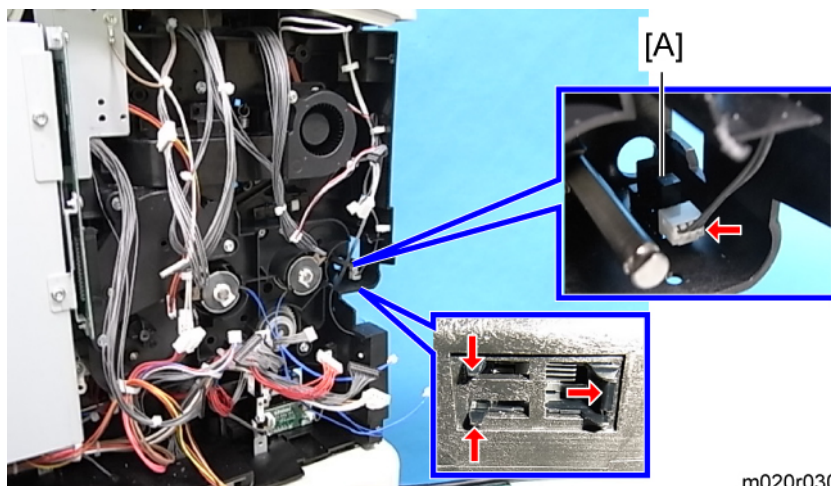

m020r030

4. By-pass paper sensor [A] (Hooks x 3, 📄 x 1).

Duplex

Duplex Unit

1. Open the rear cover.

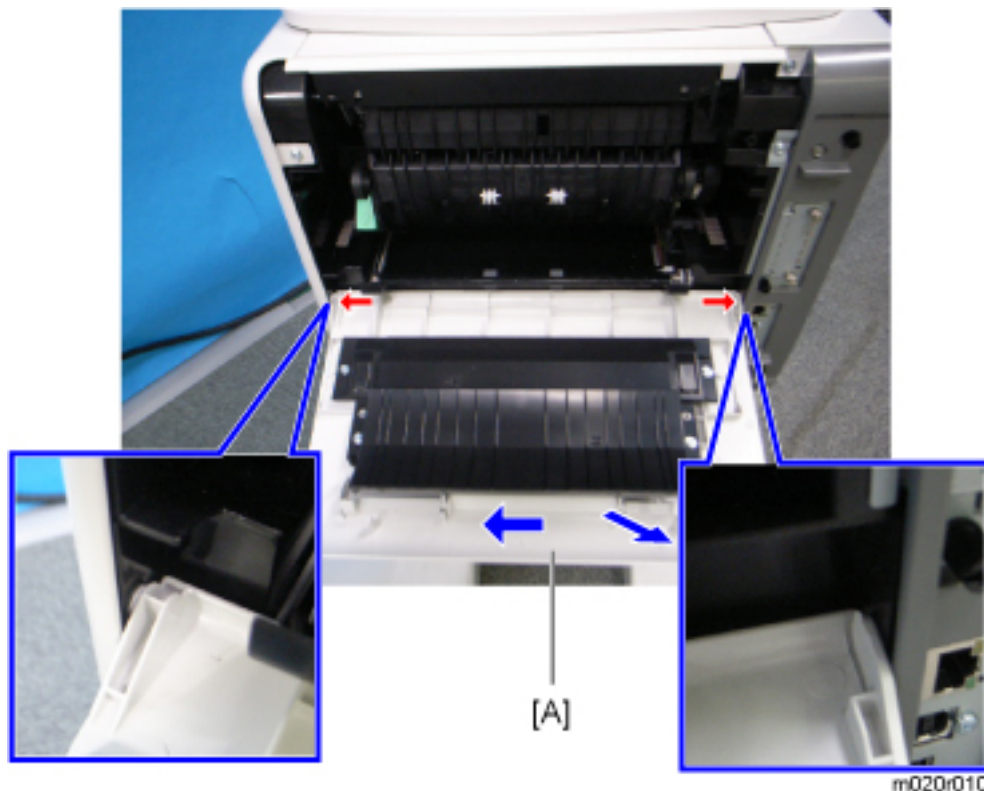

2. Duplex unit [A] (Rear cover) (Hooks x 2).

Note

- To remove the rear cover easily, release the right hook while pushing the cover against the left side of mainframe lightly, and then pull the right corner out. Then, remove the whole rear cover.

Duplex Entrance Sensor

1. Right cover (p.56)
2. Left cover (p.57)
3. Upper cover (p.58)
4. Upper cover part (p.58)

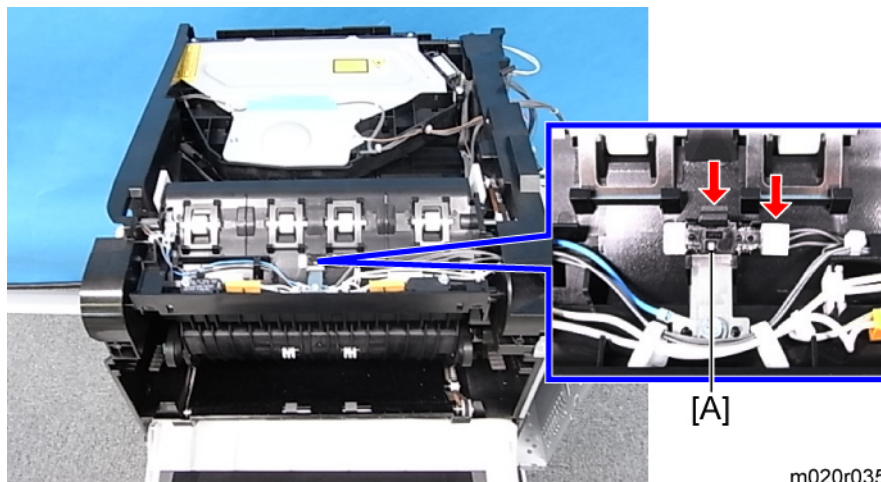

4

5. Duplex entrance sensor [A] (🔧 x 1, hook x 1).

Duplex Relay Sensor

1. Left cover (🔧 p.57)
2. Engine board with bracket (🔧 p.103)
3. Controller box (🔧 p.97)
4. Rear cover (🔧 p.61)
5. Duplex motor (🔧 p.129)

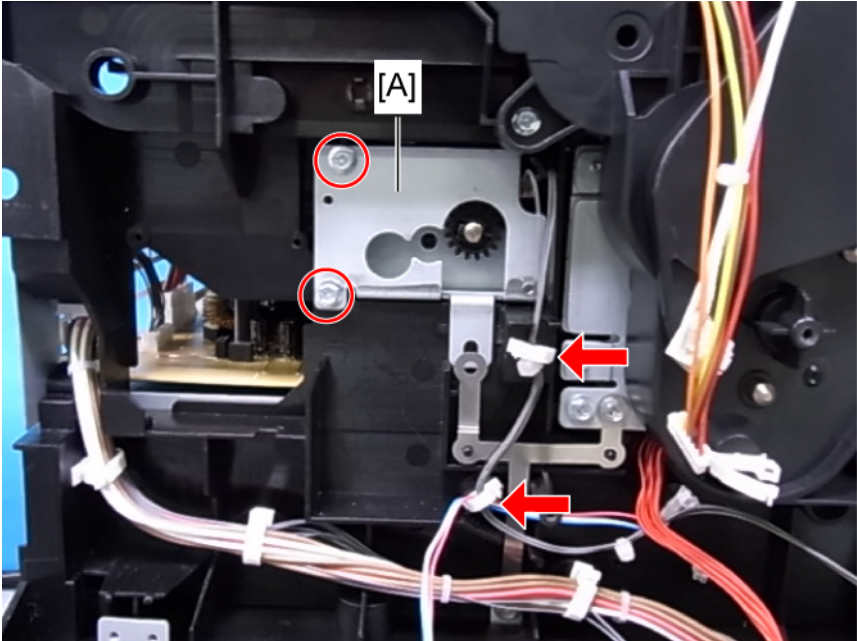

m020r036

6. Remove 2 screws and release 2 hooks.

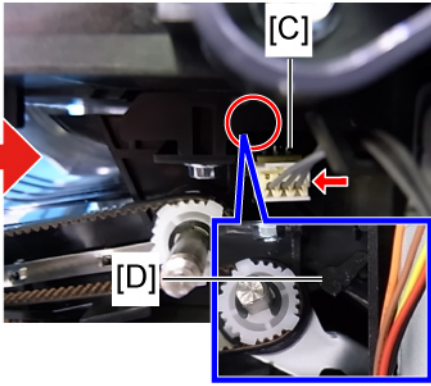
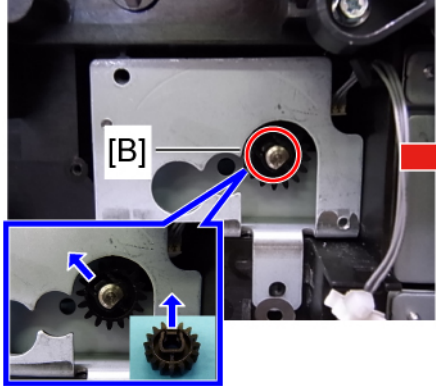

m020r037

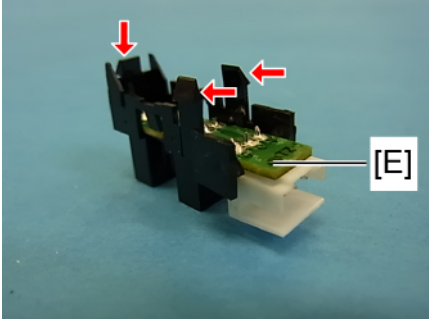

m020r038

7. Lift up the stopper on the gear (the direction indicated by the blue arrows) with a small screwdriver, and then remove the gear [B].
8. Duplex motor gear assembly [A]
9. Disconnect the connector [C].
10. Remove the Duplex relay sensor [E], being careful not to snag the feeler [D] as you remove it.
(Hooks x 3)

Paper Exit

Paper Overflow Sensor

1. Right cover (🔧 p.56)
2. Left cover (🔧 p.57)
3. Upper cover (🔧 p.58)
4. Engine board with bracket (🔧 p.103)
5. Controller box (🔧 p.97)

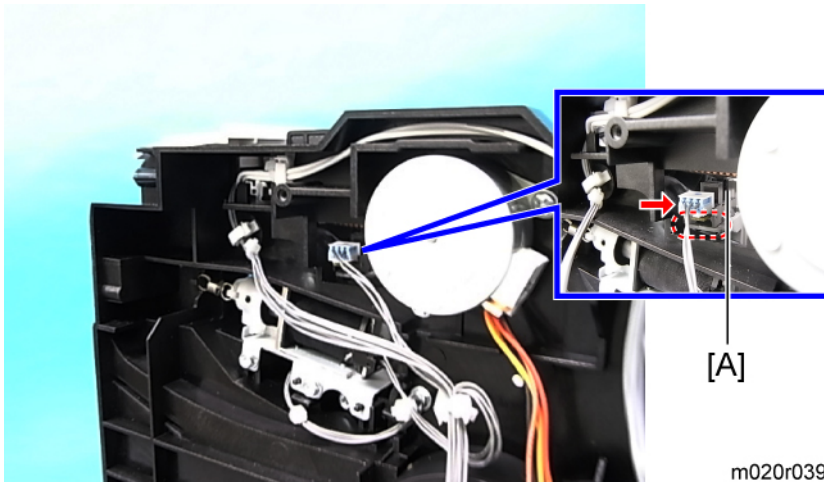

6. Paper overflow sensor [A] (🔧 x 1, hooks x 3).

⬇ Note

- Remove the paper overflow sensor while lifting the feeler up.
- Use a small minus screwdriver to release the hooks of the sensor.

When reinstalling the Paper Overflow Sensor:

Make sure the feeler is fitted into the sensor's notch.

Paper Exit Sensor

1. Left cover (🔧 p.57)
2. Engine board with bracket (🔧 p.103)
3. Controller box (🔧 p.103)

4

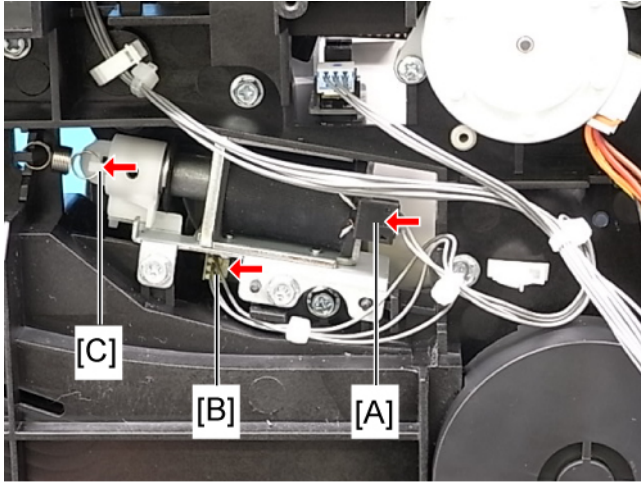

m020r090

4. 2 connectors [A], [B] and the spring [C].

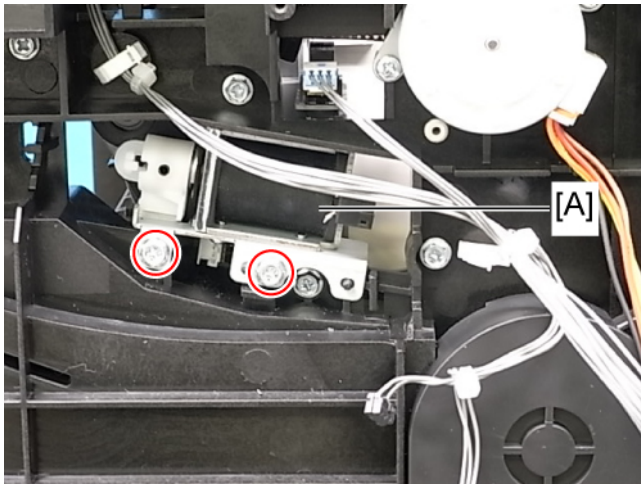

m020r091

5. Duplex junction solenoid [A] ( x 2).

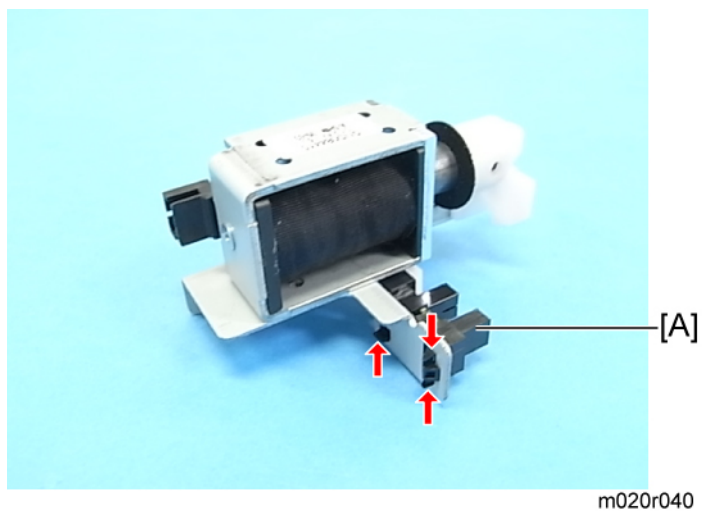

m020r040

6. Paper exit sensor [A] (E x 1, hooks x 3).

Electrical Components

Controller Board

4

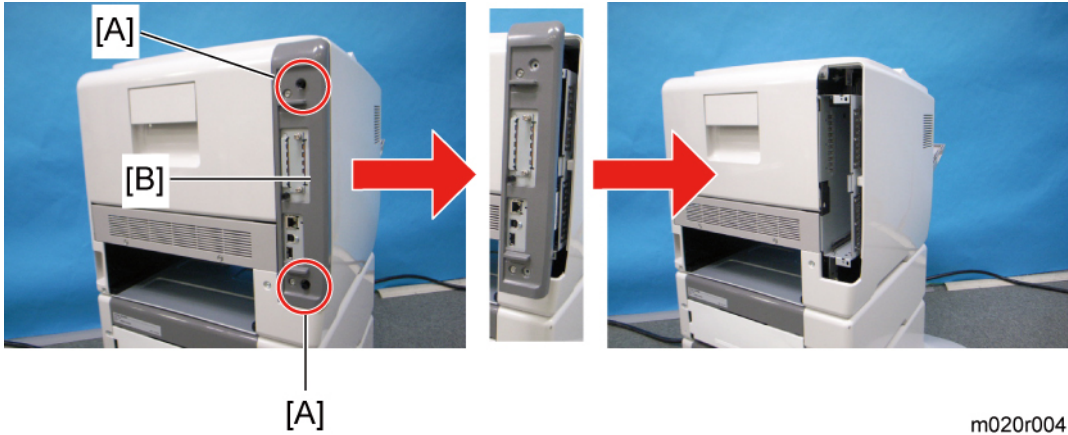

m020r004

1. Remove the controller board [B] (Knob screw x 2 [A]).

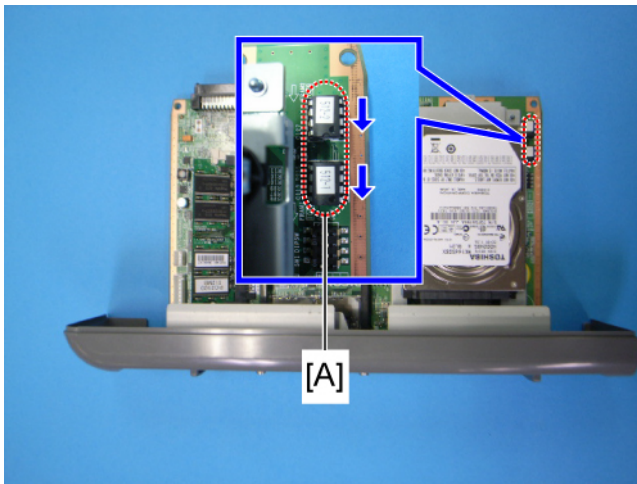

m020r042

2. Remove the 2 NVRAMs [A] if replacing the controller board.

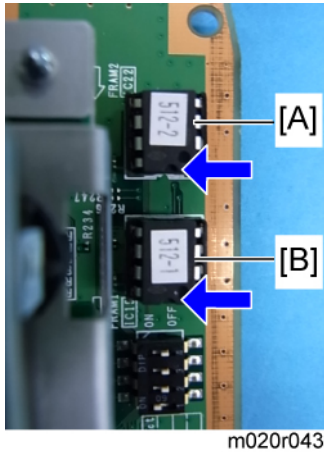

Note

- Remove NVRAMs from the old controller board and insert them on the new board. NVRAMs have an inserting direction. Orient the notches on the NVRAMs as shown by the arrows.
- Reinsert NVRAMs into the original position. Location [A] is for an NVRAM labeled "512-2" and location [B] is for an NVRAM labeled "512-1".
- The screws on the controller board are knob screws. Gently turn these screws when removing the controller board.
- Pull on the handle to remove the controller board from the machine.

Controller Box

1. Left cover (🔧 p.57)
2. Engine board with bracket (🔧 p.103)

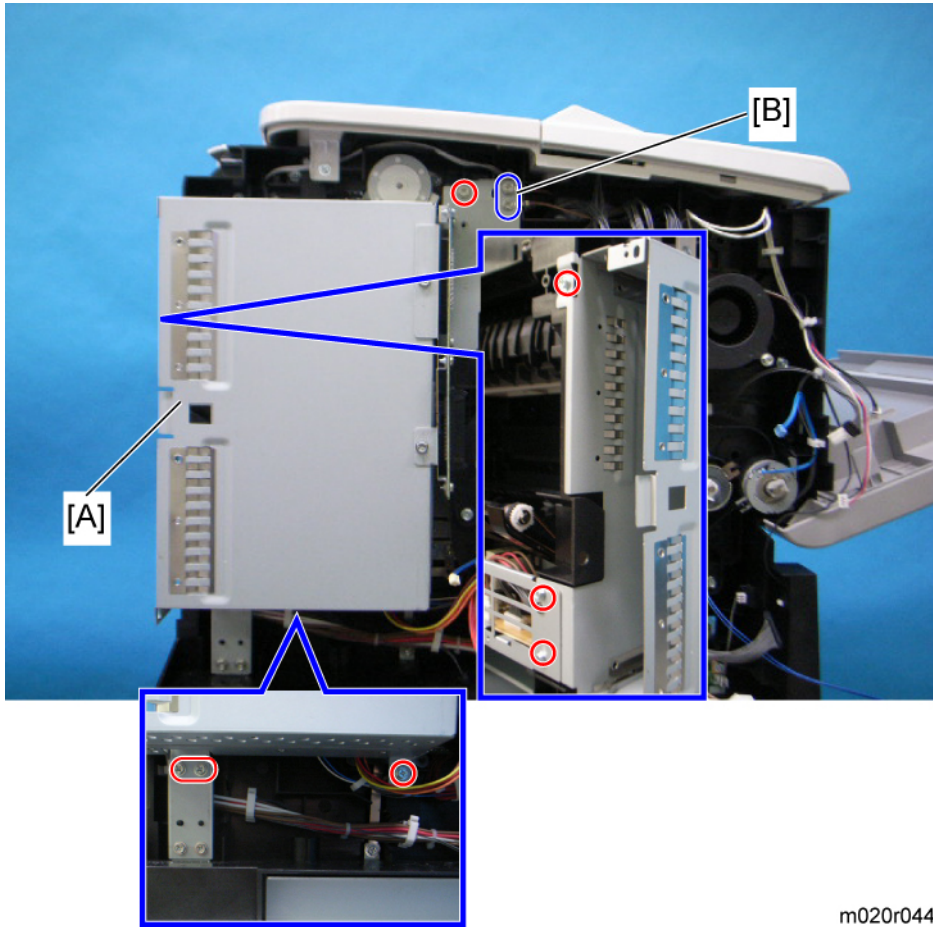





m020r044

3. Controller box [A] ( x 9).

Note

- Screws [B] are different from other seven screws.

PSU and PSU cover

1. Right cover ( p.56)
2. Fusing unit ( p.70)
3. Control Board unit ( p.57)
4. Rear Cover ( p.61)

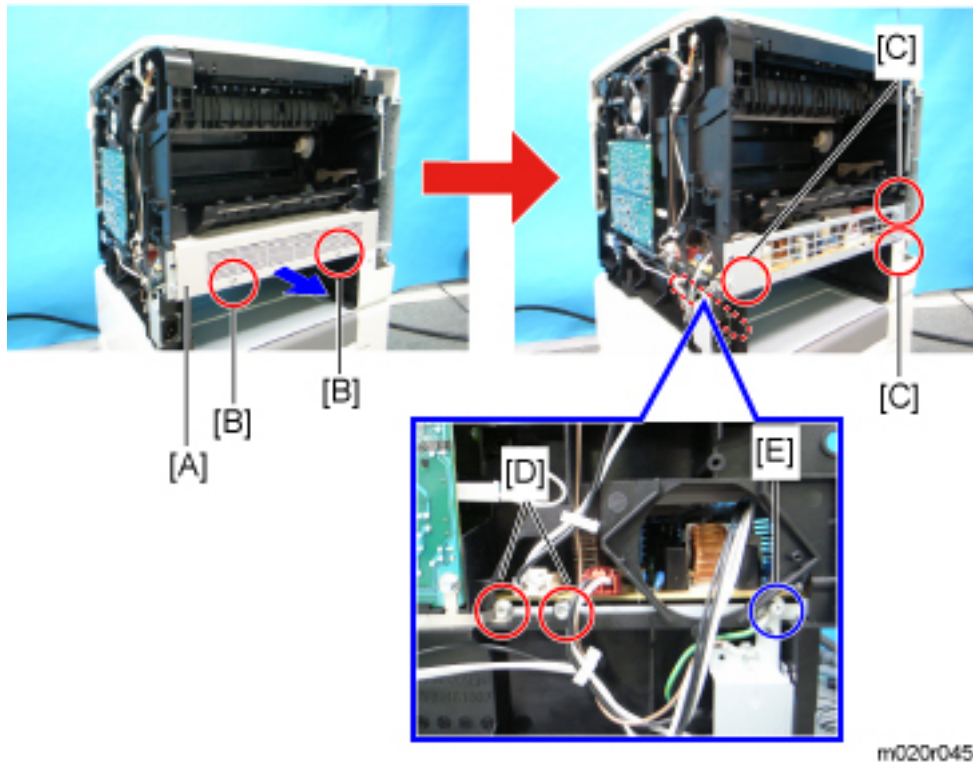

m020r045

5. PSU cover [A] ( x 2 [B]).

6. 6 screws [C], [D], [E].

Note

- One screw [E] is different from the other five screws.

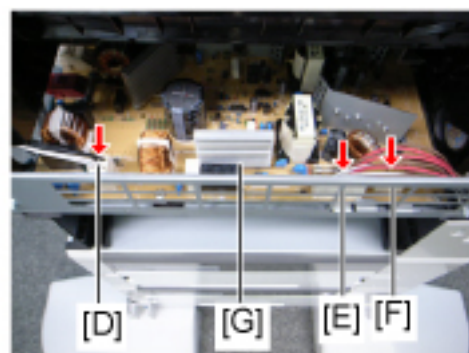
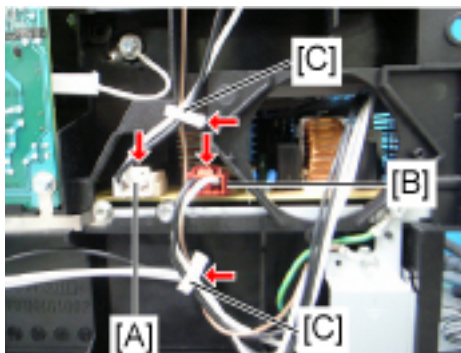

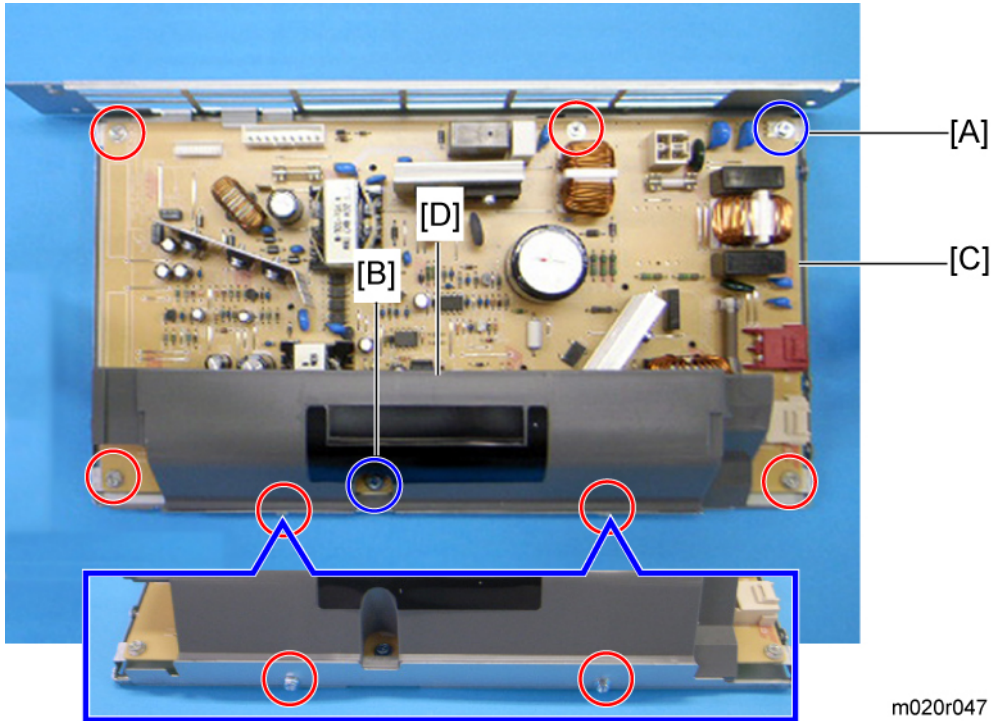

m020r046

7. PSU assembly [G] (All connectors [A], [B], [D], [E], [F],  x 2 [C]).



m020r047

8. PSU [C] ( x 6)
9. PSU protection cover [D] ( x 2).

Note

- Two screws [A], [B] are different from the other four screws.

Engine Board

1. Left cover ( p.57)

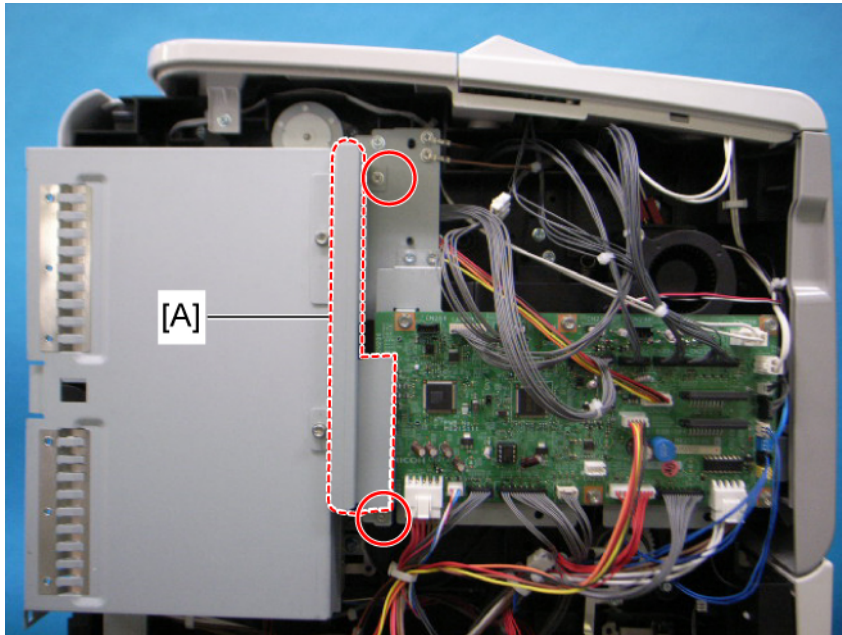

m020r048

2. Control unit connector cover [A] ( x 2).

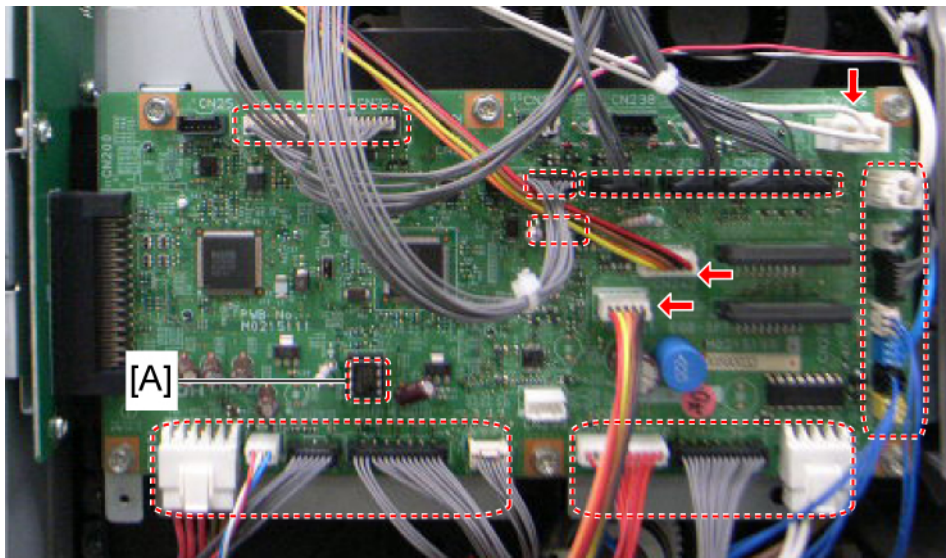

m020r049

3. Disconnect all connectors on the Engine board.
4. Open the front cover if closed.

★ Important

- When replacing the engine board, remove the EEPROM [A] from the old engine board and install it on the new board.

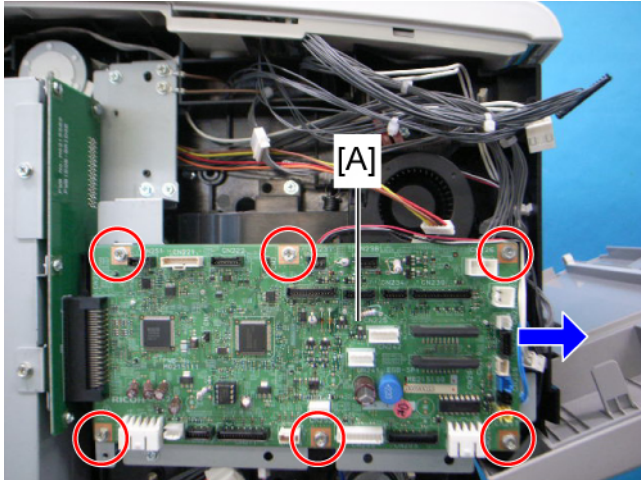

m020r050

5. Slide the engine board [A] in the direction indicated by the arrow and remove it ( x 6).

When installing a new engine board

1. Remove the EEPROM from the old engine board.
2. Install the EEPROM on the new engine board.
3. Reassemble the machine.
4. Turn on the main power of the machine.
5. "SC995-01" occurs.
6. Enter the SP mode, and then select SP5-811-004.
7. Enter the serial number with SP5-811-004, and then exit the SP mode.
8. Turn the main power of the machine off and on.

Note

- Make sure you print out the SMC reports ("SP Mode Data" and "Logging Data") before you replace the EEPROM.

CAUTION

- Keep the EEPROM away from any objects that can cause static electricity. Static electricity can damage EEPROM data.

Engine Board Bracket

1. Engine board ( p.100)

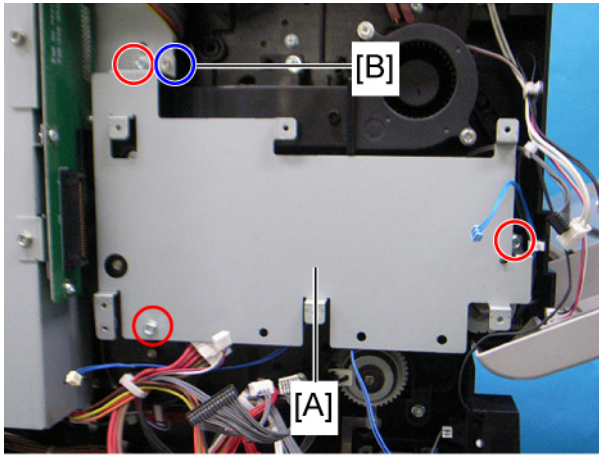

m020r051

2. Engine board bracket [A] ( x 4).

Note

- One screw [B] is different from the other three screws.

Engine Board with Bracket

1. Left cover ( p.57)

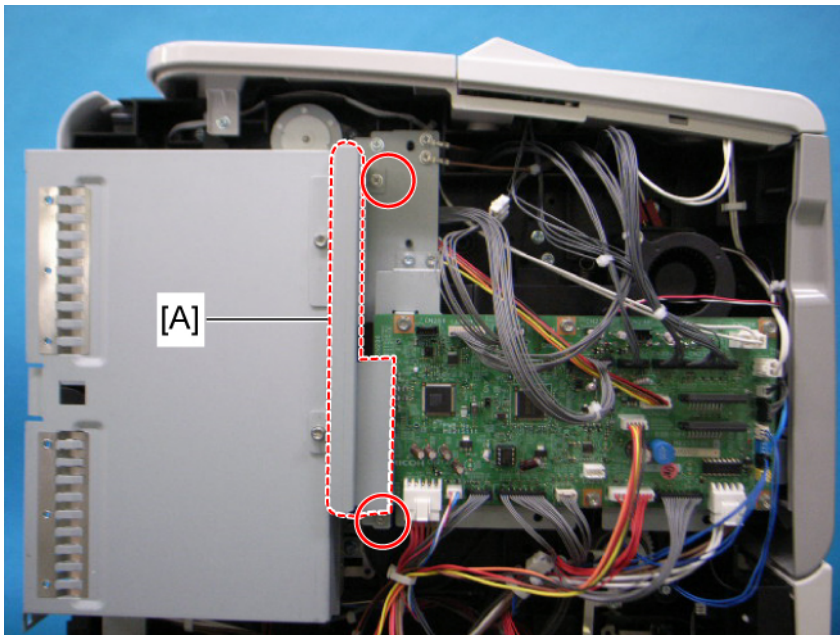

m020r048

2. Control unit connector cover [A] ( x 2)

4

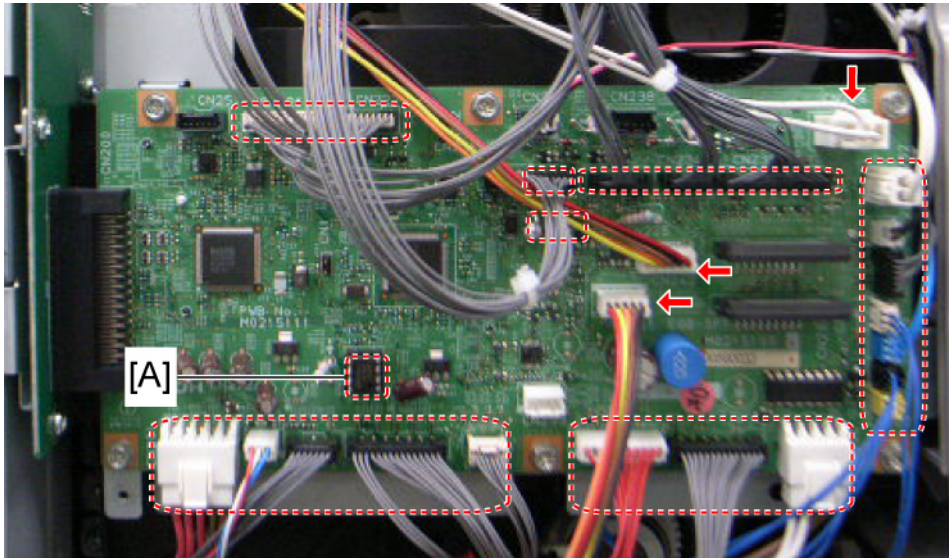

m020r049

3. Disconnect all connectors on the engine board.

★ Important

- When replacing the engine board, remove the EEPROM [A] from the old engine board and install it on the new board.

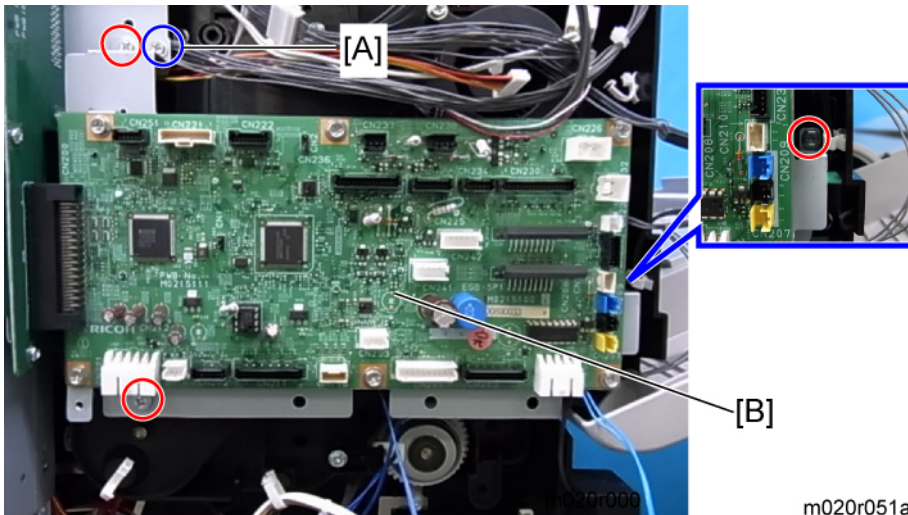

m020r051a

4. Engine board with bracket [B] (⚙ x 4).

↓ Note

- One screw [A] is different from the other 3 screws.

RFID (Radio Frequency ID)

1. Right cover (🔧 p.56)

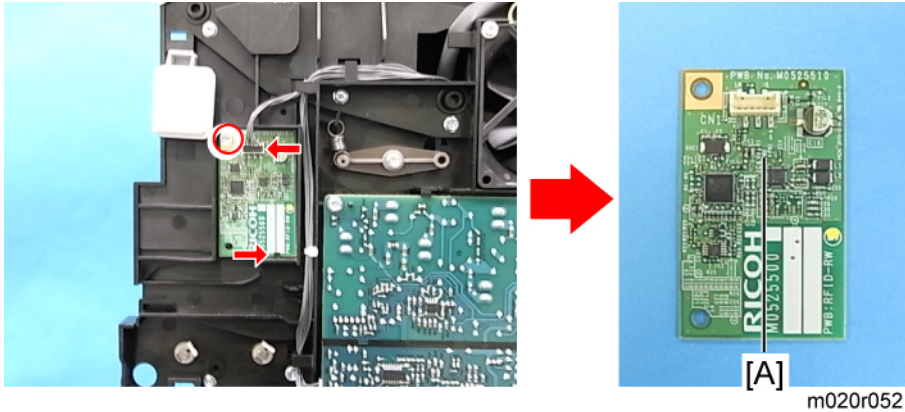

2. RFID [A] (🔧 x 1, 🔧 x 1, hook x 1).

HVPS (High Voltage Power Supply)

1. Right cover (🔧 p.56)

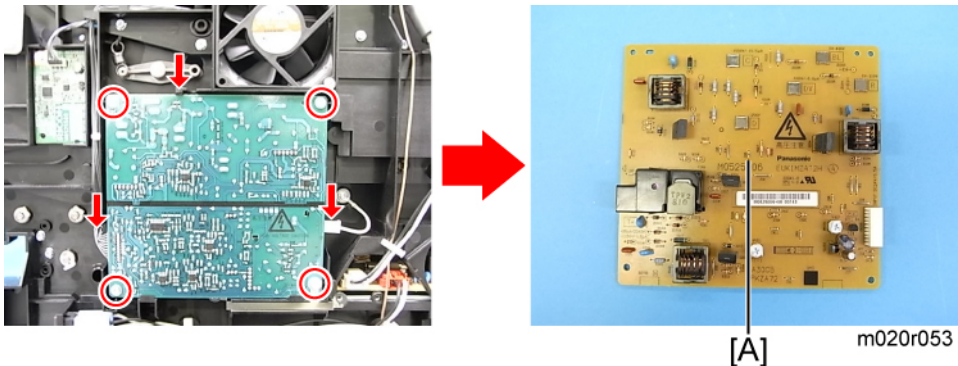

2. Remove the HVPS unit [A] (🔧 x 2, 🔧 x 4, hook x 1).

Operation Panel unit

Keyboard Unit

1. Operation panel (🔧 p.62)

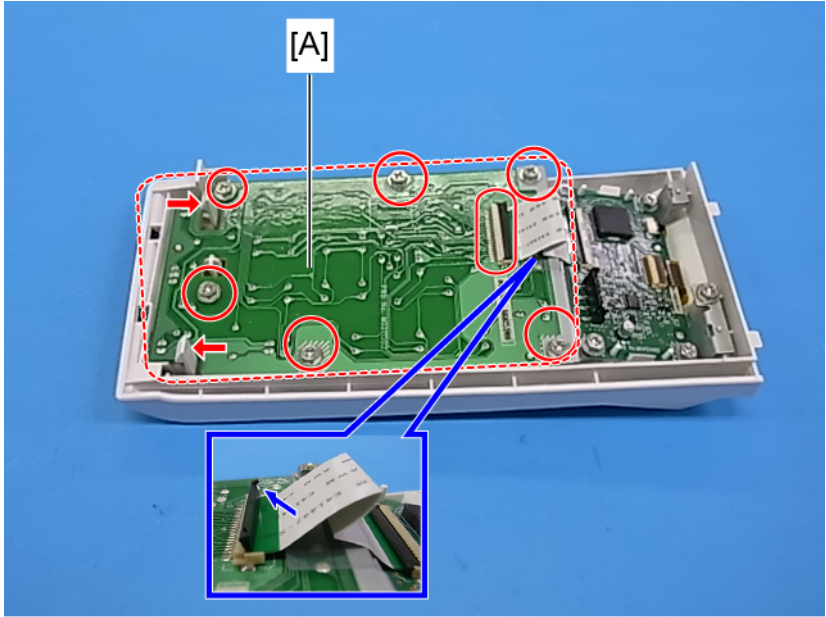

m020r054

2. Keyboard unit [A] (⌘ x 1, 🔧 x 6, hooks x 2).

Note

- Lift up the black tab on the connector to release the cable.
- The flat cable connector is very small and fragile. Take extra care when releasing it.

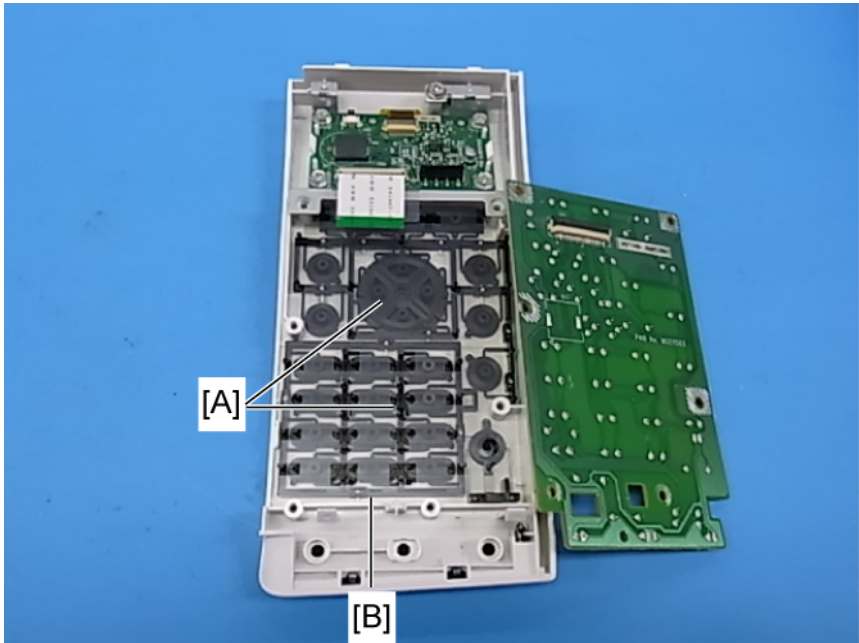

m020r055

3. Keys [A] and the insulation sheet [B] are now accessible.

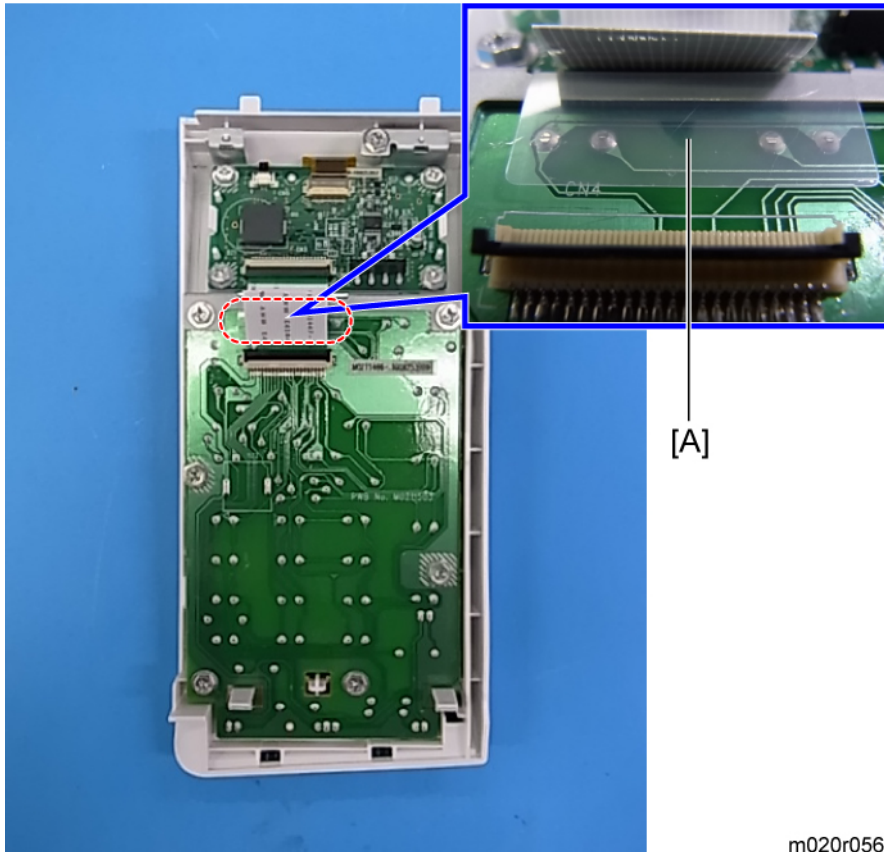

m020r056

↓ Note

- When reinstall the Keyboard unit:
- The insulation sheet [A] must be located between the flat cable and the keyboard unit.

Operation panel controller and LCD unit

1. Operation panel (📄 p.62)

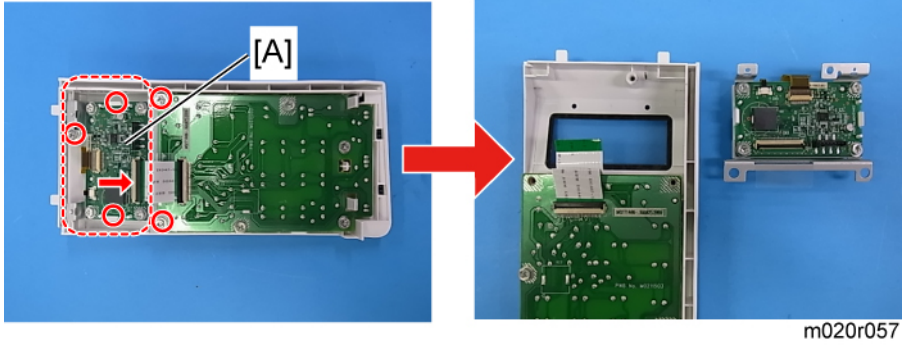

2. LCD assy [A] (🔧 x 1, 🔧 x 3, hooks x 2).

4

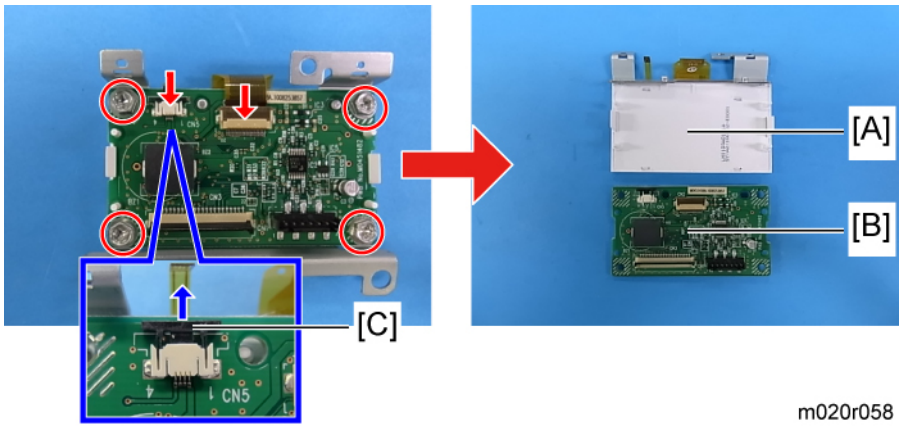

3. Remove the operation panel controller [B] from LCD unit [A] (🔧 x 2, 🔧 x 4).

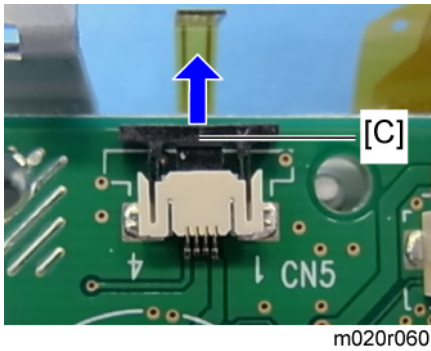

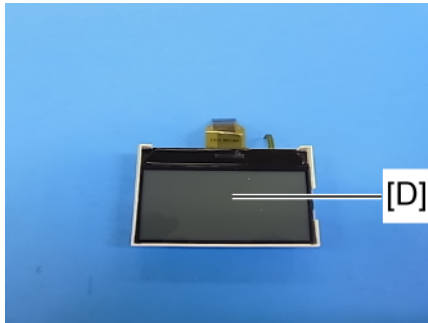

m020r059

↓ Note

- To release the left side flat cable, pull out the black tab [C] of the connector half way.
- Do not touch the LCD unit surface [D].

4

NVRAM and EEPROM

NVRAMs

1. Print the SMC data ("ALL") using SP5-990-001 (📄 p.138).
2. Turn off the main switch.
3. Remove the VM card from SD card Slot 2 (Lower).
4. Insert a blank SD card into Slot 2 (Lower), and then turn on the main power switch.
5. Upload the NVRAM data to the blank SD card using SP5-824-001 (📄 p.138, p.231).
6. Turn off the main power switch, and then unplug the AC power cord.
7. Remove the SD Card containing the NVRAM data from Slot 2 (Lower).
8. Replace the NVRAMs on the Controller Board with a new ones (📄 p.96).
9. Plug in the AC power cord, and then turn on the main power switch

★ Important

- When you do this, SC995-02 (Defective NVRAM) will be displayed. However, do not turn off the main power switch. Continue this procedure.

10. Re-insert the SD card that you removed in Step 7 back into Slot 2 (Lower)
11. Download the old NVRAM data from the SD card onto the new NVRAMs using SP5-825-001 (📄 p.232).

↓ Note

- This will take about 2 or 3 minutes.
12. Turn off the main power switch, and then remove the SD card from Slot 2 (Lower).

13. Insert the VM card into Slot 2 (Lower).
14. Turn on the main power switch.
15. Print the SMC data ("ALL") using SP5-990-001 (📄 p.138, and make sure that it matches the SMC data you printed out in Step 1 above (except for the value of the total counter).

↓ **Note**

- The value of the total counter is reset to "0" when the NVRAMs are replaced.

★ **Important**

- Do all of the following if SP5-824-001 (📄 p.231) and SP5-825-001 (📄 p.232) cannot be performed for some reason:
 - 1. Replace the NVRAMs and Security SD card together as a set with new ones.
 - 2. Manually enter all data on the SMC report (factory settings).
 - 3. Install the new Security SD card functions (Data overwrite and HDD encryption). See RTB #RGene039 for the procedure.

4

EEPROM

1. Make sure that you have the SMC report (factory settings). This report comes with the machine.
2. Output the SMC data (📄 SP5-990-001) if possible.
3. Turn the main switch off.
4. Install an SD card into SD card slot 2 (Lower). Then turn the main power on.
5. Copy the EEPROM data to an SD card (📄 SP5-824-001) if possible.
6. Turn off the main switch. Then unplug the power cord.
7. Replace the EEPROM on the engine board and reassemble the machine.
8. Plug in the power cord. Then turn the main switch on.
9. Select a paper-size type (📄 SP5-131-001).
10. Specify the serial number and destination code of the machine.

↓ **Note**

- Contact your supervisor for details on how to enter the serial number and destination code.
- SC 999 or "Fusing Unit Setting Error" will be shown until the serial number and destination code are correctly programmed.

11. Turn the main switch off and on.
12. Copy the data from the SD card to the EEPROM (📄 SP5-825-001) if you have successfully copied them to the SD card.
13. Turn the main switch off. Then remove the SD card from SD card slot 2 (Lower).
14. Turn the main switch on.

15. Specify the SP and UP mode settings.

★ Important

- If SP5-824-001 (EEPROM Data Upload) and SP5-825-001 (EEPROM Data Download) cannot be performed for some reason, manually enter all data on the SMC report (factory settings).

Switches

Tray Set Switch and Paper Size detection Sensor Board

1. Pull out the standard paper tray unit.
2. Left cover (🔧 p.57)

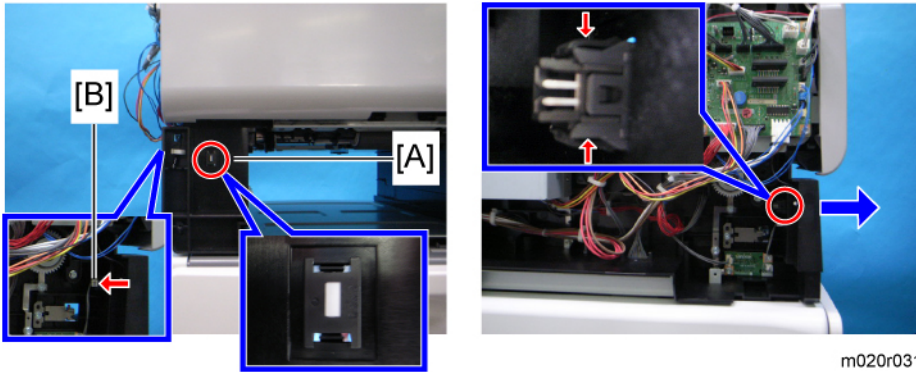

3. Release hooks and pull the tray set switch [A] out as indicated by the arrows (🔧 [B] x 1, hooks x 2).

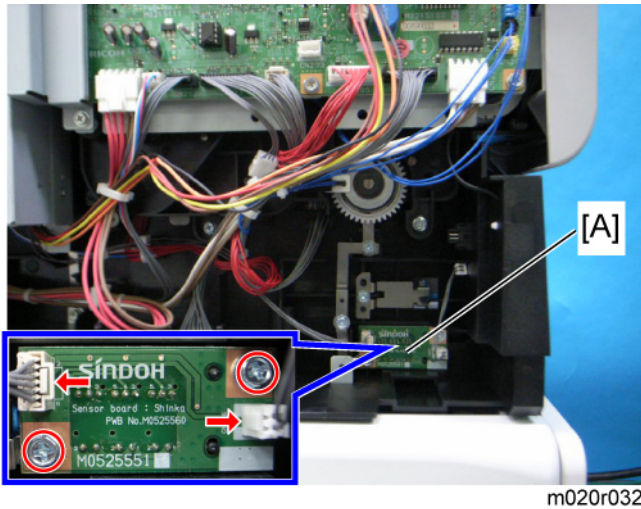

4. Paper size detection sensor board [A] (🔧 x 2, 🔧 x 2)

Rear-left Interlock switch

1. Right cover (🔧 p.56)
2. Left cover (🔧 p.56)

3. Upper cover (🔧 p.58)
4. Upper cover part (🔧 p.58)

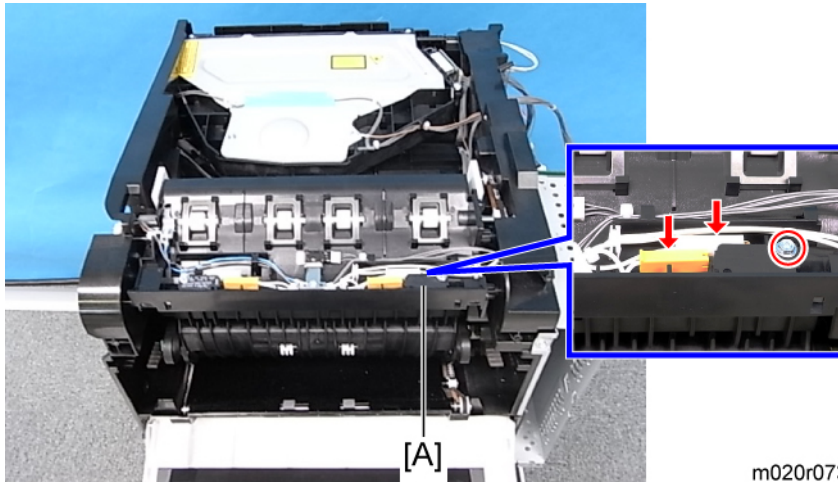

5. Rear-left interlock switch [A] (🔧 x 1, 📦 x 2).

Rear-right Interlock Switch

1. Right cover (🔧 p.56)
2. Left cover (🔧 p.57)
3. Upper cover (🔧 p.58)
4. Upper cover part (🔧 p.58)

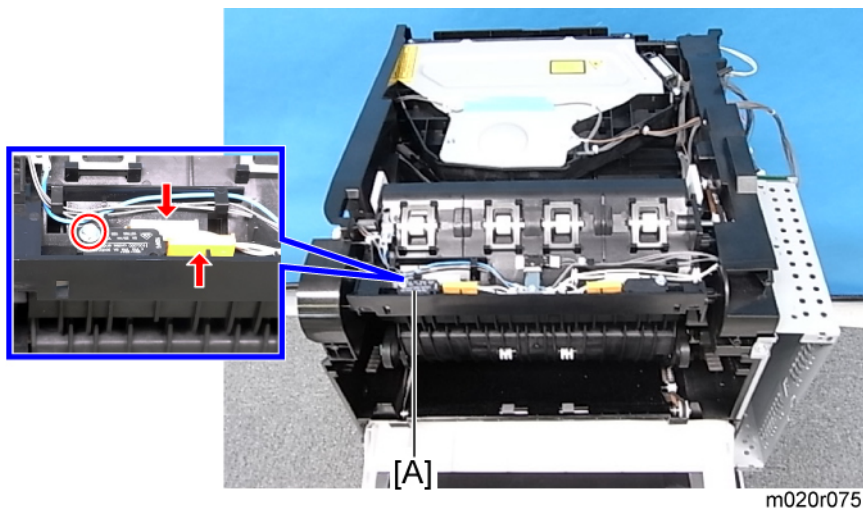

5. Rear-right interlock switch [A] (🔧 x 1, 📦 x 2).

Front Interlock Switch

1. Left cover (🔧 p.57)
2. Engine board with bracket (🔧 p.103)
3. AIO fan (🔧 p.118)

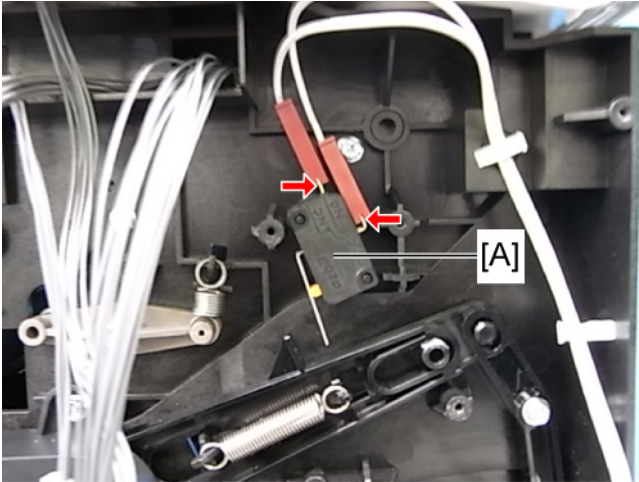

4. Duct [A] of the AIO fan (blower) (🔧 x 1).

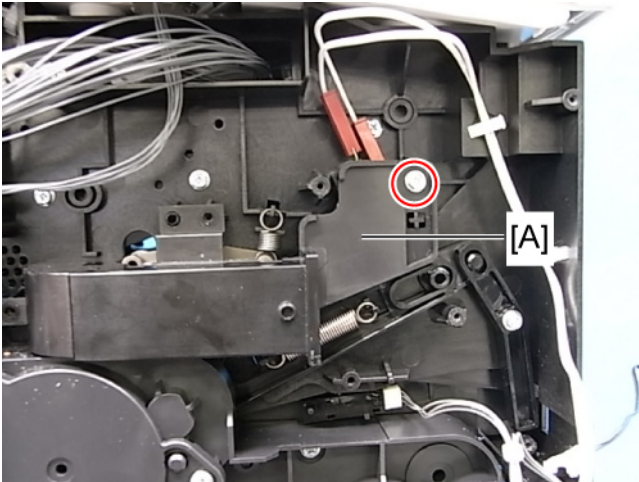

5. Front interlock switch [A] (🔧 x 2).

Clutches

Overview

There are 4 clutches on the machine as shown in the following photograph.

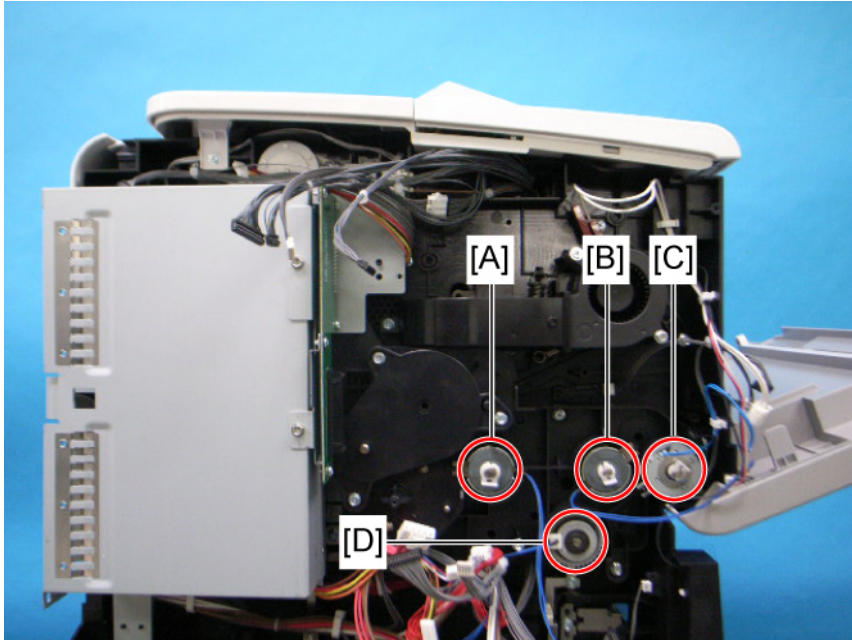

m020r078

[A]: Registration clutch

[B]: Relay clutch

[C]: By-pass feed clutch

[D]: Paper Feed clutch

Registration Clutch

1. Left cover (🔧 p.57)
2. Engine board with bracket (🔧 p.103)

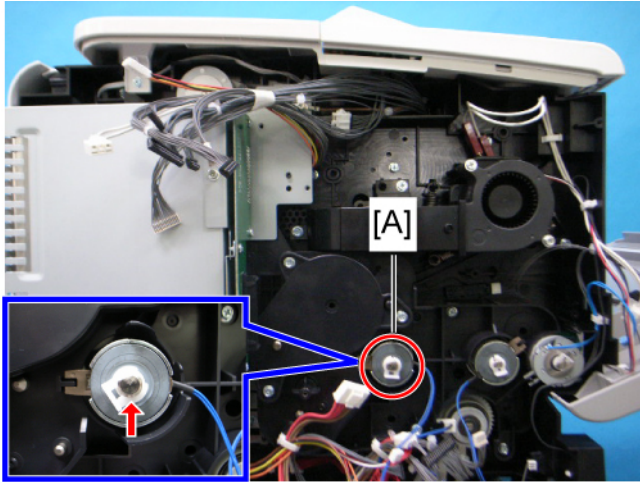

m020r079

3. Registration clutch [A] (☞ x 1).

Relay Clutch

1. Left cover (☞ p.57)
2. Engine board with bracket (☞ p.103)

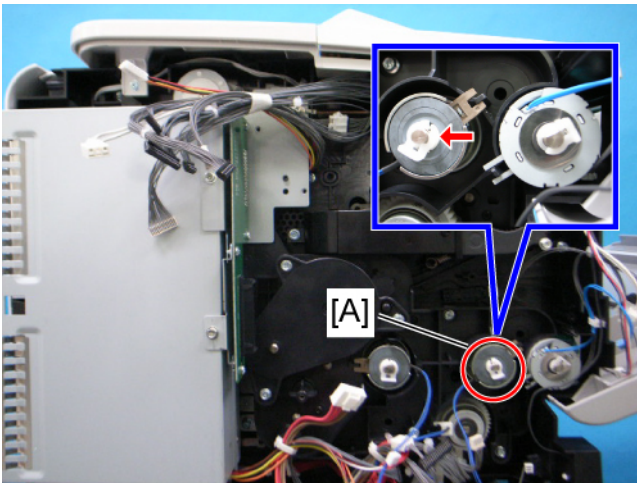

m020r080

3. Relay clutch [A] (☞ x 1).

By-pass Feed Clutch

1. Left cover (☞ p.57)

2. Engine board with bracket (🔧 p.103)

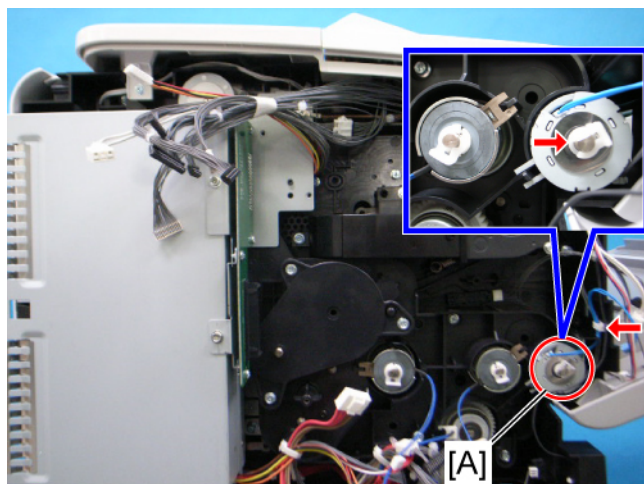

m020r081

3. By-pass feed clutch [C] (🔧 x 1, ⚙️ x 1).

↓ **Note**

- The by-pass feed clutch can rotate only one revolution. A forced rotation over one revolution may cause trouble.

Paper Feed Clutch

1. Left cover (🔧 p.57)
2. Engine board with bracket (🔧 p.103)

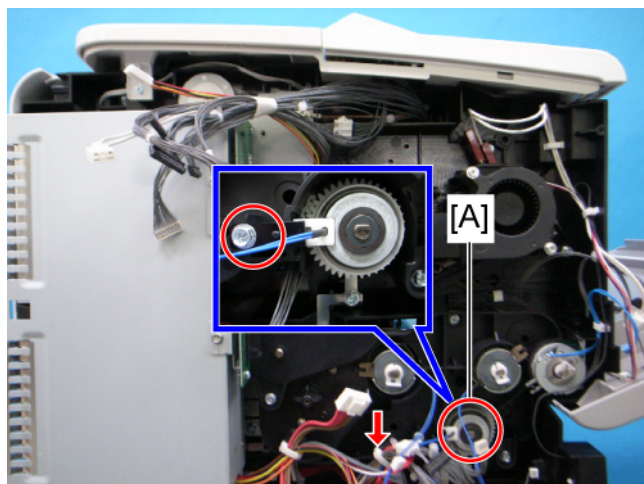

m020r083

3. Paper feed clutch [A] (🔧 x 1, ⚙️ x 1)

Fans

Overview

4

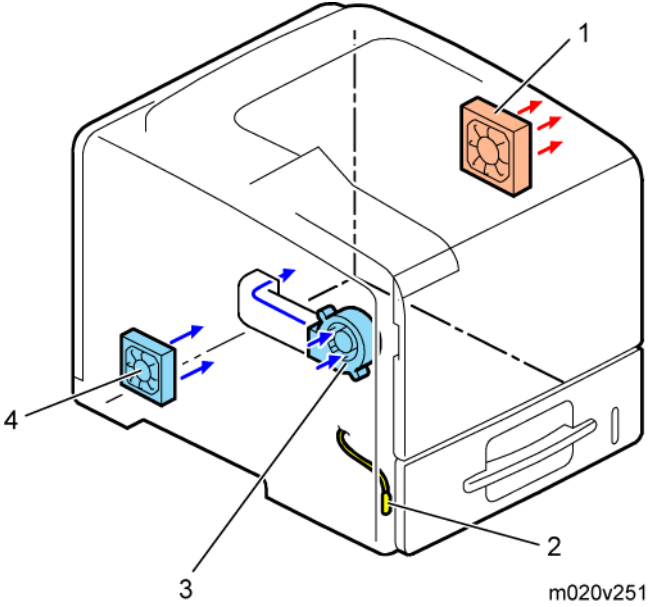

- 1. Exhaust fan
- 2. Transfer thermistor (temperature sensor)
- 3. AIO fan (Blower)
- 4. PSU fan

AIO Fan

- 1. Left cover (📄 p.57)
- 2. Engine board (📄 p.100)

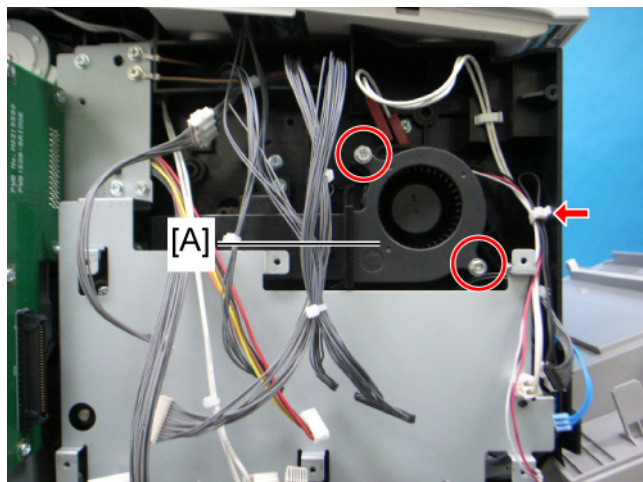

m020r084

3. AIO fan [A] (🔧 x 1, 🛠️ x 2).

↓ Note

- Make sure to mount the AIO fan properly. Otherwise, air will blow the wrong way.

Exhaust Fan

1. Right cover (🔧 p.56)

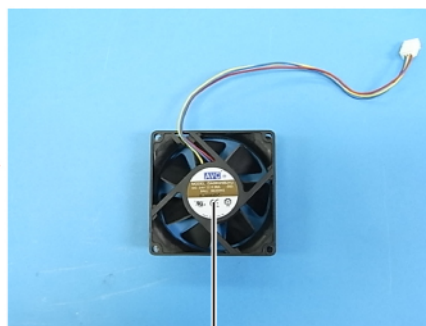
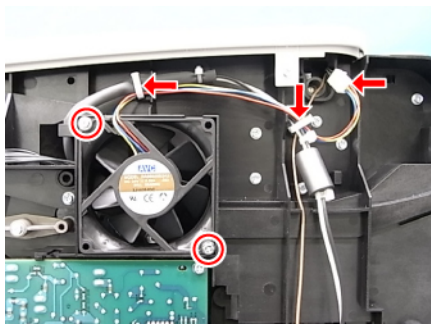

[A]

m020r085

2. Exhaust fan [A] (🔧 x 2, 🛠️ x 1, 🛠️ x 2).

PSU Fan

1. Left cover (🔧 p.57)
2. Engine board with bracket (🔧 p.103)

3. Controller box (🔧 p.97)

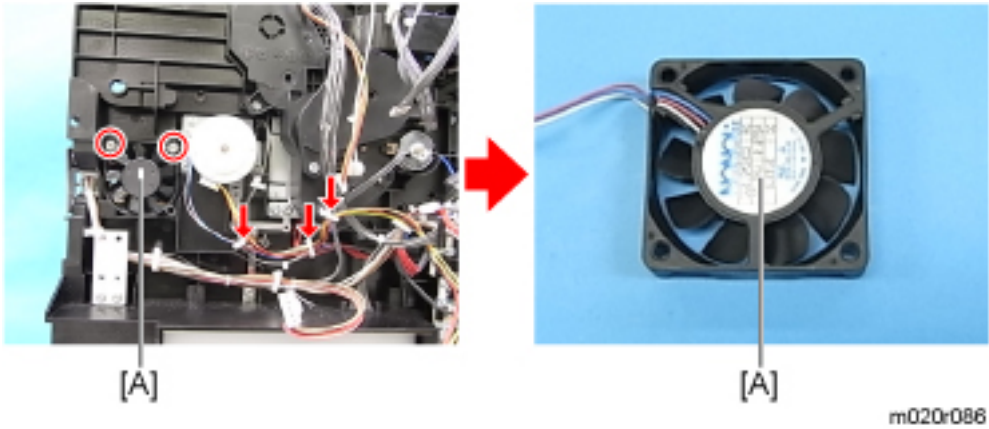

4

4. PSU fan [A] (🔧 x 2, 📦 x 1, 🔧 x 2).

Transfer Thermistor

1. Pull the standard paper tray out.
2. Left cover (🔧 p.57)

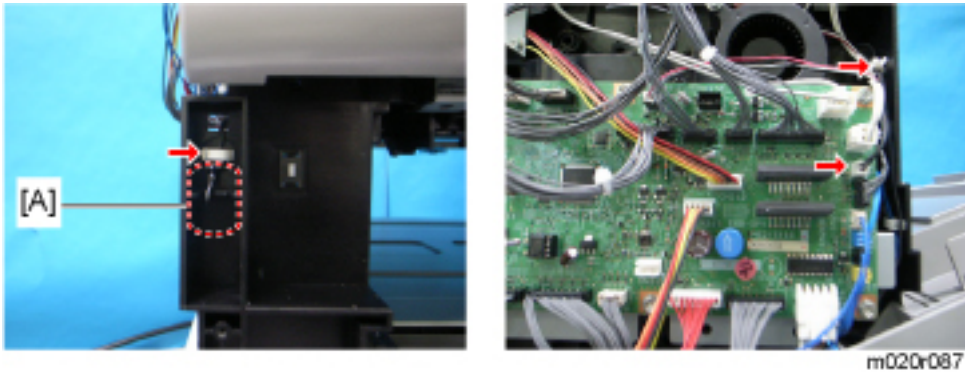

3. Transfer thermistor [A] (🔧 x 2, 📦 x 1).

Other Electrical Components

HDD (option for M020)

1. Controller board (📄 p.96)

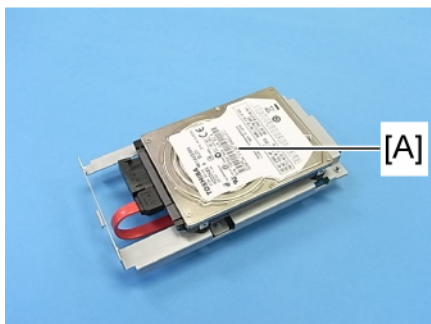
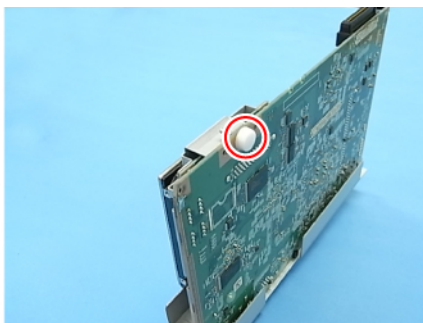

[A]

m020r088

2. HDD [A] (📄 x 3, 📄 x 1).

DIMM (option for M020)

1. Controller board (📄 p.96).

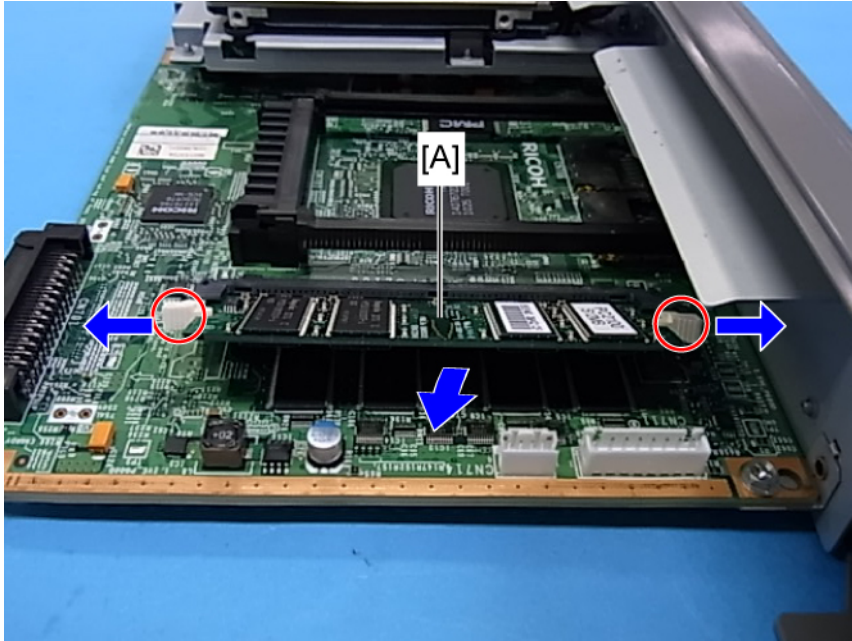

m020r089

2. Release 2 snaps and lift the DIMM [A] up, and then remove the DIMM [A].

★ Important

- Do not touch the contacts of DIMM. That could cause a bad contact.

Duplex Junction Solenoid

1. Left cover (🔧 p.57)
2. Engine board bracket (🔧 p.100)
3. Controller board box (🔧 p.97)

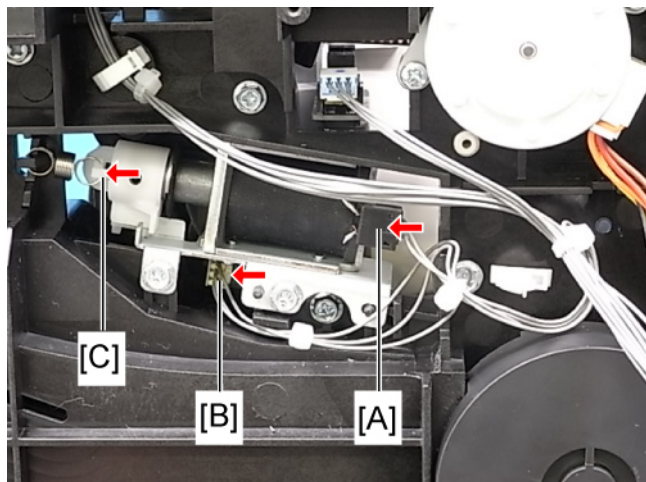

m020r090

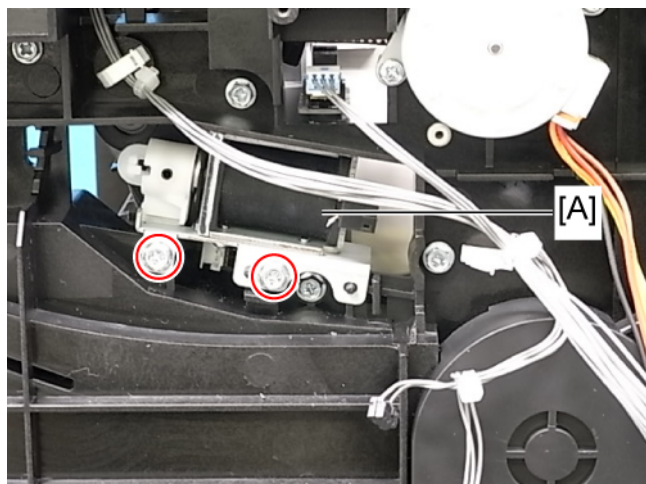

4. 2 connectors [A], [B] and the spring [C].



m020r091



5. Duplex junction solenoid [A] ( x 2).

Toner End Sensor

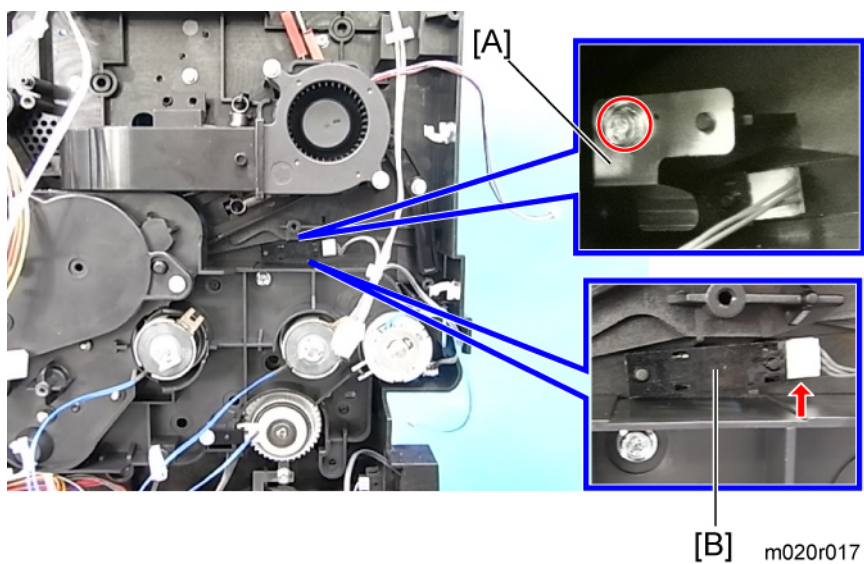
1. AIO unit.
2. Left cover ( p.57)
3. Engine board with bracket ( p.103)



4

4. Plate spring [A] ( x 1).
5. Toner end sensor [B] ( x 1).

Drive Section

Overview

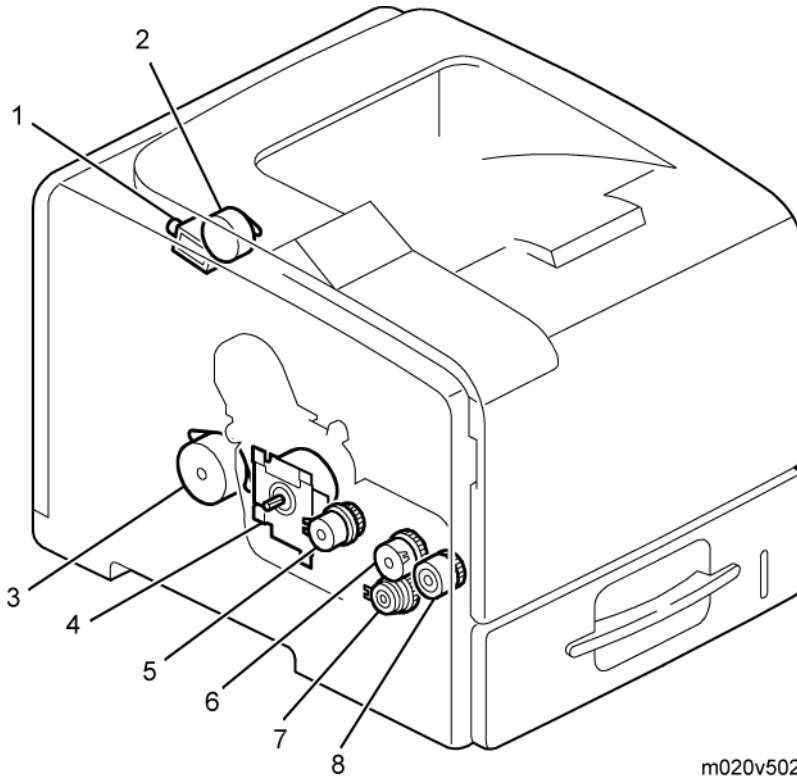

1. Duplex junction solenoid
2. Feed exit motor
3. Duplex motor
4. Main motor
5. Registration clutch
6. Relay clutch
7. Paper clutch
8. By-pass feed clutch

Main Motor Gear Assy

1. Left cover (p.57)

2. Engine board with bracket (🔧 p.103)
3. Controller box (🔧 p.97)
4. All clutches (🔧 p.115)
5. AIO fan and AIO fan duct (🔧 p.118, 🔧 p.114)

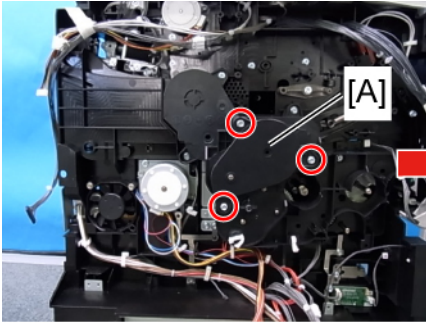

m020r061

6. Central gear assembly [A] (🔧 x 3).

★ Important

- Remove the central gear assembly gently to avoid popping the spring.

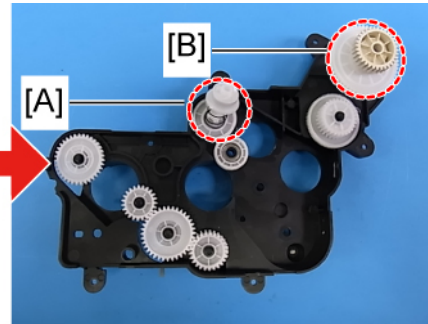
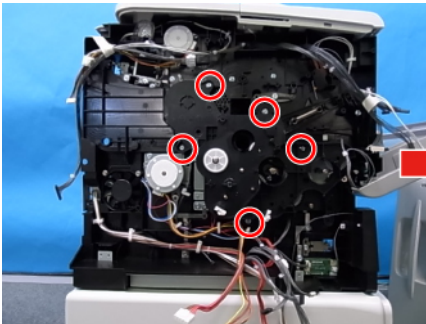

m020r062

7. Main motor gear assembly (🔧 x 5).

★ Important

- Gears [A], [B] contain springs. Take care as they can easily pop off.
- When reinstalling the gear assembly, hold gears [A] [B] with your hands to prevent them from dropping
- Reference the upper right photo when reassembling the gear unit.

Main Motor

1. Main motor gear assy (🔧 p.125)

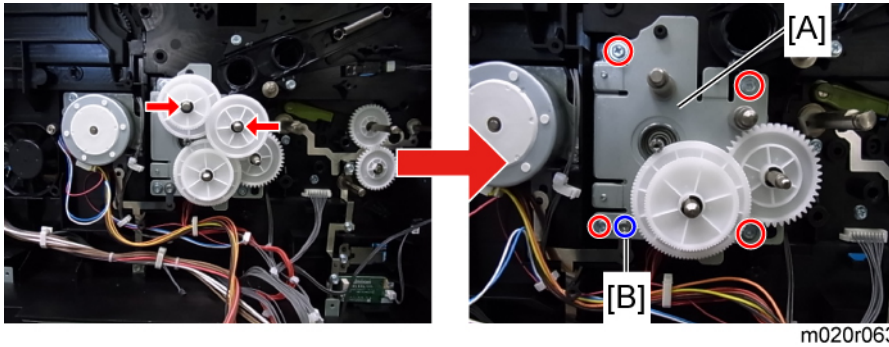

2. 2 gears (Ⓒ x 2).
3. Main motor assembly [A] (🔩 x 5).

↓ **Note**

- One screw [B] is different from the others.
- All connectors have already been disconnected when the engine board had been removed.

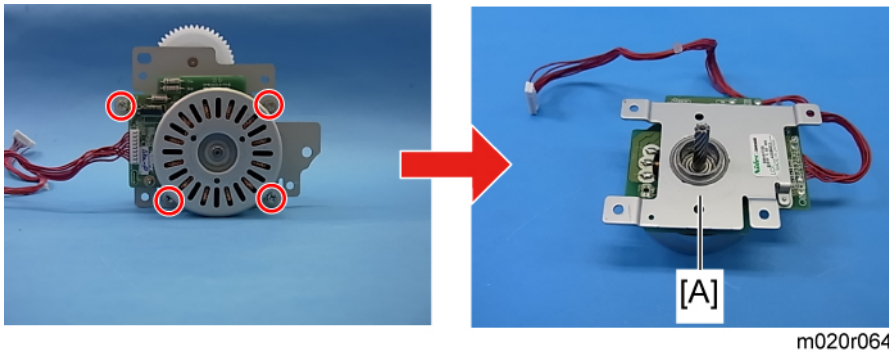

4. Main motor [A] (🔩 x 4).

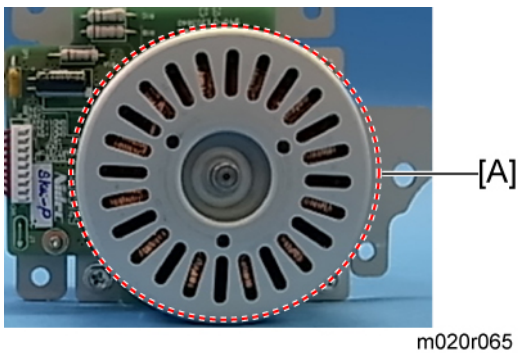

★ **Important**

- A protection seal is attached at [A] on the new main motor.
- Peel off this seal when replacing.

Paper Exit Motor

1. Left cover (p.57)
2. Upper cover (p.58)
3. Engine board with bracket (p.103)
4. Controller box (p.97)

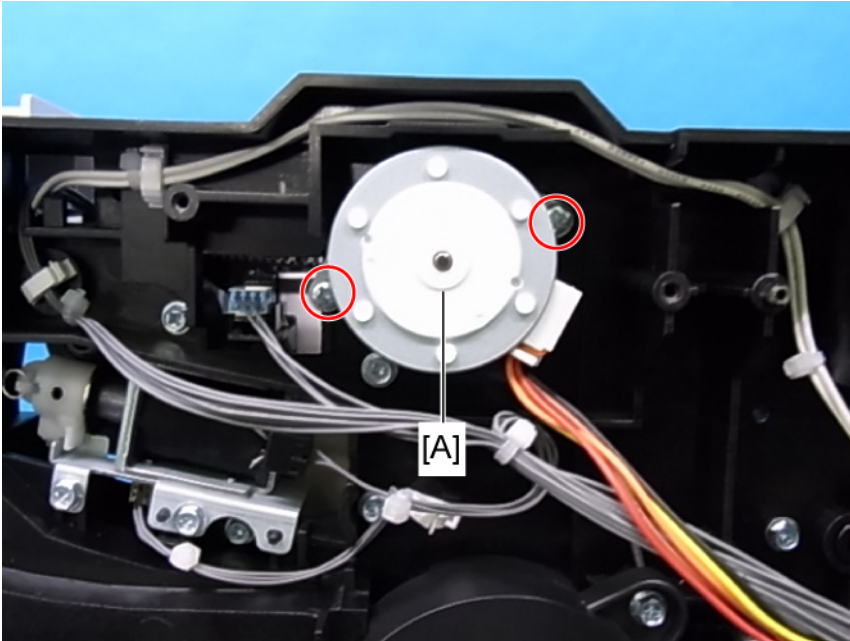

m020r066

5. Move the exit motor [A] forward slightly and remove it ( x 2).

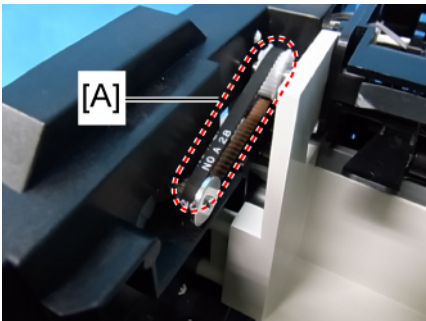

m020r067

6. Release the belt [A].

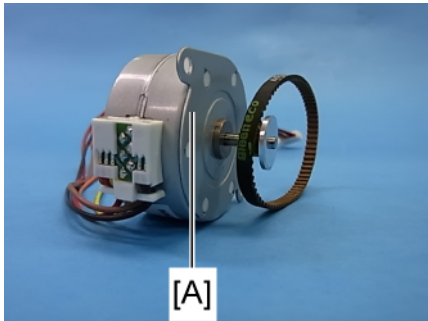

m020r068

7. Remove the paper exit motor [A].

Duplex motor

4

1. Left cover (🔧 p.57)
2. Engine board with bracket (🔧 p.103)
3. Controller box (🔧 p.97)
4. PSU fan (🔧 p.119)

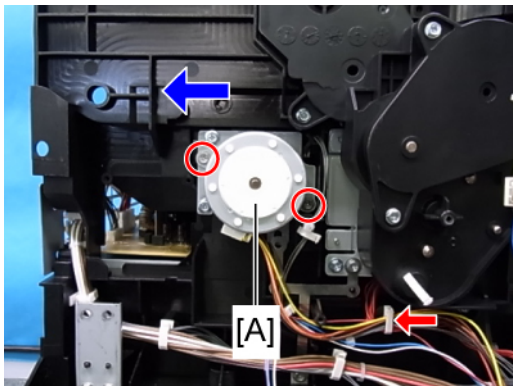

m020r069

5. Duplex motor [A] (🔧 x 1, 🔩 x 2).

⚠ Note

- Move the duplex motor to the left as shown by the arrow to remove it.
- (All connectors were disconnected when the engine board was removed.)

5. System Maintenance Reference

Printer Service Mode

SP1-XXX (Service Mode)

DFU: Denotes "Design or Factory Use". Do not change this value.

1001	Bit Switch			
001	Bit Switch 1		0	1
	bit 0	DFU	-	-
	bit 1	DFU	-	-
	bit 2	DFU	-	-
	bit 3	No I/O Timeout	0: Disable	1: Enable
		Enable: The MFP I/O Timeout setting will have no effect. I/O Timeouts will never occur.		
	bit 4	SD Card Save Mode	0: Disable	1: Enable
		Enable: Print jobs will be saved to an SD Card in the GW SD slot (see "Card Save Function" in "System Maintenance" chapter of the Field Service Manual).		
	bit 5	DFU	-	-
	bit 6	DFU	-	-
bit 7	[RPCS,PCL]: Printable area frame border	0: Disable	1: Enable	
	Enable: The machine prints all RPCS and PCL jobs with a border on the edges of the printable area.			
1001	Bit Switch			

002	Bit Switch 2		0	1
	bit 0	DFU	-	-
	bit 1	DFU	-	-
	bit 2	DFU	-	-
	bit 3	[PCL5e/c,PS]: PDL Auto Switching	0: Enable	1: Disable
		Disable: Disables the ability to change the PDL processor mid-job. Some host systems submit jobs that contain both PS and PCL5e/c. If Auto PDL switching is disabled, these jobs will not be printed properly.		
	bit 4	DFU	-	-
	bit 5	DFU	-	-
	bit 6	DFU	-	-
bit 7	DFU	-	-	

1001	Bit Switch			
003	Bit Switch 3		0	1
	bit 0	DFU	-	-
	bit 1	DFU	-	-
	bit 2	[PCL5e/c]: Legacy HP compatibility	0: Disable	1: Enable
		Enable: Uses the same left margin as older HP models such as HP4000/HP8000. In other words, the left margin defined in the job (usually "<ESC>*r0A") will be changed to "<ESC>*r1A"		
	bit 3	DFU	-	-
	bit 4	DFU	-	-
	bit 5	DFU	-	-
	bit 6	DFU	-	-
bit 7	DFU	-	-	

1001	Bit Switch		
------	------------	--	--

004	Bit Switch 4		0	1
	bit 0	DFU	-	-
	bit 1	DFU	-	-
	bit 2	DFU	-	-
	bit 3	IPDS print-side reversal	Disabled	Enabled
		If this bit switch is enabled, the simplex pages of IPDS jobs will be printed on the front side because of printing on the back side of the page. This might reduce printing speed.		
	bit 4	DFU	-	-
	bit 5	DFU	-	-
	bit 6	DFU	-	-
bit 7	DFU	-	-	

1001	Bit Switch			
005	Bit Switch 5		0	1
	bit 0	DFU	-	-
	bit 1	Multiple copies if a paper size or type mismatch occurs	0: Disable (Single copy)	1: Enable (Multiple copy)
		If a paper size or type mismatch occurs during the printing of multiple copies, only a single copy is output by default. Using this BitSw, the device can be configured to print all copies even if a paper mismatch occurs.		
	bit 2	Prevent SDK applications from altering the contents of a job.	Disabled	Enabled
		<p>If this BitSw is enabled, SDK applications will not be able to alter print data. This is achieved by preventing SDK applications from accessing a module called the "GPS Filter".</p> <p>Note</p> <ul style="list-style-type: none"> The main purpose of this BitSw is for troubleshooting the effects of SDK applications on data. 		

5

	bit 3	[PS] PS Criteria	Pattern3	Pattern1
		Change the number of PS criterion used by the PS interpreter to determine whether a job is PS data or not. Pattern3: includes most PS commands. Pattern 1 : A small number of PS tags and headers		
	bit 4	Increase max number of the stored jobs to 1000 jobs.	Disable (100)	Enable (1000)
		Enable: Changes the maximum number of jobs that can be stored on the HDD via Job Type settings to 1000. The default is 100.		
	bit 5	Face-up output	Disable	Enable
		Enable: All print jobs will be output face-up in the destination tray.		
	bit 6	Method for determining the image rotation for the edge to bind on.	0: Disable	1: Enable
		If enabled, the image rotation will be performed as in the specifications of older models for the binding of pages of mixed orientation jobs. The old models are below: - PCL: Pre-04A models - PS/PDF/RPCS:Pre-05S models		
	bit 7	Letterhead mode printing	0: Disable	1: Enable (Duplex)

1001	Bit Switch		
006	Bit Switch 6 DFU	-	-

1001	Bit Switch			
007	Bit Switch 7	0	1	
	bit 0	Print path	0: Disable	1: Enable
		If enabled, simplex pages (in mixed simplex/duplex PS/PCL5 jobs only) and the last page of an odd paged duplex job (PS, PCL5, PCL6), are always routed through the duplex unit. Not having to switch paper paths increases the print speed slightly.		

	bit 1	DFU	-	-
	bit 2	DFU		
	bit 3	DFU		
	bit 4	DFU		
	bit 5	DFU		
	bit 7	DFU		

1001	Bit Switch			
008	Bit Switch 8		0	1
	bit 0	DFU	-	-
	bit 1	DFU	-	-
	bit 2	DFU	-	-
	bit 3	DFU		
	bit 4	DFU	-	-
	bit 5	DFU	-	-
	bit 6	DFU	-	-
	bit 7	DFU	-	-

1001	Bit Switch			
009	Bit Switch 9		0	1
	bit 0	PDL Auto Detection timeout of jobs submitted via USB or Parallel Port (IEEE 1284).	"Disabled (Immediately)"	"Enabled (10 seconds)"
		To be used if PDL auto-detection fails. A failure of PDL autodetection doesn't necessarily mean that the job can't be printed. This bit switch tells the device whether to time-out immediately (default) upon failure or to wait 10 seconds.		
	bit 1	DFU	-	-

	bit 2	Job Cancel	Disabled (Not cancelled)	Enabled (Cancelled)
		<p>If this bit switch is enabled, all jobs will be cancelled after a jam occurs.</p> <p>Note: If this bitsw is enabled, printing under the following conditions might result in problems:</p> <ul style="list-style-type: none"> - Job submission via USB or Parallel Port - Spool printing (WIM >Configuration > Device Settings > System) 		
	bit 3	DFU	-	-
	bit 4	Timing of the PJJ Status ReadBack (JOB END) when printing multiple collated copies.	Disabled	Enabled
		<p>This bitsw determines the timing of the PJJ USTATUS JOB END sent when multiple collated copies are being printed.</p> <p>0 (default): JOB END is sent by the device to the client after the first copy has completed printing. This causes the page counter to be incremented after the first copy and then again at the end of the job.</p> <p>1: JOB END is sent by the device to the client after the last copy has finished printing. This causes the page counter to be incremented at the end of each job.</p>		
	bit 5	DFU	-	-
	bit 6	DFU	-	-
	bit 7	DFU	-	-

1003	[Clear Setting]
1003 001	Initialize System
	Initializes settings in the "System" menu of the user mode.
1003 003	Delete Program

1004	[Print Summary]
1004 001	Service Summary
	Prints the service summary sheet (a summary of all the controller settings).

1005	[Display Version]		
1005 001	Printer Version		
	Displays the version of the controller firmware.		
1007	[Supply Display]		
	Enables or disables the display for information on each supply.		
1007 006	Fuser	*CTL	[0 or 1 / 0 / -] 0: OFF 1: ON

Engine Service Mode

Engine Mode Table

Notation	What it means
[range/default/step]	Example: [-9 to +9 / +3.0 / 0.1 mm step]. The setting can be adjusted in the range ± 9 , value reset to +3.0 after an NVRAM reset, and the value can be changed in 0.1 mm steps with each key press.
DFU	Denotes "Design or Factory Use". Do not change this value.

5

SP1-xxx: Feed

	Lead Edge Reg.	Leading Edge Registration
1001	Adjusts the printing leading edge registration for feeding from the trays and duplex tray using the trimming area pattern (SP5-902-003 No.14). Push [▲] or [▼] to select the settings (plus or minus). The specification is 4 ± 2 mm	

1001 001	By-pass: Plain	[-5.0 to +5.0 / 0.0 / 0.1]
1001 002	By-pass: Thick1	
1001 003	By-pass: Thick2	
1001 004	By-pass: Thick3	
1001 005	By-pass: Thin	
1001 006	Tray1: Plain	
1001 007	Tray1: Thick1	
1001 008	Tray1: Thick2	
1001 009	Tray1: Thick3	
1001 010	Tray1: Thin	
1001 011	Tray2: Plain	
1001 012	Tray2: Thick1	
1001 013	Tray2: Thick2	
1001 014	Tray2: Thick3	
1001 015	Tray2: Thin	
1001 016	Tray3: Plain	

5

1001 017	Tray3: Thick1	[-5.0 to +5.0 / 0.0 / 0.1]
1001 018	Tray3: Thick2	
1001 019	Tray3: Thick3	
1001 020	Tray3: Thin	
1001 021	Tray4: Plain	
1001 022	Tray4: Thick1	
1001 023	Tray4: Thick2	
1001 024	Tray4: Thick3	
1001 025	Tray4: Thin	
1001 026	Duplex: Plain	
1001 027	Duplex:Thick1	
1001 028	Duplex:Thick2	
1001 029	Tray5: Plain	
1001 030	Tray5: Thick1	
1001 031	Tray5: Thick2	
1001 032	Tray5: Thick3	
1001 033	Tray5: Thin	

	Side to Side Reg.	Side-to-Side Registration
1002	<p>Adjusts the printing side-to-side registration from the 1st paper feed station using the trimming area pattern (SP2-902-003 No.14).</p> <p>Push [▲] or [▼] to select the settings (plus or minus).</p> <p>Specification: 0 +/-2.0 mm.</p>	

1002 001	By-pass	[-5.0 to +5.0 / 0.0 / 0.1 mm]
1002 002	Tray1	
1002 003	Tray2	
1002 004	Tray3	
1002 005	Tray4	
1002 006	Duplex	
1002 007	Tray5	

1003	Regist Buckle	Registration Buckle Adjustment
	Adjusts the relay clutch timing at registration. Relay clutch timing determines the amount of paper buckle at registration. (A "+" setting causes more buckling.)	

5

1003 001	By-pass: Plain	[-7.0 to +7.0 / 0.0 / 0.1 mm]
1003 002	By-pass: Thick1	
1003 003	By-pass: Thick2	
1003 004	By-pass: Thick3	
1003 005	By-pass: Thin	
1003 006	Tray1: Plain	
1003 007	Tray1: Thick1	
1003 008	Tray1: Thick2	
1003 009	Tray1: Thick3	
1003 010	Tray1: Thin	
1003 011	Tray2: Plain	
1003 012	Tray2: Thick1	
1003 013	Tray2: Thick2	
1003 014	Tray2: Thick3	
1003 015	Tray2: Thin	
1003 016	Tray3: Plain	

1003 017	Tray3: Thick1	[-7.0 to +7.0 / 0.0 / 0.1 mm]
1003 018	Tray3: Thick2	
1003 019	Tray3: Thick3	
1003 020	Tray3: Thin	
1003 021	Tray4: Plain	
1003 022	Tray4: Thick1	
1003 023	Tray4: Thick2	
1003 024	Tray4: Thick3	
1003 025	Tray4: Thin	
1003 026	Duplex: Plain	
1003 027	Duplex: Thick1	
1003 028	Duplex: Thick2	
1003 029	Tray5: Plain	
1003 030	Tray5: Thick1	
1003 031	Tray5: Thick2	
1003 032	Tray5: Thick3	
1003 033	Tray5: Thin	

1103	PreRotate Temp	PreRotate Temperature Adjustment
1103 001	PreRotate Temp	Adjusts the prerotate temperature at the Fusing roller. Push [▲] or [▼] to select the settings (plus or minus). [0 to 180 / 135 / 1 deg.]

1105	Fusing Temp DFU	
	Adjusts the fusing temperatures for printing and standby mode.	
1105 001	Reload Temp	Adjusts the fusing temperature for reloading. [100 to 180 / 135 / 1 deg.]

1105 002	Stand-by Temp	Adjusts the fusing temperature for standby mode. [140 to 205 / 175 / 1 deg.]
1105 010	Print: Plain	Adjusts the fusing temperature for printing Plain paper. [150 to 215 / 200 / 5 deg.]
1105 011	Print: Thin	Adjusts the fusing temperature for printing Thin paper. [150 to 215 / 170 / 5 deg.]
1105 012	Print: Thick	Adjusts the fusing temperature for printing Thick paper. [150 to 215 / 195 / 5 deg.]
1105 013	Print: Small Size	Adjusts the fusing temperature for printing small size paper. [150 to 215 / 190 / 5 deg.]
1105 100	Ready: LL	Adjusts the fusing temperature for standby mode after reloading (LL). [140 to 205 / 200 / 1 deg.]
1105 101	Ready: MM	Adjusts the fusing temperature for standby mode after reloading (MM). [140 to 205 / 200 / 1 deg.]
1105 102	Ready: HH	Adjusts the fusing temperature for standby mode after reloading (HH). [140 to 205 / 195 / 1 deg.]
1105 103	Ready: T AL	Adjusts the fusing temperature for standby mode (AL). [150 to 215 / 190 / 5 deg.]
1105 104	Ready: T AM	Adjusts the fusing temperature for standby mode (AM). [150 to 215 / 195 / 5 deg.]
1105 105	Ready: T AH	Adjusts the fusing temperature for standby mode (AH). [150 to 215 / 190 / 5 deg.]
1159	Fusing Jam	Fusing Jam SC Detection

1159 001	SC Detection	Disables or enables the consecutive jam error for the fusing unit. [0 to 1 / 0 / 1] When set to "1" (on), this SC code is issued after the 3rd consecutive jam in the fusing unit.
----------	--------------	--

1902	OHP Clutch Rotate	OHP Clutch Rotations
1902 001	OHP Clutch Rotate	Selects the number of rotations for the bypass feed roller when the paper type is set for "Transparencies". Change this setting to "2" if jams occur frequently when feeding transparencies from the bypass tray. [1 to 2 / 1 / 1] 1 = 1 rotation, 2 = 2 rotations

1953	Switch FAN Ctrl. DFU	- RTB 26 - SP1953 defined in more detail
1953 001	Main FAN	[0 to 1 / 1 / 1]

SP2-xxx: Drum

2001	Charge Voltage DFU	Charge Roller Bias setting
2001 001	Charge Voltage	Adjusts the voltage applied to the charge roller for printing. [1000 to 2000 / 1550 / 1 V]

2103	Erase Mag Adjust	Adjust the erase margin by deleting image data at the margins.
2103 001	Lead Edge Width	[0 to 9.9 / 2.0 / 0.1 mm/ step]
2103 002	Trail. Edge Width	[0 to 9.9 / 4.0 / 0.1 mm/ step]
2103 003	Left	[0 to 9.9 / 2.0 / 0.1 mm/ step]
2103 004	Right	[0 to 9.9 / 2.0 / 0.1 mm/ step]

2112	Main-scan Mag.	Main Scan Magnification
------	----------------	-------------------------

2112 001	Main-scan Mag.	Adjusts the main scan magnification. [-0.5 to 0.5 / 0.0 / 0.1 %]
2113	Sub-scan Mag.	Sub Scan Magnification
2113 001	Sub-scan Mag.	Adjusts the sub scan magnification. [-0.5 to 0.5 / 0.0 / 0.1 %]
2201	DV Roller Bias DFU	Development roller bias adjustment
2201 001	DV Roller Bias	Adjusts the development bias for printing. [100 to 800 / 600 / 1 V]
2301	Transfer Current Adj.	Transfer roller Current Adjustment
2301 001	Transfer Current Adj.	Adjusts the correction current applied to the transfer roller. [-3 to +3 / 0 / 1 uA]
2902	Test Pattern	Printing Test Patterns

2902 003	Test Pattern		Prints the test patterns. Select the number of the test pattern that you want to print. When adjusting the printing registration, select no. 14 (Trimming Area Pattern) [0 to 30 / 0 / 1]	
	0	None	16	Hound's Tooth Check (Horizontal)
	1	Vertical Line (1 dot)	17	Band (Horizontal)
	2	Vertical Line (2 dot)	18	Band (Vertical)
	3	Horizontal Line (1 dot)	19	Checker Flag Pattern
	4	Horizontal Line (2 dot)	20	Density Pattern
	5	Grid Vertical Line	21	Full Dot Pattern
	6	Grid Horizontal Line	22	Full White Pattern
	7	Grid Pattern Small	23	Grayscale (Horizontal Margin)
	8	Grid Pattern Large	24	Grayscale White (Horizontal Margin)
	9	Argyle Pattern Small	25	Grayscale (Vertical Margin)
	10	Argyle Pattern Large	26	Grayscale White (Vertical Margin)
	11	Independent Pattern (1 dot)	27	Grayscale
	12	Independent Pattern (2 dot)	28	Grayscale White
	13	Independent Pattern (4 dot)	29	Grayscale (Cross Margin)
	14	Trimming Area	30	Grayscale White (Cross Margin)
15	Hound's Tooth Check (Vertical)			

SP3-xxx: Process

3926	Filming Prevent	Prevention of Filming
------	-----------------	-----------------------

3926 001	Filming Prevent	<p>[0 to 1 / 0 / 1]</p> <p>0: No 1: Yes</p> <p>If set to "Yes": This is done every 50 prints, for 0.2 s, to lubricate the cleaning blade. The charge roller voltage is cut, and toner is transferred to the cleaning blade. If the 50-print interval is reached during a job, printing stops and this process is done.</p> <p>Set this to yes to prevent the following:</p> <ul style="list-style-type: none"> • Grey banding parallel to the paper feed direction • Cleaning blade flipping due to friction between blade and drum <p>Noise due to friction between blade and drum</p>
----------	-----------------	---

SP5-xxx: Mode

5001	All Indicators On	
5001 001	All Indicators On	Turns on or off the all indicators on the operation panel.
5024	mm/inch Selection	
5024 001	0:mm 1:inch	<p>Measuring Unit Selection mm/inch</p> <p>Selects the unit of measurement.</p> <p>After selection, turn the main power switch off and on.</p> <p>0: mm(Europe/Asia) 1: inch(North America)</p>
5051	Refill Toner Disp	
5051 001	Refill Toner Disp	<p>Toner Refill Detect Display</p> <p>This SP switches on/off the message that prompts the operator when it is necessary to replenish toner in the machine.</p> <p>0: ON (Message displayed) 1: OFF (Message not displayed)</p>

5055	DisplayIPAddress	Display IP Address
5055 001	DisplayIPAddress	<p>Switches the banner display of the IP address off and on.</p> <p>[0 to 1 / 0 / 1]</p> <p>0: No</p> <p>1: Yes</p> <p>For example, if this SP is switched on, the IP address will be displayed below "Ready" while the printer is in standby mode:</p> <p>Ready 169.254.187.055</p>
5056	Coverage Counter	
5056 001	Coverage Counter	<p>Display or does not display the coverage counter on the LCD.</p> <p>[0 to 1 / 0 / 1]</p> <p>0: Not displayed</p> <p>1: Displayed</p>
5169	CE Login	Login as a CE
5169 001	CE Login	<p>If you will change the printer bit switches, you must 'log in' to service mode with this SP before you go into the printer SP mode.</p> <p>[0 to 1 / 0 / 1]</p> <p>0: Off. Printer bit switches cannot be adjusted.</p> <p>1: On. Printer bit switches can be adjusted.</p>
5195	Limitless SW	
5195 001	Limitless SW	[0 to 1 / 0 / 1]
5302	Set Time	Local time setting

5302 002	Time Difference	<p>Sets the time clock for the local time. This setting is done at the factory before delivery. The setting is GMT expressed in minutes.</p> <p>[-1440 to 1440 / -300 / 1 min. step]</p> <p>Japan: +540 (Tokyo) NA: -300 (NY) EU: +60 (Paris) CH: +480 (Peking) TW: +480 (Taipei) AS: +480 (Hong Kong) KO: +540 (Korea)</p>
----------	-----------------	--

5

RTB 7c (Ver 2.02)
 SP 5-305-101

5307	Summer Time	Summer time start/end Setting
	<p>Lets you set the machine to adjust its date and time automatically with the change to Daylight Savings time in the spring and back to normal time in the fall. This SP lets you set these items:</p> <ul style="list-style-type: none"> • Day and time to go forward automatically in April. • Day and time to go back automatically in October. • Set the length of time to go forward and back automatically. <p>The settings for 002 and 003 are done with 8-digit numbers:</p>	
	Digits	Meaning
	1st, 2nd	Month. 4: April, 10: October (for months 1 to 9, the first digit of 0 cannot be input, so the eight-digit setting for 002 or 003 becomes a seven-digit setting)
	3rd	Day of the week. 0: Sunday, 1: Monday
	4th	The number of the week for the day selected at the 3rd digit. If "0" is selected for "Sunday", for example, and the selected Sunday is the start of the 2nd week, then input a "2" for this digit.
	5th, 6th	The time when the change occurs (24-hour as hex code). Example: 00:00 (Midnight) = 00, 01:00 (1 a.m.) = 01, and so on.
	7th	The number of hours to change the time. 1 hour: 1
	8th	If the time change is not a whole number (1.5 hours for example), digit 8 should be 3 (30 minutes).
5307 001	ON/OFF	<p>Enables/disables the settings for 002 and 003.</p> <p>[0 or 1 / 1 (NA/EU), 0 (AA/CHN) / -]</p> <p>0: OFF</p> <p>1: ON</p>
5307 003	Start	The start of summer time.
5307 004	End	The end of summer time.

5401	Access Control	New user codes addition setting
	Determines whether the machine adds new user codes in the User Management Tool in Smart Net Monitor.	
5401 104	Authentication Time	Specifies the time for the authentication timeout. 0: 60 seconds 1 to 255: displayed time (seconds) [0 to 255 / 0 / 1 second]
5401 162	Extend Certification	Extends the certification of user. 0x00: No extension 0x01: Extension [0x00 to 0xFF / 0x00 / 1]
5401 200	SDK1 UniqueID	"SDK" is the "Software Development Kit". This data can be converted from SAS (VAS) when installed or uninstalled. (DFU)
5401 201	SDK1 Certification Method	
5401 210	SDK2 UniqueID	
5401 211	SDK2 Certification Method	
5401 220	SDK3 UniqueID	
5401 221	SDK3 Certification Method	
5401 230	SDK Certification	
5401 240	Detail Option	Enalbes or disables the log out confirmation option. <ul style="list-style-type: none"> Bit 0: Log out confirmation option 0: Enable 1: Disable Selects the automatic log out time. Bit 1 and 2: Automatic log out timer reduction 00: 60 seconds 01: 10 seconds 10: 20 seconds 11: 30 seconds
5404	User Code Clear	User Code Clearance

5404 001	User Code Clear	Clears the counts for the user codes assigned by the key operator to restrict the use of the machine. Press [OK] to clear.
----------	-----------------	--

5411	LDAP-Certification	Loading application certification setting
5411 004	Easy Certification	Determines whether easy LDAP certification is done. [0 to 1 / 1 / 1] 1: On 0: Off
5411 005	Password Null Not Permit	This SP is referenced only when SP5411-004 is set to "1" (On). [0 to 1 / 0 / 1] 0: Password NULL not permitted. 1: Password NULL permitted.
5411 006	Detail Option	-

5413	Lockout Setting	Local address book account lock
5413 001	Lockout On/Off	Turns on or off the account lock for the local address book account. [0 to 1 / 0 / 1] 0: OFF 1: ON
5413 002	Lockout Threshold	Sets a limit on the frequency of lockouts for account lockouts. [1 to 10 / 5 / 1]
5413 003	Cancellation On/Off	Determines whether the system waits the prescribed time for input of a correct user ID and password after an account lockout has occurred. [0 to 1 / 0 / 1] 0: Off (no wait time, lockout not cancelled) 1: On (system waits, cancels lockout if correct user ID and password are entered.

5413 004	Cancellation Time	Determines the length of time that the system waits for correct input of the user ID and password after a lockout has occurred. This setting is used only if SP5413-3 is set to "1" (on). [1 to 9999 / 60 / 1 min.]
----------	-------------------	---

5414	Access Mitigation	Consecutive access mitigation
5414 001	Mitigation On/Off	Permits or does not permit consecutive access to the machine with the same ID and password. [0 to 1 / 0 / 1] 0: Off (Permitted) 1: On (Not permitted)
5414 002	Mitigation Time	Sets the prohibiting time for consecutive access to the machine with the same ID and password. [0 to 60 / 15 / 1 min]

5415	Password Attack	Password attacking threshold setting
5415 001	Permission Number	Sets the threshold number of attempts to attack the system with random passwords to gain illegal access to the system. [0 to 100 / 30 / 1 times]
5415 002	Detect Time	Sets a detection time to count a password attack. [1 to 10 / 5 / 1 sec]

5416	Access Info	Access Information
5416 001	User Max Num	Sets the number of users for the access exclusion and password attack detection function. [50 to 200 / 200 / 1]
5416 002	Password Max Num	Sets the number of passwords for the access exclusion and password attack detection function. [50 to 200 / 200 / 1]

5416 003	Monitor interval	Sets the interval of watching out for user information and passwords. [1 to 10 / 3 / 1 second]
----------	------------------	--

5417	Access Attack	Access limitation setting
5417 001	Permission Num	Sets a limit on access attempts to prevent password cracking. [0 to 500 / 100 / 1]
5417 002	Attack Detect Time	Sets a detection time to count password cracking. [10 to 30 / 10 / 1 second]
5417 003	Cert Waite	Sets the wait time to slow down the speed of certification when an excessive number of access attempts have been detected. [0 to 9 / 3 / 1 second]
5417 004	Attack Max Num	Sets a limit on the number of requests received for certification in order to slow down the certification speed when an excessive number of access attempts have been detected. [50 to 200 / 200 / 1]

	User Auth	User Authentication
5420	These settings should be done with the System Administrator.  Note <ul style="list-style-type: none"> These functions are enabled only after the user access feature has been enabled. 	
5420 041	Printer	Determines whether certification is required before a user can use the printer application. [0 to 1 / 0 / 1] 0: ON 1: OFF

5420 051	SDK1	Determines whether certification is required before a user can use the SDK application. [0 or 1 / 0 / 1] 0: ON 1: OFF
5420 061	SDK2	
5420 071	SDK3	

5481	Auth. Error Code	Authentication failure code setting
	This SP code determines how the authentication failures are displayed.	
5481 001	System Log Disp	Determines whether an error code appears in the system log after a user authentication failure occurs. [0 to 1 / 0 / 1] 0: OFF 1: ON

5

5501	PM Alarm Interval	PM Alarm interval setting
5501 001	Printout	[0 to 9999 / 0 / 1] 0: Alarm off 1 to 9999: Alarm goes off when Value (1 to 9999) >= PM counter

5504	Jam Alarm	Jam level alarm setting
5504 001	Jam Alarm	Sets the alarm to sound for the specified jam level (document misfeeds are not included). [0 to 3 / 3 / 1] 0: Zero (Off) 1: Low (2.5K jams) 2: Medium (3K jams) 3: High (6K jams)

5505	Error Alarm DFU	Error Alarm level setting
5505 001	Error Alarm	Sets the error alarm level. [0 to 255 / 25 / 100 copies / 1 step]

5507	Supply Alarm	Paper supply control call setting
5507 001	Paper Size	Switches the control call on/off for the paper supply. DFU [0 to 1 / 0 / 1] 0: No alarm. 1: Sets the alarm to sound for the specified number transfer sheets for each paper size.
5507 004	MaintenanceKit	When switched on this function informs the @Remote supply center that the maintenance kit requires servicing. [0 to 1 / 1 / 1] 0: OFF 1: ON
5507 009	Cartridge	When switched on this function informs the @Remote supply center that the toner cartridge is almost empty (near-end). 0: OFF 1: ON
5507 080	Toner Call Timing	Selects the timing of the toner supply call for @Remote. 0: At Replacement 1: At near end
5507 128	Interval: Others	The "Paper Supply Call Level: nn" SPs specify the paper control call interval for the referenced paper sizes. DFU [00250 to 10000/1000/1]
5507 133	Interval: A4	
5507 134	Interval: A5	
5507 142	Interval: B5	
5507 164	Interval: LG	
5507 166	Interval: LT	
5507 172	Interval: HLT	

5515	SC/Alarm Setting	SC/Alarm call setting
	With @Remote in use, these SP codes can be set to issue an SC call when an SC error occurs. If this SP is switched off, the SC call is not issued when an SC error occurs.	
5515 001	SC Call	[0 or 1 / 1 / 1] 0: OFF 1: ON
5515 002	Service Parts Near End Call	[0 or 1 / 0 / 1] 0: OFF
5515 003	Service Parts End Call	1: ON
5515 004	User Call	[0 or 1 / 1 / 1]
5515 006	Communication Test Call	0: OFF
5515 007	Machine Information Notice	1: ON
5515 008	Alarm Notice	[0 or 1 / 0 / 1] 0: OFF 1: ON
5515 009	Non Genuine Toner	[0 or 1 / 1 / 1] 0: OFF 1: ON
5515 010	Supply Automatic Ordering Call	
5515 011	Supply Management Report Call	
5515 012	Jam/Door Open Call	
5733	MICR Setting	
5733 001	Model Switching	Switches the MICR model 0: RICOH Standard Model 1: Secure PCL MICR Model 2: IPDS MICR
5733 002	Print Availabili	Selects Not printing or printing with the MICR toner 0: Do not print 1: Print

5801	Memory Clear	Memory Clearance
	Resets NVRAM data to the default settings. Before executing any of these SP codes, print an SMC Report. Press [EXECUTE] to execute the memory clearance.	
5801 001	All Clear	Initializes items 2 to 15 below.
5801 002	Plotter Engine	Initializes all registration settings for the engine and process settings.
5801 003	SCS	Initializes default system settings, SCS (System Control Service) settings, operation display coordinates, and ROM update information.
5801 004	IMH Memory Clr	Initializes the image file system. (IMH: Image Memory Handler)
5801 005	MCS	Initializes the automatic delete time setting for stored documents. (MCS: Memory Control Service)
5801 008	Printer	Initializes the printer defaults, programs registered, the printer SP bit switches, and the printer CSS counter.
5801 010	GWWS/ NFA	Deletes the Netfile (NFA) management files and thumbnails, and initializes the Job login ID. Netfiles: Jobs to be printed from the document server using a PC and the DeskTopBinder software
5801 011	NCS	Initializes the system defaults and interface settings (IP addresses also), the SmartNetMonitor for Admin settings, Web Image Monitor settings, and the TELNET settings. (NCS: Network Control Service)
5801 014	Clear DCS Setting	Initializes the DCS (Delivery Control Service) settings.
5801 015	Clr UCS Setting	Initializes the UCS (User Information Control Service) settings.
5801 016	MIRS Setting	Initializes the MIRS (Machine Information Report Service) settings.

5801 017	CCS	Initializes the CCS (Certification and Charge-control Service) settings.
5801 018	SRM Memory Clr	Initializes information in non-volatile RAM.
5801 019	LCS	Initializes information in non-volatile RAM.
5801 021	ECS	Initializes the ECS settings.

5802	Free Run	Execution of a Free Run
5802 001	Free Run	<p>The machine performs a free run. [0 to 1 / 0 / 1] Press [#Enter] to start. Press [#Enter] to stop.</p> <p>Note</p> <ul style="list-style-type: none"> The machine will not stop immediately after the [#Enter] key is pressed.

5803	Input Check	
	Displays signals received from sensors and switches. SP Modes other than those listed in this table, are not used in the machine.	
	Operation Panel	Component Name
5803 001	Cover Open	Cover sensors [0x00 to 0x11 / 0x00 / 0x01]
5803 002	Main Motor: Lock	Main Motor lock [0x00 to 0x01 / 0x00 / 0x01]
5803 003	Polygon: Lock	Polygon Motor lock [0x00 to 0x01 / 0x00 / 0x01]
5803 005	Main FAN: Lock	Exhaust fan [0x00 to 0x01 / 0x00 / 0x01]
5803 006	PSU FAN: Lock	PSU fan [0x00 to 0x01 / 0x00 / 0x01]

5803 008	SCB: SET	SCB [0x00 to 0x01 / 0x00 / 0x01]
5803 009	Fusing Temp: Error	Fusing Temperature error, Overheat [0x00 to 0x01 / 0x00 / 0x01]
5803 010	Toner End Sensor	Toner end sensor [0x00 to 0x01 / 0x00 / 0x01]
5803 011	Paper Overflow SN	Paper Overflow sensor [0x00 to 0x01 / 0x00 / 0x01]
5803 012	Regist Sensor	Registration sensor [0x00 to 0x01 / 0x00 / 0x01]
5803 013	Paper Exit Ent SN	Paper Exit Entrance sensor [0x00 to 0x01 / 0x00 / 0x01]
5803 015	Duplex Relay SN	Duplex Relay sensor [0x00 to 0x01 / 0x00 / 0x01]
5803 016	Paper Ext Inv SN	Paper Exit Inverter sensor [0x00 to 0x01 / 0x00 / 0x01]
5803 017	Paper End Sensor	Paper end sensor, Standard Tray [0x00 to 0x01 / 0x00 / 0x01]
5803 018	Paper Height SN	Paper Height sensor, Standard Tray [0x000 to 0x111 / 0x000 / 0x001]
5803 019	Paper Size Sensor	Paper size switch, Standard tray [0x000 to 0x111 / 0x000 / 0x001]
5803 020	Bypass Paper End	Paper End, By-pass Tray [0x00 to 0x01 / 0x00 / 0x01]
5803 021	AIO FAN: Lock	AIO Fan lock [0x00 to 0x01 / 0x00 / 0x01]
5803 023	Trans Thermistor	Transfer Thermistor [-20 to 70 / 0 / 1 / deg]

5803 024	Fusing Thermistor	Fusing Thermistor [0 to 260 / 0 / 1 / deg]
5803 025	Fusing Unit Set	Fusing Unit set [0x0000 to 0xFFC0 / 0x0000 / 0x0001]
5803 026	HVPS: Transfer: IFB	HVPS unit Transfer current feedback [-10 to 48 / 0 / 1 / uA]
5803 027	HVPS: Charge: VFB	HVPS Charging Voltage feedback [-2500 to 0 / 0 / 1 / V]
5803 028	HVPS: Develop: VFB	HVPS Developing Voltage feedback [-1000 to 0 / 0 / 1 / V]
5803 029	Voltage Frequency	Power source Voltage Frequency [0 to 1 / 0 / 1]
5803 041	PFU1: Tray Set SN	Tray Set sensor, Standard tray [0 to 1 / 0 / 1]
5803 042	PFU1: Paper End SN	Paper End sensor, Standard tray [0 to 1 / 0 / 1]
5803 043	PFU1: T2 Trans SN	Transport sensor, Standard tray [0 to 1 / 0 / 1]
5803 044	PFU1: PaperSize SN	Paper Size switch, Standard Paper Tray [0 to 1 / 0 / 1]
5803 045	PFU1: T2 Rest SN	Paper Rest sensor, Standard tray [0 to 1 / 0 / 1]
5803 046	PFU2: Tray Set SN	Tray Set sensor, 1st Opt. Paper Tray [0 to 1 / 0 / 1]
5803 047	PFU2: Paper End SN	Paper End sensor, 1st Opt. Paper Tray [0 to 1 / 0 / 1]
5803 048	PFU2: T3 Trans SN	Transport sensor, 1st Opt. Paper Tray [0 to 1 / 0 / 1]

5803 049	PFU2: PaperSize SN	Paper Size switch, 1st Opt. Paper Tray [0 to 1 / 0 / 1]
5803 050	PFU2: T3 Rest SN	Paper Rest sensor, 1st Opt. Paper Tray [0 to 1 / 0 / 1]
5803 051	PFU3: Tray Set SN	Tray Set sensor, 2nd Opt. Paper Tray [0 to 1 / 0 / 1]
5803 052	PFU3: Paper End SN	Paper End sensor, 2nd Opt. Paper Tray [0 to 1 / 0 / 1]
5803 053	PFU3: T4 Trans SN	Transport sensor, 2nd Opt. Paper Tray [0 to 1 / 0 / 1]
5803 054	PFU3: PaperSize SN	Paper Size switch, 2nd Opt. Paper Tray [0 to 1 / 0 / 1]
5803 055	PFU3: T4 Rest SN	Paper Rest sensor, 2nd Opt. Paper Tray [0 to 1 / 0 / 1]
5803 056	PFU4: Tray Set SN	Tray Set sensor, 3rd Opt. Paper Tray [0 to 1 / 0 / 1]
5803 057	PFU4: Paper End SN	Paper End sensor, 3rd Opt. Paper Tray [0 to 1 / 0 / 1]
5803 058	PFU4: T5 Trans SN	Transport sensor, 3rd Opt. Paper Tray [0 to 1 / 0 / 1]
5803 059	PFU4: PaperSize SN	Paper Size switch, 3rd Opt. Paper Tray [0 to 1 / 0 / 1]
5803 060	PFU4: T5 Rest SN	Paper Rest sensor, 3rd Opt. Paper Tray [0 to 1 / 0 / 1]

5804	Output check	
	Turns on electrical components individually for test purposes. SP Modes other than those listed in this table, are not used in the machine.	
	Operation Panel	Component Name

5804 001	All OFF	All Off [0 to 1 / 0 / 1]
5804 002	Main Motor: H	Main Motor High speed [0 to 1 / 0 / 1]
5804 003	Main Motor: L	Main Motor Low speed [0 to 1 / 0 / 1]
5804 004	Duplex Motor: H	Duplex Motor High speed [0 to 1 / 0 / 1]
5804 005	Duplex Motor: L	Duplex Motor Low speed [0 to 1 / 0 / 1]
5804 006	Paper Ext Motor: H	Paper Exit Motor High speed [0 to 1 / 0 / 1]
5804 007	Paper Ext Motor: L	Paper Exit Motor Low speed [0 to 1 / 0 / 1]
5804 008	PaperExt MT:Rev:H	Paper Exit Motor Reverse High speed [0 to 1 / 0 / 1]
5804 009	PaperExt MT:Rev:L	Paper Exit Motor Reverse Low speed [0 to 1 / 0 / 1]
5804 010	Polygon Motor: H	Polygon Motor High speed [0 to 1 / 0 / 1]
5804 011	Polygon Motor: L	Polygon Motor Low speed [0 to 1 / 0 / 1]
5804 012	PSU FAN	PSU fan [0 to 1 / 0 / 1]
5804 013	Main FAN: H	Exhaust fan High speed [0 to 1 / 0 / 1]
5804 014	Relay CL	Relay Clutch [0 to 1 / 0 / 1]

5804 015	Paper Feed CL	Paper Feed Clutch [0 to 1 / 0 / 1]
5804 016	Bypass Feed CL	Bypass Feed Clutch [0 to 1 / 0 / 1]
5804 017	Regist CL	Registration Clutch [0 to 1 / 0 / 1]
5804 018	Duplex Junc SOL	Duplex Junction Solenoid [0 to 1 / 0 / 1]
5804 019	LD1	Force Test LD 1 [0 to 1 / 0 / 1]
5804 020	LD2	Force Test LD 2 [0 to 1 / 0 / 1]
5804 021	LD1 and LD2	Force Test LD 1 and LD 2 [0 to 1 / 0 / 1]
5804 022	Fusing Unit Fuse	Fusing Unit Fuse blow [0 to 1 / 0 / 1]
5804 024	HVPS: Charge	HVPS unit Charge [0 to 1 / 0 / 1]
5804 025	HVPS: Develop	HVPS unit Development [0 to 1 / 0 / 1]
5804 026	HVPS: Transfer+	HVPS unit Transfer Plus [0 to 1 / 0 / 1]
5804 027	HVPS: Transfer-	HVPS unit Transfer Minus [0 to 1 / 0 / 1]
5804 028	RFID: ON/OFF	RFID unit On and Off [0 to 1 / 0 / 1]
5804 029	RFID: Comm	RFID Communication [0 to 1 / 0 / 1]

5804 031	Main FAN: L	Exhaust fan Low speed [0 to 1 / 0 / 1]
5804 032	AIO FAN: H	AIO fan High speed [0 to 1 / 0 / 1]
5804 033	AIO FAN: L	AIO fan Low speed [0 to 1 / 0 / 1]
5804 034	Main Motor: Rev: H	Main Motor Reverse High speed [0 to 1 / 0 / 1]
5804 035	Main Motor: Rev: L	Main Motor Reverse Low speed [0 to 1 / 0 / 1]
5804 041	PFU : All OFF	Paper Tray All Off [0 to 1 / 0 / 1]
5804 042	PFU1: Motor: H	Paper Tray Motor-Standard Paper Tray High Speed [0 to 1 / 0 / 1]
5804 043	PFU1: Motor: L	Paper Tray Motor-Standard Paper Tray Low Speed [0 to 1 / 0 / 1]
5804 044	PFU1: PaperFeed CL	Paper Feed Clutch, Standard Paper Tray [0 to 1 / 0 / 1]
5804 045	PFU2: Motor: H	Paper Tray Motor-1st Opt. Paper Tray High Speed [0 to 1 / 0 / 1]
5804 046	PFU2: Motor: L	Paper Tray Motor-1st Opt. Paper Tray Low Speed [0 to 1 / 0 / 1]
5804 047	PFU2: PaperFeed CL	Paper Feed Clutch-1st Opt. Paper Tray [0 to 1 / 0 / 1]
5804 048	PFU3: Motor: H	Paper Tray Motor-2nd Opt. Paper Tray High Speed [0 to 1 / 0 / 1]
5804 049	PFU3: Motor: L	Paper Tray Motor-2nd Opt. Paper Tray Low Speed [0 to 1 / 0 / 1]

5804 050	PFU3: PaperFeed CL	Paper Feed Clutch-2nd Opt. Paper Tray [0 to 1 / 0 / 1]
5804 051	PFU4: Motor: H	Paper Tray Motor-3rd Opt. Paper Tray High Speed [0 to 1 / 0 / 1]
5804 052	PFU4: Motor: L	Paper Tray Motor-3rd Opt. Paper Tray Low Speed [0 to 1 / 0 / 1]
5804 053	PFU4: PaperFeed CL	Paper Feed Clutch-3rd Opt. Paper Tray [0 to 1 / 0 / 1]

5807		Destin./Model
5807 001	Destination Code	Sets the destination code. [1 to 7 / 2 / 1] 1: DOM (Japan) 2: NA (North America) 3: EU (Europe) 4: China 5: Asia 6: Taipei 7: Korea
5807 002	Type Code	Sets the machine type a / b. [0 to 1 / 1 / 1] 0: Type a 1: Type b
5807 003	Model Code	Sets the model (Basic) code. [0 to 2 / 0 / 1] 0: Basic model 1: 1 bin Model 2: Finisher Model

5810	Fusing SC Clear	Fusing SC error Clearance
-------------	-----------------	---------------------------

5810 001	Fusing SC Clear	Resets an SC code for a fusing unit error. After using this SP mode, turn the main switch off and on. [0 to 1 / 0 / 1]
----------	-----------------	--

5811	Machine Serial	
5811 002	Display	Displays a machine serial. [0 to 255 / 11 / 1]
5811 004	Set: BICU DFU	Used to input the machine serial number. This is normally done at the factory. [0 to 255 / 11 / 1]

5

5812	Service TEL	Support telephone number
	Use these SP modes to input service and support telephone numbers. Enter the number and press [OK]. Press the [Clear] key to delete the telephone number.	
5812 001	Telephone	Use this to input the telephone number of the CE printed on the SP print mode printout.
5812 002	Facsimile	Use this to input the fax number of the CE printed on the SP print mode printout.

5816	NRS Function	
5816 001	I/F Setting	Selects the remote service setting. [0 or 2 / 2 / 1] 0: OFF (Remote service off) 2: Network (@Remote remote service on)

5816 002	CE Call	<p>Performs the CE Call at the start or end of the service. [0 or 1 / 0 / 1 /step]</p> <p>0: Start of the service 1: End of the service</p> <p>Note</p> <ul style="list-style-type: none"> This SP is activated only when SP 5816-001 is set to "2".
5816 003	Function Flag	<p>Enables or disables the remote service function. [0 to 1 / 0 / 1]</p> <p>0: Disabled 1: Enabled</p>
5816 007	SSL Disable	<p>Uses or does not use the RCG certification by SSL when calling the RCG. [0 to 1 / 0 / 1]</p> <p>0: Uses the RCG certification 1: Does no use the RCG certification</p>
5816 008	RCG Connect T/O	<p>Specifies the connect timeout interval when calling the RCG. [1 to 90 / 30 / 1 second]</p>
5816 009	RCG Write Timeout	<p>Specifies the write timeout interval when calling the RCG. [0 to 100 / 60 / 1 second]</p>
5816 010	RCG Read Timeout	<p>Specifies the read timeout interval when calling the RCG. [0 to 100 / 60 / 1 second]</p>
5816 011	Port 80	<p>Enables/disables access via port 80 to the SOAP method. [0 or 1 / 0 / -]</p> <p>0: Disabled 1: Enabled</p>

5816 013	RFU Timing	<p>Selects the RFU (Remote Firmware Update) timing. [0 or 1 / 1 / -]</p> <p>0: RFU is executed whenever update request is received.</p> <p>1: RFU is executed only when the machine is in the sleep mode.</p>
5816 021	Function Flag	<p>This SP displays the embedded RCG installation end flag. [0 or 1 / 1 / -]</p> <p>0: Installation not completed</p> <p>1: Installation completed</p>
5816 022	Install Status	<p>This SP displays the external RCG installation status. [0 to 2 / 0 / -]</p> <p>0: External RCG not registered</p> <p>1: External RCG registered</p> <p>2: Device registered</p>
5816 023	Connect Mode (N/M)	<p>This SP displays and selects the embedded RCG connection method. [0 or 1 / 1 / -]</p> <p>0: Internet connection</p> <p>1: Dial-up connection</p>
5816 061	NotiTime ExpTime DFU	Proximity of the expiration of the certification.
5816 062	HTTP Proxy use	<p>This SP setting determines if the proxy server is used when the machine communicates with the service center. [0 or 1 / 0 / 1]</p> <p>0: HTTP Proxy not used</p> <p>1: HTTP Proxy used</p>

5816 063	HTTP Proxy Host	<p>This SP sets the address of the proxy server used for communication between embedded RCG-N and the gateway. Use this SP to set up or display the customer's proxy server address. The address is necessary to set up embedded RCG-N.</p> <p>Note</p> <ul style="list-style-type: none"> The address display is limited to 128 characters. Characters beyond the 128 character are ignored. This address is customer information and is not printed in the SMC report.
5816 064	HTTP Proxy Port	<p>This SP sets the port number of the proxy server used for communication between embedded RCG-N and the gateway. This setting is necessary to set up embedded RCG-N.</p> <p>Note</p> <ul style="list-style-type: none"> This port number is customer information and is not printed in the SMC report.
5816 065	HTTP Prox AutUsr	<p>This SP sets the HTTP proxy certification user name.</p> <p>Note</p> <ul style="list-style-type: none"> The length of the name is limited to 31 characters. Any character beyond the 31st character is ignored. This name is customer information and is not printed in the SMC report.
5816 066	HTTP Prox AutPass	<p>This SP sets the HTTP proxy certification password.</p> <p>Note</p> <ul style="list-style-type: none"> The length of the name is limited to 31 characters. Any character beyond the 31st character is ignored. This name is customer information and is not printed in the SMC report.

5816 067	Cer Updt Cond		Displays the status of the certification update.
	0	The certification used by embedded RCG is set correctly.	
	1	The certification request (setAuthKey) for update has been received from the GW URL and certification is presently being updated.	
	2	The certification update is completed and the GW URL is being notified of the successful update.	
	3	The certification update failed, and the GW URL is being notified of the failed update.	
	4	The period of the certification has expired and new request for an update is being sent to the GW URL.	
	11	A rescue update for certification has been issued and a rescue certification setting is in progress for the rescue GW connection.	
	12	The rescue certification setting is completed and the GW URL is being notified of the certification update request.	
	13	The notification of the request for certification update has completed successfully, and the system is waiting for the certification update request from the rescue GW URL.	
	14	The notification of the certification request has been received from the rescue GW controller, and the certification is being stored.	
	15	The certification has been stored, and the GW URL is being notified of the successful completion of this event.	
	16	The storing of the certification has failed, and the GW URL is being notified of the failure of this event.	
	17	The certification update request has been received from the GW URL, the GW URL was notified of the results of the update after it was completed, but an certification error has been received, and the rescue certification is being recorded.	
18	The rescue certification of No. 17 has been recorded, and the GW URL is being notified of the failure of the certification update.		

5816 068	Cer Abnml Cause		Displays a number code that describes the reason for the request for update of the certification.
	0	Normal. There is no request for certification update in progress.	
	1	Request for certification update in progress. The current certification has expired.	
	2	An SSL error notification has been issued. Issued after the certification has expired.	
	3	Notification of shift from a common authentication to an individual certification.	
	4	Notification of a common certification without ID2.	
	5	Notification that no certification was issued.	
	6	Notification that GW URL does not exist.	
5816 069	Cer Updt ReqID		The ID of the request for certification.
5816 083	Firm Updating		Displays the status of the firmware update.
5816 085	Firm UpUsr Conf		This SP setting determines if the operator can confirm the previous version of the firmware before the firmware update execution. If the option to confirm the previous version is selected, a notification is sent to the system manager and the firmware update is done with the firmware files from the URL.
5816 086	Firmware Size		Allows the service technician to confirm the size of the firmware data files during the firmware update execution.
5816 087	CERT: MacroVsn		Displays the macro version of the @Remote certification.
5816 088	CERT: PAC Vsn		Displays the PAC version of the @Remote certification.
5816 089	CERT: ID2 Code		Displays ID2 for the @Remote certification. Spaces are displayed as underscores (_). Asterisks (***) indicate that no @Remote certification exists.
5816 090	CERT: Subject		Displays the common name of the @Remote certification subject. CN = the following 17 bytes. Spaces are displayed as underscores (_). Asterisks (***) indicate that no DESS exists.

5816 091	CERT: SeriNum	Displays serial number for the @Remote certification. Asterisks (***) indicate that no DESS exists.
5816 092	CERT: Issuer	Displays the common name of the issuer of the @Remote certification. CN = the following 30 bytes. Asterisks (***) indicate that no DESS exists.
5816 093	CERT: St ExpTime	Displays the start time of the period for which the current @Remote certification is enabled.
5816 094	CERT: End ExpTime	Displays the end time of the period for which the current @Remote certification is enabled.
5816 200	Polling Man Exc	Executes manual polling. Cumin periodically polls the @Remote Gateway by HTTPS. This is called "center polling". Use this SP at any time to poll the @Remote supply center.
5816 201	Instl: Condition	Displays a number that indicates the status of the @Remote service device. 0: Neither the registered device by the embedded RCG nor embedded RCG device is set. 1: The embedded RCG device is being set. Only Box registration is completed. In this status the external RCG unit cannot answer a polling request. 2: The embedded RCG device is set. In this status the external RCG unit cannot answer a polling request. 3: The registered device by the embedded RCG is being set. In this status the embedded RCG device cannot be set. 4: The registered module by the embedded RCG has not started.
5816 202	Instl: ID #	Allows entry of the number of the request needed for the embedded RCG device.
5816 203	Instl: Reference	Executes the inquiry request to the @Remote GateWay URL.

5816 204	Instl: Ref Rslt	<p>Displays a number that indicates the result of the inquiry executed with SP5816 203.</p> <p>0: Succeeded</p> <p>1: Inquiry number error</p> <p>2: Registration in progress</p> <p>3: Proxy error (proxy enabled)</p> <p>4: Proxy error (proxy disabled)</p> <p>5: Proxy error (Illegal user name or password)</p> <p>6: Communication error</p> <p>7: Certification update error</p> <p>8: Other error</p> <p>9: Inquiry executing</p>	
5816 205	Instl: Ref Section	<p>Displays the result of the notification sent to the device from the GW URL in answer to the inquiry request. Displayed only when the result is registered at the GW URL.</p>	
5816 206	Instl: Rgsltln	<p>Executes Embedded RCG Registration.</p>	
5816 207	Instl: Rgsltln Rst	<p>Displays a number that indicates the registration result.</p> <p>0: Succeeded</p> <p>2: Registration in progress</p> <p>3: Proxy error (proxy enabled)</p> <p>4: Proxy error (proxy disabled)</p> <p>5: Proxy error (Illegal user name or password)</p> <p>6: Communication error</p> <p>7: Certification update error</p> <p>8: Other error</p> <p>9: Registration executing</p>	
5816 208	Instl: ErrorCode	<p>Displays a number that describes the error code that was issued when either SP5816-204 or SP5816-207 was executed.</p>	
	Cause	Code	Meaning

	Illegal Modem Parameter	-11001	Chat parameter error
		-11002	Chat execution error
		-11003	Unexpected error
	Operation Error, Incorrect Setting	-12002	Inquiry, registration attempted without acquiring device status.
		-12003	Attempted registration without execution of an inquiry and no previous registration.
		-12004	Attempted setting with illegal entries for certification and ID2.
5	Confirmation error, Incorrect certification	-12005	@Remote communication is prohibited. The device has an Embedded RC gate-related problem.
		-12006	A confirmation request was made after the confirmation had been already completed.
		-12007	The request number used at registration was different from the one used at confirmation.
		-12008	Update certification failed because mainframe was in use.

	Error Caused by Response from GW URL	-2385	Attempted dial up overseas without the correct international prefix for the telephone number.
		-2387	Not supported at the Service Center
		-2389	Database out of service
		-2390	Program out of service
		-2391	Two registrations for same device
		-2392	Parameter error
		-2393	External RCG not managed
		-2394	Device not managed
		-2395	Box ID for External RCG is illegal
		-2396	Device ID for External RCG is illegal
		-2397	Incorrect ID2 format
		-2398	Incorrect request number format
5816 209	Instl Clear	Releases the machine from its embedded RCG setup.	
5816 250	Print Com Log	Prints the communication log.	

5821	NRS Address		
5821 002	RCG IP Address	Sets the IP address of the RCG (Remote Communication Gate) destination for call processing at the remote service center. [00000000h to FFFFFFFFh / 00000000h / -]	

5824	NVRAM Upload		
5824 001	NVRAM Upload	Uploads the UP and SP mode data (except for counters and the serial number) from NVRAM on the control board to a flash memory card. While using this SP mode, always keep the front cover open. This prevents a software module accessing the NVRAM during the upload.	

5825	NVRAM Download	
5825 001	NVRAM Download	Downloads the content of a flash memory card to the NVRAM on the control board.
5828	Network Setting	
	This machine supports both Internet Protocols IPv4 and IPv6. IPv6 is the next generation protocol designed by the IETF to replace IPV4. IPv6 adds many improvements such as routing and network auto-configuration.	
5828 050	1284 Compatiblrit	Enables and disables bi-directional communication on the parallel connection between the machine and a computer. [0 to 1 / 1 / -] 0:Off 1: On
5828 052	ECP(Centro)	Disables and enables the ECP feature (1284 Mode) for data transfer. [0 to 1 / 1 / -] 0: Disabled 1: Enabled
5828 065	Job Spooling	Switches job spooling on and off. [0 to 1 / 1 / -] 0: No spooling 1: Spooling enabled
5828 066	Job Spooling Clear	This SP determines whether the job interrupted at power off is resumed at the next power on. This SP operates only when SP5828 065 is set to 1. [0 to 1 / 1 / -] 1: OFF (Resumes printing spooled jog.) 0: ON (Clears spooled job.)

5828 069	JobSpooling(Protocl)	<p>This SP determines whether job spooling is enabled or disabled for each protocol. This is an 8-bit setting.</p> <p>Bit 0: LPR</p> <p>Bit 1: FTP (Not Used)</p> <p>Bit 2: IPP</p> <p>Bit 3: SMB</p> <p>Bit 4: BMLinks (Japan Only)</p> <p>Bit 5: DIPRINT</p> <p>Bit 6: Reserved (Not Used)</p> <p>Bit 7: Reserved (Not Used)</p> <p>Default: 01111111b (7f H)</p>
5828 090	TELNET(0:OFF 1:0...	<p>Disables or enables Telnet operation. If this SP is disabled, the Telnet port is closed.</p> <p>[0 to 1 / 1 / -]</p> <p>0: OFF</p> <p>1: ON</p>
5828 091	Web(0:OFF 1:ON)	<p>Disables or enables the Web operation.</p> <p>[0to1 / 1 / -]</p> <p>0: OFF</p> <p>1: ON</p>
5828 145	Active IPv6 Link Local	<p>This is the IPv6 local address referenced on the Ethernet or wireless LAN (802.11) in the format:</p> <p>"Link-Local address" + "Prefix Length"</p> <p>The IPv6 address consists of a total 128 bits configured in 8 blocks of 16 bits each. These notations can be abbreviated. See "Note: IPV6 Addresses " below this table.</p>
5828 147	Active IPv6 Stat 1	<p>These SPs are the IPv6 stateless addresses (1 to 5) referenced on the Ethernet or wireless LAN (802.11) in the format:</p> <p>"Stateless Address" + "Prefix Length"</p> <p>The IPv6 address consists of a total 128 bits configured in 8 blocks of 16 bits each.</p>
5828 149	Active IPv6 Stat 2	
5828 151	Active IPv6 Stat 3	
5828 153	Active IPv6 Stat 4	
5828 155	Active IPv6 Stat 5	

5828 156	IPv6 Manual Address	<p>This SP is the IPv6 manually set address referenced on the Ethernet or wireless LAN (802.11) in the format: "Manual Set Address" + "Prefix Length"</p> <p>The IPv6 address consists of a total 128 bits configured in 8 blocks of 16 bits each. These notations can be abbreviated. See "Note: IPV6 Addresses" below this table.</p>
5828 158	IPv6 Gateway Address	<p>This SP is the IPv6 gateway address referenced on the Ethernet or wireless LAN (802.11). The IPv6 address consists of a total 128 bits configured in 8 blocks of 16 bits each. These notations can be abbreviated. See "Note: IPV6 Addresses" below this table.</p>
5828 161	IPv6 Stateless Auto	<p>Enables or disables the IPv6 Stateless Auto setting on the Ethernet or wireless LAN (802.11).</p> <p>[0 to 1 / 1 / -]</p> <p>0: Off</p> <p>1: On</p>

↓ Note

- **IPV6 Addresses**
- Ethernet and the Wireless LAN (802.11) reference the IPV6 "Link-Local address + Prefix Length". The IPV6 address consists of 128 bits divided into 8 blocks of 16 bits:
 - aaaa:bbbb:cccc:dddd:eeee:ffff:gggg:hhhh:
 - The prefix length is inserted at the 17th byte (Prefix Range: 0x0to0x80). The initial setting is 0x40(64).
 - For example, the data:
 - 2001123456789012abcdef012345678940h
 - is expressed:
 - 2001:1234:5678:9012:abcd:ef01:2345:6789: prefixlen 64
 - However, the actual IPV6 address display is abbreviated according to the following rules.
 - **Rules for Abbreviating IPV6 Addresses**
 1. The IPV6 address is expressed in hexadecimal delimited by colons (:) with the following characters:
 - 0123456789abcdefABCDEF
 2. A colon is inserted as a delimiter every 4th hexadecimal character.

fe80:0000:0000:0000:0207:40ff:0000:340e

3. The notations can be abbreviated by eliminating zeros where the MSB and digits following the MSB are zero. The example in "2" above, then, becomes:

fe80:0:0:0207:40ff:0:340e

4. Sections where only zeros exist can be abbreviated with double colons (::). This abbreviation can be done also where succeeding sections contain only zeros (but this can be done only at one point in the address). The example in "2" and "3" above then becomes: fe80::207:40ff:0:340e (only the first null sets zero digits are abbreviated as "::")

-or-

- fe80:0:0:0:207:40ff::340e (only the last null set before "340e" is abbreviated as "::")

5828 236	Web Item visible	Displays or does not display the Web system items. [0x0000 to 0xFFFF / 0xFFFF / -] 0: Not displayed 1: Displayed bit0: Net RICOH bit1: Consumable Supplier bit2-15: Reserved (all)
5828 237	Web shop Link	Displays or does not display the link to Net RICOH on the top page and link page of the web system. [0 to 1 / 1 / 1] 0: Not display 1: Display
5828 238	Web supplies Link	Displays or does not display the link to Consumable Supplier on the top page and link page of the web system. [0 to 1 / 1 / 1] 0: Not display 1:Display
5828 239	Web Link1 Name	This SP confirms or changes the URL1 name on the link page of the web system. The maximum characters for the URL name are 31 characters.
5828 240	Web Link1 URL	This SP confirms or changes the link to URL1 on the link page of the web system. The maximum characters for the URL are 127 characters.

5828 241	Web Link1 visible	Displays or does not display the link to URL1 on the top page of the web system. [0 to 1 / 1 / 1] 0: Not display 1: Display
5828 242	Web Link2 Name	Same as "-239" (URL2)
5828 243	Web Link2 URL	Same as "-240"
5828 244	Web Link2 visible	Same as "-241"

5832	HDD	
5832 001	Formatting (ALL)	Initializes the hard disk. Use this only if there is a hard disk error.

5837	Program checksum	
5837 001	Program checksum	Displays the checksum for the engine firmware.

5840	IEEE 802.11	
5840 006	Channel max	Sets the maximum range of the bandwidth for the wireless LAN. This bandwidth setting varies for different countries. [1 to 14 / 11 (NA), 13 (EU), 14 (JPN) / 1] JPN: 1 to 14 NA: 1 to 11 EU: 1 to 13
5840 007	Channel MIN	Sets the minimum range of the bandwidth for operation of the wireless LAN. This bandwidth setting varies for different countries. [1 to 14 / 1 / 1] JPN: 1 to 14 NA: 1 to 11 EU: 1 to 13

5840 008	Transmission Speed	<p>[0x00 to 0xFF / 0xFF to Auto / -]</p> <p>0x11 - 55M Fix 0x10 - 48M Fix 0x0F - 36M Fix 0x0E - 18M Fix 0x0D - 12M Fix 0x0B - 9M Fix 0x0A - 6M Fix 0x07 - 11M Fix 0x05 - 5.5M Fix 0x08 - 1M Fix 0x13 - 0xFE (reserved) 0x12 - 72M (reserved) 0x09 - 22M (reserved)</p>
5840 011	WEP Key Select	<p>Selects the WEP key. Bit 1 and 0</p> <p>00: Key1 01: Key2 (Reserved) 10: Key3 (Reserved) 11: Key4 (Reserved)</p> <p>This SP is displayed only when the IEEE802.11 card is installed.</p>
5840 042	Fragment Thresh	<p>Adjusts the fragment threshold for the IEEE802.11 card.</p> <p>[256 to 2346 / 2346 / 1]</p> <p>This SP is displayed only when the IEEE802.11 card is installed.</p>

5840 043	11g CTS to Self	<p>Determines whether the CTS self function is turned on or off.</p> <p>[0 to 1 / 1 / 1]</p> <p>0: Off</p> <p>1: On</p> <p>This SP is displayed only when the IEEE802.11 card is installed.</p>
5840 044	11g Slot Time	<p>Selects the slot time for IEEE802.11.</p> <p>[0 to 1 / 0 / 1]</p> <p>0: 20 μ seconds</p> <p>1: 9 μ seconds</p> <p>This SP is displayed only when the IEEE802.11 card is installed.</p>
5840 045	WPA Debug Lvl	<p>Selects the debug level for WPA authentication application.</p> <p>[1 to 3 / 3 / 1]</p> <p>1: Info</p> <p>2: warning</p> <p>3: error</p> <p>This SP is displayed only when the IEEE802.11 card is installed.</p>

5842	GWWS Analysis (DFU)	
	This is a debugging tool. It sets the debugging output mode of each Net File process. Bit SW 0011 1111	
	Bit	Groups
	0	System & other groups (LSB)
	1	Capture related
	2	Certification related
	3	Address book related
	4	Machine management related
	5	Output related (printing, delivery)
6	Repository related	
5842 001	Setting 1	Default: 00000000 – do not change Netfiles: Jobs to be printed from the document server using a PC and the DeskTopBinder software
5842 002	Setting 2	Adjusts the debug program mode setting. Bit7: 5682 mmseg-log setting 0: Date/Hour/Minute/Second 1: Minute/Second/Msec. 0 to 6: Not used

5844	USB	
5844 001	Transfer Rate	Sets the speed for USB data transmission. [0x01 to 0x04 / 0x04 / -] 0x01: Full Speed 0x04: Auto Change
5844 002	Vendor ID	DFU
5844 003	Product ID	DFU
5844 004	Device Release Number	DFU

5844 005	Fixed USB Port	Fixes a PnP name of USB [0 to 2 / 0 / 1] 0:OFF 1:Level1 2:Level2
5844 006	PnP Model Name	Sets the PnP name when Sp5844-005 is set to On (1 or 2).
5844 007	PnP Serial Number	Sets the USB serial number when SP5844-005 is set to On (1 or 2). Default: a number generated from model name
5844 100	Notify Unsupport	Enable/disables the unsupported device notification [0 to 1 / 1 / 1] 1: enable 2: disable

5845	Delivery Srv	
	Provides items for delivery server settings.	
5845 003	Retry Interval	Determines the time interval between retries before the machine returns to standby after an error occurs during an image transfer with the delivery scanner or SMTP server. [60 to 900 / 300 / 1 second]
5845 004	No. of Retries	Determines the number of retries before the machine returns to standby after an error occurs during an image transfer with the delivery or SMTP server. [0 to 99 / 3 / 1]
5845 022	InstantTrans Off	Enables or disables the prevention function for the continuous data sending error. [0 to 1 / 1 / -] 0: Disable 1: Enable

5846	UCS Setting	
-------------	-------------	--

5846 010	LDAP Search TOut	<p>Sets the length of the time-out for the search of the LDAP server.</p> <p>[1 to 255 / 60 / 1]</p>
5846 041	AddrB Acl Info	<p>This SP must be executed immediately after installation of an HDD unit in a basic machine that previously had no HDD. The first time the machine is powered on with the new HDD installed, the system automatically takes the address book from the NVRAM and writes it onto the new HDD. However, the new address book on the HDD can be accessed only by the system administrator at this stage. Executing this SP by the service technician immediately after power on grants full address book access to all users.</p> <p>Procedure</p> <ol style="list-style-type: none"> 1. Turn the machine off. 2. Install the new HDD. 3. Turn the machine on. 4. The address book and its initial data are created on the HDD automatically. However, at this point the address book can be accessed by only the system administrator or key operator. 5. Enter the SP mode and do SP5846 041. After this SP executes successfully, any user can access the address book.
5846 043	AddrB Media	<p>Displays the slot number where an address book data is in.</p> <p>[0 to 30 / - / 1]</p> <p>0: Unconfirmed</p> <p>1: SD Slot 1</p> <p>2: SD Slot 2</p> <p>4: USB Flash ROM</p> <p>20: HDD</p> <p>30: Nothing</p>
5846 047	Ini Local AddrB	<p>Clears all of the address information from the local address book of a machine managed with UCS.</p>

5846 049	Ini LDAP AddrB	Press [EXECUTE] to delete all items (this does not include user codes) in the LDAP address book that is controlled by UCS.
5846 050	Ini All AddrB	Clears everything (including users codes) in the directory information managed by UCS. However, the accounts and passwords of the system administrators are not deleted.
5846 051	Bkup All AddrB	Copies all directory information to the SD card. Do this SP before replacing the controller board or HDD. The operation may not succeed if the controller board or HDD is damaged.
5846 052	Restr All AddrB	Copies back all directory information from the SD card to the flash ROM or HDD. Upload the address book from the old flash ROM or HDD with SP5846-51 before removing it. Do SP5846-52 after installing the new HDD.
5846 053	Clear Backup Info	Deletes the address book uploaded from the SD card in the slot 2. Deletes only the files uploaded for that machine. This feature does not work if the card is write-protected. Note: After you do this SP, go out of the SP mode, turn the power off. Do not remove the SD card until the Power LED stops flashing.

5846 060	Search option	This SP uses bit switches to set up the fuzzy search options for the UCS local address book.	
		Bit	Meaning
		0	Checks both upper/lower case characters
		1	Japan Only
		2	
		3	
		4	--- Not Used ---
		5	--- Not Used ---
		6	--- Not Used ---
7	--- Not Used ---		
5846 062	Compl Opt 1	<p>Use this SP to set the conditions for password entry to access the local address book. Specifically, this SP limits the password entry to upper case and sets the length of the password.</p> <p>[0 to 32 / 0 / 1]</p> <p>Note</p> <ul style="list-style-type: none"> This SP does not normally require adjustment. This SP is enabled only after the system administrator has set up a group password policy to control access to the address book. 	
5846 063	Compl Opt 2	<p>Use this SP to set the conditions for password entry to access the local address book. Specifically, this SP limits the password entry to lower case and defines the length of the password.</p> <p>[0 to 32 / 0 / 1 step]</p> <p>Note</p> <ul style="list-style-type: none"> This SP does not normally require adjustment. This SP is enabled only after the system administrator has set up a group password policy to control access to the address book. 	

5

5846 064	Compl Opt 3	<p>Use this SP to set the conditions for password entry to access the local address book. Specifically, this SP limits the password entry to numbers and defines the length of the password.</p> <p>[0 to 32 / 0 / 1 step]</p> <p>Note</p> <ul style="list-style-type: none"> This SP does not normally require adjustment. This SP is enabled only after the system administrator has set up a group password policy to control access to the address book.
5846 065	Compl Opt 4	<p>Use this SP to set the conditions for password entry to access the local address book. Specifically, this SP limits the password entry to symbols and defines the length of the password.</p> <p>[0 to 32 / 0 / 1 step]</p> <p>Note</p> <ul style="list-style-type: none"> This SP does not normally require adjustment. This SP is enabled only after the system administrator has set up a group password policy to control access to the address book.
5846 094	Encryption Stat	<p>Shows the status of the encryption function of the address book on the LDAP server.</p> <p>[0 to 255 / - / 1] No default</p>

5848	Web Service	
5848 004	ac:UD	Switches access control on and off.
5848 009	ac:Job Ctrl	
5848 011	ac:Dev Mng	0000: OFF
5848 022	ac:Uadmin	0001: ON

5848 210	LogType:Job1 DFU	<p>Note</p> <ul style="list-style-type: none"> These SP codes are for display only; they cannot be changed.
5848 211	LogType:Job2 DFU	
5848 212	LogType:Access DFU	
5848 213	PrimarySrv DFU	
5848 214	Secondary Srv DFU	
5848 215	StartTime DFU	
5848 216	IntervalTime DFU	
5848 217	Timing DFU	<p>Note</p> <ul style="list-style-type: none"> These SP codes are for display only; they cannot be changed. <p>[0 to 2 / 0 / 1]</p> <p>0: Transmission off</p> <p>1: Transmission 1 by 1</p> <p>2: Periodic transmission</p>

5849	Installation Date	
	Displays or prints the installation date of the machine.	
5849 001	Display	Displays the installation date of the machine.
5849 002	Print	<p>Determines whether the installation date is printed on the printout for the total counter.</p> <p>[0 to 1 / 1 / -]</p> <p>0: OFF (No Print)</p> <p>1: ON (Print)</p>
5849 003	Total Counter	Displays the total counter of the machine installation's day.

5851 *1	Bluetooth (The Printer model has no Bluetooth options)	
	<p>Sets the Bluetooth security mode.</p> <p>0: Public</p> <p>1: Private</p>	

5856	Remote ROM Update	
5856 002	Local Port	<p>When set to "enable" allows reception of firmware data via the local port (IEEE 1284) during a remote ROM update.</p> <p>0: Disallow</p> <p>1: Allow</p> <p>This setting is reset to "disable" after the machine is cycled off and on.</p>

5857	Debug Log Save	
5857 001	ON/OFF	<p>Switches on the debug log feature. The debug log cannot be captured until this feature is switched on.</p> <p>[0 to 1 / 0 / 1]</p> <p>0: OFF</p> <p>1: ON</p>
5857 002	Target 2:HDD 3:SD	<p>Selects the destination where the debugging information generated by the event selected by SP5858 will be stored if an error is generated</p> <p>[2 to 3 / 2 / 1]</p> <p>2: HDD</p> <p>3: SD Card</p>
5857 005	Save to HDD	Specifies the decimal key number of the log to be written to the hard disk.
5857 006	Save to SD Card	Specifies the decimal key number of the log to be written to the SD Card.
5857 009	HDD to SD Latest	<p>Takes the most recent 4 MB of the log written to the hard disk and copies them to the SD Card.</p> <p>A unique file name is generated to avoid overwriting existing file names on the SD Card. Up to 4MB can be copied to an SD Card. 4 MB segments can be copied one by one to each SD Card.</p>

5857 010	HDD to SD Any	<p>Takes the log of the specified key from the log on the hard disk and copies it to the SD Card.</p> <p>A unique file name is generated to avoid overwriting existing file names on the SD Card. Up to 4 MB can be copied to an SD Card. 4 MB segments can be copied one by one to each SD Card. This SP does not execute if there is no log on the HDD with no key specified.</p>
5857 011	Erase HDD Debug	Erases all debug logs on the HDD
5857 012	Erase SD Debug	<p>Erases all debug logs on the SD Card. If the card contains only debugging files generated by an event specified by SP5858, the files are erased when SP5857 010 or 011 is executed.</p> <p>To enable this SP, the machine must be cycled off and on.</p>
5857 013	Dsply-SD Space	Displays the amount of space available on the SD card.
5857 014	SD to SD Latest	Copies the last 4MB of the log (written directly to the card from shared memory) onto an SD card.
5857 015	SD to SD Any	This SP copies the log on an SD card (the file that contains the information written directly from shared memory) to a log specified by key number.
5857 016	Make HDD Debug	This SP creates a 32 MB file to store a log on the HDD.
5857 017	Make SD Debug	This SP creates a 4 MB file to store a log on an SD card.

5858	Debug Log Save: SC	
	<p>These SPs select the content of the debugging information to be saved to the destination selected by SP5857-002.</p> <p>SP5858-003 stores one SC specified by number.</p>	
5858 001	Engine SC	Stores SC codes generated by printer engine errors. (0: OFF 1: ON)
5858 002	Controller SC	Stores SC codes generated by GW controller errors. (0: OFF 1: ON)

5858 003	Any SC	[0 to 65535 / 0 / 1]
5858 004	Jam	Stores jam errors. (0: OFF 1: ON)

5859	Debug Log SaveKey	
5859 001	Key 1	<p>These SPs allow you to set up to 10 keys for log files for functions that use common memory on the controller board.</p> <p>[0 to 9999999 / 0 / 1]</p>
5859 002	Key 2	
5859 003	Key 3	
5859 004	Key 4	
5859 005	Key 5	
5859 006	Key 6	
5859 007	Key 7	
5859 008	Key 8	
5859 009	Key 9	
5859 010	Key 10	

5860	SMTP/POP3/IMAP4	
5860 002	SMTP Srvr Port No	Input the SMTP server port number.
5860 003	SMTP Authentication	SMTP authentication enable/disable [0 to 1 / 0 / 1] 0: Disable 1: Enable
5860 006	SMTP Auth. Encryp	Encryption mode for SMTP authentication enable/disable (Only valid if SP5-860-003 is set to "enable") [0 to 2 / 0 / 1] 0: Automatic 1: No encryption 2: Encrypt

5860 007	POP before SMTP	<p>Enable/disable POP before SMTP. If the SMTP server does not have authentication, you can enable POP before SMTP, then POP authentication is available (SP 5860 013)</p> <p>[0 to 1 / 0 / 1]</p> <p>0: Disable</p> <p>1: Enable</p>
5860 008	POPtoSMTP Waiting	<p>When using POP before SMTP, this SP mode determines the maximum wait time between POP authentication and connection with SMTP. Communication stops if this time is exceeded.</p> <p>[0 to 10000 / 300 / -]</p>
5860 009	Mail Receive Protocol	<p>Selects the protocol for the mail reception.</p> <p>[1 to 3 / 1 / 1]</p> <p>1: POP3</p> <p>2: IMAP4</p> <p>3: SMTP</p>
5860 013	POP3/IMAP4 Auth.	<p>If POP before SMTP is enabled, then you can use this SP to enable or disable encryption mode for POP authentication</p> <p>[0 to 2 / 0 / 1]</p> <p>0: Auto</p> <p>1: Off</p> <p>2: On</p>
5860 014	POP3 Srvr Port No	Input the POP server port number.
5860 015	IMAP4 Srvr Port...	<p>Input the IMAP4 server port number.</p> <p>[1 to 65535 / 143 / 1]</p>
5860 016	SMTP Rx Port No	<p>Input the SMTP port for the mail reception.</p> <p>[1 to 65535 / 25 / 1]</p>
5860 017	Mail Rx Interval	Specifies the interval for the mail reception.

5860 019	Mail Keep Setting	<p>Selects the mail saving setting.</p> <p>[0 to 2 / 0 / 1]</p> <p>0: Not saved in the mail server</p> <p>1: All saved in the mail server</p> <p>2: Only error mails saved in the mail server</p>
5860 020	ParMail RecTOut	<p>Sets the amount of time to wait before saving a mail that breaks up during reception. The received mail is discarded if the remaining portion of the mail is not received during this prescribed time.</p> <p>[1 to 168 / 72 / 1 hour]</p>
5860 021	MDN ResRFC2298	<p>Determines whether RFC2298 compliance is switched on for MDN reply mail.</p> <p>[0 to 1 / 1 / 1]</p> <p>0: No</p> <p>1: Yes</p>
5860 022	SMTPAut FieldRep	<p>If SMTP authentication is enabled, this SP mode determines which name is included in the e-mail header.</p> <p>[0 or 1 / 0 / -]</p> <p>0: Normal sender name</p> <p>1: User name used by the authentication feature</p>
5860 025	SMTPAut DirectSet DFU	<p>Select the authentication method for SMTP.</p> <p>Bit 0: LOGIN</p> <p>Bit 1: PLAIN</p> <p>Bit 2: CRAM_MD5</p> <p>Bit 3: DIGEST_MD5</p> <p>Bit 4 to Bit 7: Not Used</p> <p>Default: 00000000b</p> <p>Note</p> <ul style="list-style-type: none"> This SP is activated only when SMTP authentication is enabled by UP mode.

5860 026	S/MIME Header	<p>Selects the MIME header type of an E-mail sent by S/MIME.</p> <p>[0 to 2 / 0 / 1]</p> <p>0: Microsoft Outlook Express standard</p> <p>1: Internet Draft standard</p> <p>2: RFC standard</p>
----------	---------------	---

5866	E-Mail Report	
5866 001	Report Validity	<p>Enables or disables the E-mail alert function.</p> <p>[0 or 1 / 0 / -]</p> <p>0: Enabled</p> <p>1: Disabled</p>
5866 005	Add Date Field	<p>Adds or does not add the date field to the header of the alert mail.</p> <p>[0 or 1 / 0 / -]</p> <p>0: Not added</p> <p>1: Added</p>

5869	RAM Disk Setting	
5869 001	Mail Function	<p>This SP enables and disables email sending and receiving. This setting determines the size of the RAM disk (MB) that the machine uses to manage email sending and receiving.</p> <p>[0 to 1 / 0 / 1]</p> <p>0: Use. Allocates 46 MB for sending and 8 MB for receiving.</p> <p>1: Do not use</p>

5870	Common KeyInfo Writing	
	Writes to flash ROM the common proof for validating the device for @Remote specifications.	
	<p>Note</p> <ul style="list-style-type: none"> • These SP settings are required to connect @Remote or must also be set after the board is replaced. • Even if @Remote is not connected, these settings are used for Web validation, so at least SP5-870-003 must be enabled. 	
5870 001	Writing	Writes the authentication data (used for NRS) in the memory.
5870 003	Initialize	Initializes the authentication data in the memory.

5873	SDCardAppliMove	
	Allows you to move applications from one SD card another. For more, please refer to the "SD Card Application Move" section.	
5873 001	MoveExec	Executes the move from one SD card to another.
5873 002	UndoExec	This is an undo function. It cancels the previous execution.

5878	Option Setup	
5878 001	DataOverwriteSec.	Press [EXECUTE] to initialize the Data Overwrite Security option for the printer. For more, see "DataOverwriteSecurity Unit" in the chapter "Installation".
5878 002	HDD Encryption	Press [EXECUTE] to initialize the HDD Encryption option for the printer. For more, see "HDD Encryption" in the chapter "Installation".

5887	SD GetCounter	
5887 001	SD GetCounter	This SP outputs a text file (.txt) that lists the counts for the application SD card inserted into the SD service slot. Before executing this SP, you must first create a folder entitled "SD_COUNTER" in the root directory of the SD card.

5888	Person. InfoProt.	
5888 001	Person. InfoProt.	<p>Selects the protection level for logs.</p> <p>[0 to 1 / 0 / 1]</p> <p>0: No authentication, No protection for logs</p> <p>1: No authentication, Protected logs (only an administrator can see the logs)</p>

5893	SDK Apli Cnt Name	
	Displays the counter name of each SDK application.	
5893 001	SDK-1	
5893 002	SDK-2	
5893 003	SDK-3	
5893 004	SDK-4	
5893 005	SDK-5	
5893 006	SDK-6	

5902	Test Print	
	<p>Prints the test pattern that you selected with SP5-902-003.</p> <p>Press [EXECUTE] to execute.</p>	
5902 001	1 Sheet Test	Prints one test pattern.
5902 002	Cont Test	Prints consecutive copies of the test pattern
5902 003	Test Pattern	<p>Selects a printer test pattern.</p> <p>Use SP5-902 to print either one test pattern (SP5-902-001) or more than one pattern. (SP5-902-002).</p> <p>[0 to 30 / 0 / 1]</p>

	Patterns:
	0: None
	1: Vertical Line (1 dot)
	2: Vertical Line (2dot)
	3: Horizontal Line (1 dot)
	4: Horizontal Line (2dot)
	5: Grid Vertical Line
	6: Grid Horizontal Line
	7: Grid Pattern Small
	8: Grid Pattern Large
	9: Argyle Pattern Small
	10: Argyle Pattern Large
	11: Independent Pattern (1 dot)
	12: Independent Pattern (2dot)
	13: Independent Pattern (4dot)
	14: Trimming Area
	15: Hound's Tooth Check (Vertical)
	16: Hound's Tooth Check (Horizontal)
	17: Band (Horizontal)
	18: Band (Vertical)
	19: Checker Flag Pattern
	20: Density Pattern

21: Full Dot Pattern
22: Full White Pattern
23: Grayscale (Horizontal Margin)
24: Grayscale White(Horizontal Margin)
25: Grayscale (Vertical Margin)
26: Grayscale White (Vertical Margin)
27: Grayscale
28: Grayscale White
29: Grayscale (Cross Margin)
30: Grayscale White (Cross Margin)

5907	Plug & Play	
5907 001	Plug & Play	<p>Sets the brand name and the production name for Windows Plug & Play. This information is stored in NVRAM. If the NVRAM is defective or has been replaced, these names should be registered again.</p> <p>To set the plug and play model name, enter the model number, and then press [#].</p>

5930	Meter Click Charge	
5930 001	Setting	<p>Switches the meter-click charge mode on and off.</p> <p>[0 to 1 / 0 / 1]</p> <p>0: No</p> <p>1: Yes</p>

	<p>★ Important</p> <ul style="list-style-type: none"> • Turn the main switch off/on after changing this setting. • No: Meter charge mode disabled (default). • This setting is for machines where the operator is responsible for replacing the AIO and the Maintenance Kit. • Alert messages are displayed on the operation panel when the AIO or PM parts reach the limit of their yield. • The PM counter resets automatically after the user replaces the fusing unit. • Yes: Meter charge mode enabled. • This setting is for machines where the service technician has responsibility for servicing the machine. • Alert messages are not displayed when the AIO or PM parts reach the limits of their yield. • Pressing the [Menu] button displays the meter charge count. • The service technician must reset the PM counter after completing machine maintenance. 	
5930 002	Life Disp:Maintenance Kit	Displays the maintenance kit near end notification [0 to 1 / 1 / 1]
5930 003	Life Disp:AIO	Displays the AIO cartridge near end notification [0 to 1 / 1 / 1]

5990	SP Print Mode	
5990 001	All	Prints the summary sheet for the item selected. Press [EXECUTE] to execute.
5990 002	SP	
5990 004	Logging Data	
5990 005	Diagnostic Report	
5990 006	Non-Default	
5990 007	NIB Summary	
5990 024	SDK/J Summary	
5990 025	SDK/J Appli. Info	

5997	PSC	
	Sets the PSC.	
5997 001	COMMAND	[0 to 3 / 2 / 1]
5997 002	DOMAIN_IF	[0 to 3 / 0 / 1]
5997 003	RAPI	[0 to 3 / 0 / 1]
5997 004	PRINT	[0 to 3 / 0 / 1]
5997 005	ENGINE	[0 to 3 / 0 / 1]
5997 006	THREAD	[0 to 3 / 0 / 1]
5997 007	THREAD_OBJ	[0 to 3 / 0 / 1]
5997 008	STS_TREE	[0 to 3 / 0 / 1]
5997 009	TREE_INIT	[0 to 3 / 0 / 1]
5997 010	EVENT	[0 to 3 / 0 / 1]
5997 011	SP	[0 to 3 / 0 / 1]
5997 012	OTHER	[0 to 3 / 0 / 1]
5997 013	MEMORY	[0 to 3 / 0 / 1]

SP7-xxx: Data Log

7001	Operation Time	
7001 001	Operation Time	<p>Displays the total number of engine rotation cycles made so far.</p> <p>[0 to 999999999 / 0 / 1]</p> <p>Note</p> <ul style="list-style-type: none"> • One cycle is calculated as 2.4 seconds of drum rotation. • However, this counter also includes idle rotations. • This counter is not reset at PM.

7401	Total SC Counter	
7401 001	Total SC Counter	Displays the total number of service calls that have occurred. [0000 to 9999 / 0 / 1]

7403	SC History	
7403 001	Latest	Displays the most recent service calls successive groups of 10.
7403 002	Latest 1	
7403 003	Latest 2	
7403 004	Latest 3	
7403 005	Latest 4	
7403 006	Latest 5	
7403 007	Latest 6	
7403 008	Latest 7	
7403 009	Latest 8	
7403 010	Latest 9	

7404	SC991 History	
-------------	---------------	--

7404 001	Latest	Displays the most recent SC991 successive groups of 10.
7404 002	Latest 1	
7404 003	Latest 2	
7404 004	Latest 3	
7404 005	Latest 4	
7404 006	Latest 5	
7404 007	Latest 6	
7404 008	Latest 7	
7404 009	Latest 8	
7404 010	Latest 9	

7502	Counter-Paper Jam	
7502 001	Counter-Paper Jam	Displays the total number of jams. [0000 to 9999 / 0 / 1]

7504	Paper Jam Loc	
	Displays the total number of jams by location. A "Paper Late" error occurs when the paper fails to activate the sensor at the precise time. A "Paper Lag" paper jam occurs when the paper remains at the sensor for longer than the prescribed time. [0000 to 9999 / 0 / 1]	
Error No.	Error	
001	At Power On	
003	Tray 1: On	
004	Tray 2: On	
005	Tray 3: On	
006	Tray 4: On	
007	Tray 5: On	

008	Bypass: On
009	Duplex: On
013	V-Transport 2: On
014	V-Transport 3: On
015	V-Transport 4: On
017	Regist Sn: On
020	Paper Exit: On
023	Inverter Sn: On
027	Duplex Relay: On
053	P-Feed 2: Off
054	P-Feed 3: Off
055	P-Feed 4: Off
056	P-Feed 5: Off
057	Regist Sn: Off
060	Paper Exit: Off
063	Inverter Sn: Off
067	Duplex Relay: Off
7506	Paper Jam/Size

7506 006	A5 LEF	Displays the total number of jams by paper size
7506 044	HLT LEF	
7506 133	A4 SEF	
7506 134	A5 SEF	
7506 142	B5 SEF	
7506 164	LG SEF	
7506 166	LT SEF	
7506 172	HLT SEF	
7506 255	Other	

5

7507	Dsply-P Jam Hist	
	<p>Displays the copy jam history in groups of 10, starting with the most recent 10 jams. Display contents are as follows:</p> <p>CODE is the SP7-504-<i>nnn</i> number.</p> <p>SIZE is the ASAP paper size (hexadecimal value, see below table).</p> <p>TOTAL is the total jam error count (SP7-502)</p> <p>DATE is the date the jams occurred (MMM DD HH:MM:SS YYYY).</p>	
7507 001	Latest	<p>Sample Display:</p> <p>CODE: 007</p> <p>SIZE: 06</p> <p>TOTAL: 0000334</p> <p>DATE: Feb 18 02:45:48 2011</p>
7507 002	Latest 1	
7507 003	Latest 2	
7507 004	Latest 3	
7507 005	Latest 4	
7507 006	Latest 5	
7507 007	Latest 6	
7507 008	Latest 7	
7507 009	Latest 8	
7507 010	Latest 9	

Paper Size	Code (hex)	Paper Size	Code (hex)
A5 LEF	06	B5 SEF	8E
B5 LEF	0E	DLT SEF	A0
LT LEF	26	LG SEF	A4
HLT LEF	2C	LT SEF	A6
A4 SEF	85	Others	FF
A5 SEF	86		

5

7801	ROM Info Display	
	Displays the ROM Information.	
7801 002	P/#: Engine	Engine Parts number
7801 009	P/#: PFU1	Parts Number, Standard Paper Tray
7801 019	P/#: PFU2	Parts Number, 1st Optional Paper Tray
7801 040	P/#: PFU3	Parts Number, 2nd Optional Paper Tray
7801 041	P/#: PFU4	Parts Number, 3rd Optional Paper Tray
7801 102	Version: Engine	Version, Engine
7801 109	Version: PFU1	Version, Standard Paper Tray
7801 119	Version: PFU2	Version, 1st Optional Paper Tray
7801 140	Version: PFU3	Version, 2nd Optional Paper Tray
7801 141	Version: PFU4	Version, 3rd Optional Paper Tray
7801 255	Memory/Version/PN	Displays a list of ROM and Software version that can be got in SP-7910 and SP-7911.

7803	PM Counter	
7803 001	Paper	Displays the PM counter. This is not a page counter. It estimates the page count using the engine rotation cycle count. It counts up one page when the engine has made the average number of rotations that is required for one page of a three-page job.

7803 002	Fusing Unit: Pages	Fusing Unit Page numbers [0 to 99999999 / 0 / 1]
7803 003	Fusing Unit: Dist	Fusing Unit Distance [0 to 99999999 / 0 / 1 mm]
7803 004	Fusing Unit: Rate	Fusing Unit used rate [0 to 255 / 0 / 1 %]
7803 005	Trans Rol:Pages	Transfer Roller Page numbers [0 to 99999999 / 0 / 1]
7803 006	Trans Rol:Dist	Transfer Roller Distance [0 to 99999999 / 0 / 1 mm]
7803 007	Trans Rol:Rate	Transfer Roller used rate [0 to 255 / 0 / 1 %]
7803 008	Feed Rol: Pages	Feed Roller Page numbers [0 to 99999999 / 0 / 1]
7803 010	Feed Rol: Rate	Feed Roller used rate [0 to 255 / 0 / 1 %]

7804	PM Count.Reset	
	Resets the PM counter. To reset, press [#Enter].	
7804 001	Paper	Clears the Paper counter
7804 002	All	Clears the all PM counters
7804 003	Fusing Unit	Clears the Fusing unit counter
7804 004	Transfer Roller	Clears the Transfer Roller counter
7804 005	Paper Feed Roller	Clears the Feed Roller counter

7807	Reset-SC/Jam	
-------------	--------------	--

7807 001	Reset-SC/Jam	Resets the SC and jam counters. To reset, press [#Enter]. Note <ul style="list-style-type: none"> This SP does not reset the jam history counter: SP7-507
----------	--------------	---

7832	Display-Self-Diag	
7832 001	Display-Self-Diag	Press [OK] to display a list of error codes. Nothing is displayed if no errors have occurred.

7836	Resident Memory	
7836 001	Resident Memory	Displays the memory capacity of the controller system.

7901	Assert Info.	
7901 001	File Name	Records the location where a problem is detected in the program. The data stored in this SP is used for problem analysis.
7901 002	Number of Lines	
7901 003	Location	

7904	Near End Timing	
7904-001	Maintenance Kit	Sets the Near End Timing of the Maintenance Kit. [0 to 2 / 1 / 1]

7931	AIO Information	
	Displays information about the AIO. <ul style="list-style-type: none"> Returns a value of "0" if the number stored in the cartridge is not recognized. This is information on the AIO ID Chip so if the AIO is not installed, if the AIO is not set properly, or if the front door is open, no value will be displayed because the machine cannot communicate with the AIO. 	
7931 001	Machine ID	Identification number of the machine (Model Name) [0x00 to 0xFF / 0x00 / 0x01]



7931 002	Version	Cartridge version number [0x00 to 0xFF / 0x00 / 0x01]
7931 003	Brand ID	Displays the OEM brand [0x00 to 0xFF / 0x00 / 0x01] 1: Ricoh
7931 004	Area ID	Displays the area ID [0x00 to 0xFF / 0x00 / 0x01] 1: DOM (Japan) 2: NA (North America) 3: EU (Europe) 4: Asia
7931 005	Class ID	Displays the part code number [0x00 to 0xFF / 0x00 / 0x01] 1: 6K 3: 15K
7931 006	Color ID	Displays "0" for the color of the toner (Black), this is the only setting for this machine. [0x00 to 0xFF / 0x00 / 0x01]
7931 007	Maintenance ID	Displays the maintenance ID [0x00 to 0xFF / 0x00 / 0x01] 1: Printer (no maintenance contract) 3: Accessories
7931 008	New AIO	Displays the conditions of AIO [0 to 100 / 0 / 1] 0: Normal 64: New AIO
7931 009	Recycle Count	Displays the recycle count of AIO [0 to 255 / 0 / 1]
7931 010	EDP Code	Displays the toner order code, the code is a string of ASCII characters. Default: 6

7931 011	Serial No.	<p>Displays an ASCII string that identifies the manufacturer</p> <p>Default: 16</p> <p> Note</p> <ul style="list-style-type: none"> • This data is originally entered as BCD and changes into a 16-character string in order to convert it to ASCII. • However, only 10 bytes can be used to communicate with the controller, so the 16 bytes are truncated to 10 bytes.
7931 012	Remaining Toner	<p>Displays "0" to "100" (the percentage of toner remaining in the cartridge)</p> <p>[0 to 100 / 0 / 20]</p>
7931 013	Toner End	<p>N: Toner near end</p> <p>E: Toner end</p> <p>Default: 1</p>
7931 014	Refill Flag	<p>Displays "RF" when the cartridge requires refilling</p> <p>Default: 2</p>
7931 015	R:Total Counter	<p>Displays a number in the range "0" to "99999999", this is the total count at time of installation.</p> <p>[0 to 99999999 / 0 / 1]</p>
7931 016	E:Total Counter	<p>Displays a number in the range "0" to "99999999", this is the total count at toner end.</p> <p>[0 to 99999999 / 0 / 1]</p>
7931 017	Unit Counter	<p>Displays a number in the range "0" to "99999999", this is the total number of pages output by the AIO unit. Counter adds once for each sheet output.</p> <p>[0 to 99999999 / 0 / 1]</p>
7931 018	Install Date	<p>Displays Year-Month-Date of installation for the AIO unit, this setting updates automatically through a serial interface with the machine when the new unit is installed.</p> <p>Default: 8</p>

7931 019	Toner End Date	Displays Year-Month-Date when toner end occurred. Default: 8
7931 020	Conductor Time1	Displays a number in the range "0" to "99999999", this is the count for OPC. [0 to 99999999 / 0 / 1] Note <ul style="list-style-type: none"> This information resides at four locations (020, 021, 022, 023). The recycle count determines where the value is written. The counter increments by "1" for every 6 sec. of drum rotation time. To calculate the actual time in sec., multiply the displayed value by 6.
7931 021	Conductor Time2	
7931 022	Conductor Time3	
7931 023	Conductor Time4	

7941	AIO Info: Log	
	Displays information about the AIO log. <ul style="list-style-type: none"> Returns a value of "0" if the number stored in the cartridge is not recognized. This is information on the AIO ID Chip so if the AIO was not installed, if the AIO was not set properly, or if the front door was open, no value would be logged because the machine could not communicate with the AIO. 	
7941 001	Log1: Serial No.	Displays an ASCII string in the Log 1, that identifies the manufacturer Default: 16 Note <ul style="list-style-type: none"> This data is originally entered as BCD and changes into a 16-character string in order to convert it to ASCII. However, only 10 bytes can be used to communicate with the controller, so the 16 bytes are truncated to 10 bytes.
7941 002	Log1: Refill Flag	Displays "RF" when the cartridge requires refilling Cartridge version number in the Log 1 Default: 2

7941 003	Log1: Install Date	Displays Year-Month-Date of installation for the AIO unit in the Log1, this setting updates automatically through a serial interface with the machine when the new unit is installed Default: 8
7941 004	Log1: R: TCounter	Displays a logged number in the range "0" to "99999999" in the Log1. this is the total count at time of installation [0 to 99999999 / 0 / 1]
7941 005	Log2: Serial No.	Displays an ASCII string in the Log2, that identifies the manufacturer Default: 16 Note <ul style="list-style-type: none"> This data is originally entered as BCD and changes into a 16-character string in order to convert it to ASCII. However, only 10 bytes can be used to communicate with the controller, so the 16 bytes are truncated to 10 bytes.
7941 006	Log2: Refill Flag	Displays "RF" when the cartridge requires refilling Cartridge version number in the Log2 Default: 2
7941 007	Log2: Install Date	Displays Year-Month-Date of installation for the AIO unit in the Log2, this setting updates automatically through a serial interface with the machine when the new unit is installed Default: 8
7941 008	Log2: R: TCounter	Displays a logged number in the range "0" to "99999999" in the Log2, this is the total count at time of installation [0 to 99999999 / 0 / 1]

7941 009	Log3: Serial No.	<p>Displays an ASCII string in the Log3, that identifies the manufacturer.</p> <p>Default: 16</p> <p> Note</p> <ul style="list-style-type: none"> • This data is originally entered as BCD and changes into a 16-character string in order to convert it to ASCII. • However, only 10 bytes can be used to communicate with the controller, so the 16 bytes are truncated to 10 bytes.
7941 010	Log3: Refill Flag	<p>Displays "RF" when the cartridge requires refilling Cartridge version number in the Log3</p> <p>Default: 2</p>
7941 011	Log3: Install Date	<p>Displays Year-Month-Date of installation for the AIO unit in the Log3, this setting updates automatically through a serial interface with the machine when the new unit is installed</p> <p>Default: 8</p>
7941 012	Log3: R: TCounter	<p>Displays a logged number in the range "0" to "99999999" in the Log3, this is the total count at time of installation</p> <p>[0 to 99999999 / 0 / 1]</p>
7941 013	Log4: Serial No.	<p>Displays an ASCII string in the Log4, that identifies the manufacturer</p> <p>Default: 16</p> <p> Note</p> <ul style="list-style-type: none"> • This data is originally entered as BCD and changes into a 16-character string in order to convert it to ASCII. • However, only 10 bytes can be used to communicate with the controller, so the 16 bytes are truncated to 10 bytes.
7941 014	Log4: Refill Flag	<p>Displays "RF" when the cartridge requires refilling Cartridge version number in the Log4</p> <p>Default: 2</p>

5

7941 015	Log4: Install Date	Displays Year-Month-Date of installation for the AIO unit in the Log4, this setting updates automatically through a serial interface with the machine when the new unit is installed. Default: 8
7941 016	Log4: R: TCounter	Displays a logged number in the range "0" to "99999999" in the Log4, this is the total count at toner end [0 to 99999999 / 0 / 1]
7941 017	Log5: Serial No.	Displays an ASCII string in the Log5, that identifies the manufacturer Default: 16 Note <ul style="list-style-type: none"> This data is originally entered as BCD and changes into a 16-character string in order to convert it to ASCII. However, only 10 bytes can be used to communicate with the controller, so the 16 bytes are truncated to 10 bytes.
7941 018	Log5: Refill Flag	Displays "RF" when the cartridge requires refilling. Cartridge version number in the Log5 Default: 2
7941 019	Log5: Install Date	Displays Year-Month-Date of installation for the AIO unit in the Log5, this setting updates automatically through a serial interface with the machine when the new unit is installed. Default: 8
7941 020	Log5: R: TCounter	Displays a logged number in the range "0" to "99999999" in the Log5, this is the total count at toner end. [0 to 99999999 / 0 / 1]
7993	Total counter (Engine)	

7993 001	Total counter	Displays the engine total counter. It counts up for all prints, including service reports. [0 to 99999999 / 0 / 1]
----------	---------------	---

SP8XXX: Data Log 2

The SPs in this group are prefixed with a letter that indicates the mode of operation. The mode of operation is referred to as an 'application'. Before reading the Group 8 Service Tables, make sure that you understand what these prefixes mean.

Prefix	Application	What It Means
T:	Total	Grand total of the items counted for all applications (C, F, P, etc.).
P:	Print	Totals (pages, jobs, etc.) executed for each application when the job was not stored on the document server.
O:	Other	Other applications (external network applications, etc.). Refers to network applications such as Web Image Monitor. Utilities developed with the SDK (Software Development Kit) are also counted.

5

Group 8 SP codes are limited to 17 characters, forced by the necessity of displaying them on the small LCDs of printers and faxes that also use these SPs.

↓ Note

- All of the Group 8 SPs are reset with SP5801-001 Memory All Clear.

8381	T:Total PrtPGS	These SPs count the number of pages printed by the customer. The counter for the application used for storing the pages increments. [0 to 99999999/0/1]
8381 001	Field Number	
8384	P:Total PrtPGS	
8384 001	Field Number	
8387	O:Total PrtPGS	
8387 001	Field Number	

- When the A3/DLT double count function is switched on with SP5104, 1 A3/DLT page is counted as 2.
- When several documents are merged for a print job, the number of pages stored are counted for the application that stored them.

- These counters are used primarily to calculate charges on use of the machine, so the following pages are not counted as printed pages:
- Blank pages in a duplex printing job.
- Reports printed to confirm counts.
- All reports done in the service mode (service summaries, engine maintenance reports, etc.)
- Test prints for machine image adjustment.
- Error notification reports.
- Partially printed pages as the result of a jam.

8391	LSize PrtPGS	
8391 001	A3/DLT, Larger	These SPs count pages printed on paper sizes A3/DLT and larger. [0 to 99999999/0/1]

8411	Prints/Duplex	
8411 001	Prints/Duplex	This SP counts the amount of paper (front/back counted as 1 page) used for duplex printing. Last pages printed only on one side are not counted. [0 to 99999999/0/1]

8421	T:PrtPGS/Dup Comb	
	These SPs count by binding and combine, and n-Up settings the number of pages processed for printing. This is the total for all applications. [0 to 99999999/0/1]	
8424	P:PrtPGS/Dup Comb	
	These SPs count by binding and combine, and n-Up settings the number of pages processed for printing by the printer application. [0 to 99999999/0/1]	
8427	O:PrtPGS/Dup Comb	
	These SPs count by binding and combine, and n-Up settings the number of pages processed for printing by Other applications [0 to 99999999/0/1]	
842x 001	Simplex> Duplex	

842x 004	Simplex Combine	
842x 005	Duplex Combine	
842x 006	2>	2 pages on 1 side (2-Up)
842x 007	4>	4 pages on 1 side (4-Up)
842x 008	6>	6 pages on 1 side (6-Up)
842x 009	8>	8 pages on 1 side (8-Up)
842x 010	9>	9 pages on 1 side (9-Up)
842x 011	16>	16 pages on 1 side (16-Up)
842x 012	Booklet	
842x 013	Magazine	

- These counts are especially useful for customers who need to improve their compliance with ISO standards for the reduction of paper consumption.
- Pages that are only partially printed with the n-Up functions are counted as 1 page.

8441	T:PrtPGS/Ppr Size
	These SPs count by print paper size the number of pages printed by all applications. [0 to 99999999/0/1]
8444	P:PrtPGS/Ppr Size
	These SPs count by print paper size the number of pages printed by the printer application. [0 to 99999999/0/1]
8447	O:PrtPGS/Ppr Size
	These SPs count by print paper size the number of pages printed by Other applications. [0 to 99999999/0/1]

844x 001	A3	
844x 002	A4	
844x 003	A5	
844x 004	B4	
844x 005	B5	
844x 006	DLT	
844x 007	LG	
844x 008	LT	
844x 009	HLT	
844x 010	Full Bleed	
844x 254	Other (Standard)	
844x 255	Other (Custom)	

- These counters do not distinguish between LEF and SEF.

8451	PrtPGS/Ppr Tray	
	These SPs count the number of sheets fed from each paper feed station. [0 to 99999999/0/1]	
8451 001	Bypass Tray	Bypass Tray
8451 002	Tray 1	Main Machine
8451 003	Tray 2	Paper Tray Unit (Option)
8451 004	Tray 3	Paper Tray Unit (Option)

8451 005	Tray 4	Currently not used.
8451 006	Tray 5	
8451 007	Tray 6	
8451 008	Tray 7	
8451 009	Tray 8	
8451 010	Tray 9	
8451 011	Tray 10	
8451 012	Tray 11	
8451 013	Tray 12	
8451 014	Tray 13	
8451 015	Tray 14	
8451 016	Tray 15	

8461	T:PrtPGS/Ppr Type
	<p>[0 to 99999999/0/1]</p> <p>These SPs count by paper type the number pages printed by all applications.</p> <ul style="list-style-type: none"> • These counters are not the same as the PM counter. The PM counter is based on feed timing to accurately measure the service life of the feed rollers. These counts are based on output timing. • Blank sheets (covers, chapter covers, slip sheets) are also counted. • During duplex printing, pages printed on both sides count as 1, and a page printed on one side counts as 1.
8464	P:PrtPGS/Ppr Type
	These SPs count by paper type the number pages printed by the printer application.
846x 001	Normal
846x 002	Recycled
846x 003	Special
846x 004	Thick

846x 005	Normal (Back)
846x 006	Thick (Back)
846x 007	OHP
846x 008	Other

8521	T:PrtPGS/FIN
	[0 to 999999999/0/1] These SPs count by finishing mode the total number of pages printed by all applications.
8524	P:PrtPGS/FIN
	These SPs count by finishing mode the total number of pages printed by the Print application. [0 to 999999999/0/1]
852x 001	Sort
852x 002	Stack
852x 003	Staple
852x 004	Booklet
852x 005	Z-Fold
852x 006	Punch
852x 007	Other
852x 008	Inside-Fold
852x 009	Three-IN-Fold
852x 010	Three-OUT-Fold
852x 011	Four-Fold
852x 012	KANNON-Fold
852x 013	Perfect-Bind
852x 014	Ring-Bind

- If stapling is selected for finishing and the stack is too large for stapling, the unstapled pages are still counted.
- The counts for staple finishing are based on output to the staple tray, so jam recoveries are counted.

8551*1	T:FIN Books	
	[0 to 999999999/0/1]	
8554*1	P:FIN Books	
	[0 to 999999999/0/1]	
855x 001	Perfect-Bind	
855x 002	Ring-Bind	

5

8581	T:Counter	
8581 001	Total	<p>These SPs count the total output broken down by color output, regardless of the application used. In addition to being displayed in the SMC Report, these counters are also displayed</p> <p>[0 to 999999999/0/1]</p>

8591	O:Counter	
	<p>These SPs count the totals for A3/DLT paper used, number of duplex pages printed, and the number of staples used. These totals are for Other (O:) applications only.</p> <p>[0 to 999999999/0/1]</p>	
8591 001	A3/DLT	
8591 002	Duplex	

8601	CvgCounter	
	These counts correspond to the total counts recorded with the mechanical counter.	
8601 001	Cvg: BW %	Coverage: BW Pages
8601 011	Cvg: BW Pages	Coverage: BW Percent

8617	SDK Apli Counter	*CTL	[0 to 9999999/ 0 / 1]
	These SPs count the total printout pages for each SDK applicaion.		
8617 001	SDK-1	-	
8617 002	SDK-2		
8617 003	SDK-3		
8617 004	SDK-4		
8617 005	SDK-5		
8617 006	SDK-6		

5

8621	Func Use Counter DFU		
	This SP counts the number of development roller rotations for development. [0 to 99999999/0/1]		
001 to 64	Function-001 to -064		

8771	Dev Counter		
8771 001	Total	This SP counts the number of development roller rotations for development. [0 to 99999999/0/1]	

8781	Toner_Botol_Info.		
8781 001	BK	RTB 47 Modified	This SP displays the count for the number of toner bottles used. The count is done based on the assumption that one toner bottle yields about 1,000 printed pages.

8801	Toner Remain		
8801 001	K	This SP displays (as a percentage) the amount of toner remaining. This precise method of measuring remaining toner supply (1% steps) is better than other machines in the market that can only measure in increments of 10 (10% steps). [0 to 100/0/1]	

8851	Cvr Cnt:0-10%	
	These SPs count the percentage of dot coverage for K toner. [0 to 999999999]	
8851 011	0~2%:BK	
8851 021	3~4%:BK	
8851 031	5~7%:BK	
8851 041	8~10%:BK	

8861	Cvr Cnt:11-20%	
8861 001	BK	This SP counts the number of prints that had a percentage of black dot coverage in the range 11-20%. [0 to 999999999]

8871	Cvr Cnt:21-30%	
8871 001	BK	This SP counts the number of prints that had a percentage of black dot coverage in the range 21-30%. [0 to 999999999]

8881	Cvr Cnt: 31%-	
8881 001	BK	This SP counts the number of prints that had a percentage of black dot coverage in the range above 31%. [0 to 999999999]

8891	Page/Toner Bottle	
8891 001	BK	
8901	Page/Ink_Prev 1	
8901 001	BK	
8911	Page/Ink_Prev 1	

8911 001	BK	
----------	----	--

8921	Cvr Cnt/Total	
	These counters count the percentage of dot coverage for K toner. (This machine uses only black toner)	
8921 001	Coverage (%):BK	
8921 011	Coverage/P:BK	

8941	Machine Status	
	These SPs count the amount of time the machine spends in each operation mode. These SPs are useful for customers who need to investigate machine operation for improvement in their compliance with ISO Standards. [0 to 99999999/0/1]	
8941 001	Operation Time	Engine operation time. Does not include time while controller is saving data to HDD (while engine is not operating).
8941 002	Standby Time	Engine not operating. Includes time while controller saves data to HDD. Does not include time spent in Energy Save mode.
8941 003	Energy Save Time	Includes time while the machine is performing background printing.
8941 004	Low Power Time	Includes time in Energy Save mode with Engine on. Includes time while machine is performing background printing.
8941 005	Off Mode Time	Includes time while machine is performing background printing. Does not include time machine remains powered off with the power switches.
8941 006	SC	Total down time due to SC errors.
8941 007	PrtJam	Total down time due to paper jams during printing.
8941 008	OrgJam	Total down time due to original paper jams.
8941 009	Supply PM Unit End	Total down time due to toner end.

	AdminCounter	Machine Administration Counter
8999	<p>This SP displays the counts for the items listed below. Use this SP as a quick reference to see the total counts of the corresponding SP codes listed below.</p> <p>Note: This machine supports K printing only, so the counts for 015 and 017 are identical.</p>	
8999 001	Total (SP8381 001)	Total output (sheets fed out)
8999 007	Printer: BW	Total output for black & white
8999 013	Duplex (SP8411 001)	Total output of duplexed sheets
8999 015	Cvg:BW % (SP8601 001)	Total output of K pages
8999 017	Cvg:BW Pages (SP8601 011)	Total output of K pages

* 1 These SPes are shown, however these cannot be used in this machine.

Firmware Update

★ Important

- Never turn off the machine while downloading the firmware.

Type of Firmware

The table lists the firmware programs used by the machine. All the programs can fit on one SD card.

Program	What It Updates
Engine	Printer engine control
Network DocBox	Document server firmware
Printer	Printer feature applications
System	Printer management
Network Support	Network application
RPCS	RPCS printer device driver
Postscript	Postscript printer device driver
PCL	PCL printer device driver
PDF	PDF printer device driver
PJL	PJL printer device driver
Font	Printer fonts
Web	Web application
SDK1	SDK application

Precautions

Handling SD Cards

Observe these precautions when handling SD cards:

- Always turn off the main power switch before you insert or remove an SD card. Data on an SD card can be corrupted if you insert or remove an SD card while the main power switch is on.

- Never turn off the main power switch during downloading.
- Keep SD cards in a safe location. Never store SD cards in locations where they will be exposed to:
 - High temperature, high humidity
 - Direct sunlight
 - Strong vibrations
 - Magnetic fields generated by machines or electronic devices
- Handle SD cards carefully to avoid dropping them, bending, scratching, etc.

Upload/Download

In this service manual, "upload" and "download" have these meanings:

- Upload: Copying data from the printer to the SD card
- Download: Copying data from the SD card to the printer

5

Network Connection

A print job sent to the machine during firmware update will interrupt the procedure. Before you start the firmware update procedure tell the operator:

- The machine must be disconnected from the network.
- The machine cannot be used during firmware update.

Machine Firmware Update

Update programs one at a time. Follow the procedure below to update one program.

1. Prepare a card that contains the required program.
2. If the machine is on, switch it off.

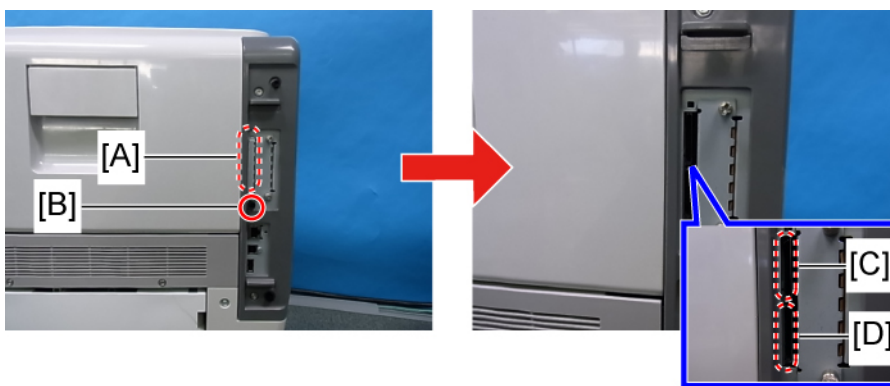

m020r093

3. Remove the SD card cover [A] ( [B] x 1).
4. Insert the SD card into Slot 2 [D] (Lower).
5. Turn on the power. The screen remains blank for about 20 to 30 sec., "Please Wait" appears, then you will see "Engine", the first item available for selection.

Note

- The first selection "Engine" will appear about 1 min. after switching the power on.

6. Scroll to the program to upgrade, then press [#Enter].
7. Press the [Online] to start the upgrade. You will see a series of messages. If you selected "Engine", for example", you would see:

```
ROM Update
*****
```

```
Updating
*****
```

```
Updated
Power Off On
```

The "Power Off On" message appears after about 90 sec.

8. Turn off the power, remove the SD card from Slot 2 [D] (Lower), and turn on the power.
-or-

If you intend to update another program, leave the SD card in Slot 2 [D] (Lower) and turn on the power.

Note

- The firmware has not updated successfully if the "Power Off On" message does not appear. If this occurs, turn the machine power off/on and repeat the procedure.

NVRAM Data Upload/Download

Uploading NVRAM Data

Follow this procedure to upload the NVRAM data to an SD card.

↓ Note

- If the NVRAM data cannot be uploaded successfully before NVRAM replacement, you must manually input the required settings after the NVRAM has been replaced. For this reason, you should always print an SMC report before NVRAM replacement.
1. Enter the SP mode and do SP5990 1 (All) to print the SMC Report.
 2. Exit the SP mode.
 3. Turn off the main power switch.

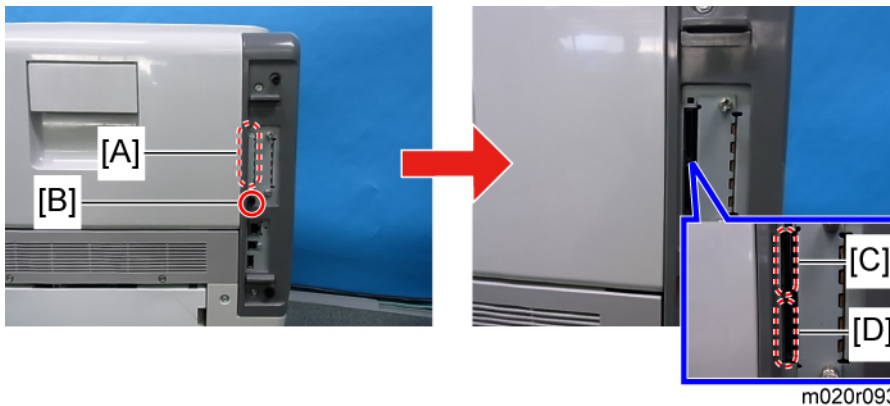

4. Remove the SD card slot cover [A] ( x 1 [B]).
5. Insert an SD card into Slot 2 [D] (Lower).
6. Turn on the main power switch.
7. Enter the SP mode and do SP5824 (NVRAM Upload).
8. Push [#Enter].

```
<NVRAM Upload>
execute?
```

9. Push [#Enter].
10. You will see "Processing". Then when you see "result=OK" the NVRAM data has been uploaded successfully.

This procedure creates an NVRAM folder on the SD card with one file that holds the NVRAM data. The file name is the serial number and the file extension is *.nv.

Example: G1772700016.nv,

11. Exit the SP mode.
12. Turn off the main power switch.
13. Remove the SD card.
14. Mark the SD card with the machine code for later reference. You will need this SD card to download NVRAM to the new NVRAM.

Note

- One SD card can store the NVRAM data of two or more machines.

Downloading NVRAM Data

Follow this procedure to download the data from the SD card to the NVRAM, after the NVRAM has been replaced.

Note

- If the NVRAM data file cannot be downloaded successfully, the settings must be restored manually using the SMC report that was printed before NVRAM uploading.
1. Confirm that the main power switch is off.
 2. Confirm that you have the SD card that contains the proper NVRAM data for the machine.

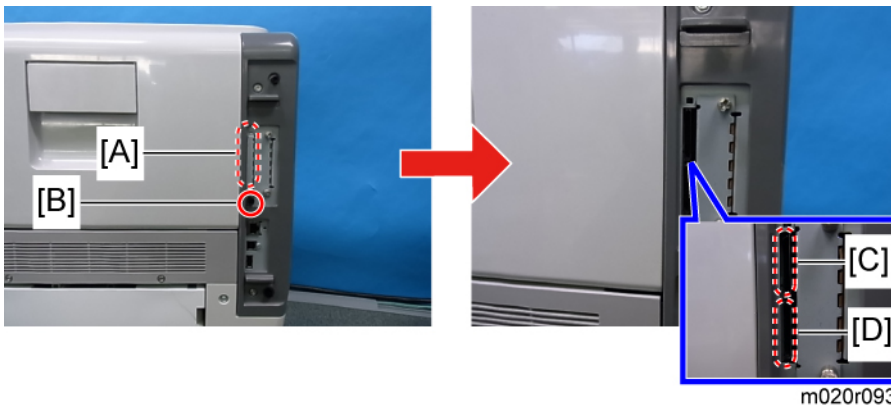

3. Remove the SD card slot cover [A] ( x 1 [B]).
4. Insert the SD card into Slot 2 [D] (Lower).
5. Turn on the main power switch.
6. Enter the SP mode and do SP5825 (NVRAM Download).
7. Push [#Enter].

```
<NVRAM Download>  
execute?
```

8. Push [#Enter].

You will see "Processing". Then when you see "result=OK", the NVRAM data has been downloaded successfully.

Note

- The machine cannot do the download if the file name in the SD card is different from the printer serial number.
9. Exit the SP mode.
 10. Turn off the main power switch.
 11. Remove the SD card.
 12. Turn on the main power switch.

SD Card Application Move

Overview

The service program "SD Card Appli Move" (SP5873) moves application programs from one SD card to another.

Obey these precautions during the SD Card Appli move procedure:

- The authentication data is moved with the application program from an SD card to the other SD card. Authentication fails if you try to use the SD card after you move the application program from this card to another SD card.
- Do not use an SD card if it has been used for some other work, for example, on a computer. Normal operation is not guaranteed when such SD card is used.
- Store the original SD card in a safe location after the procedure. The original SD card cannot be used but it must be saved because (1) the original card is the only proof that the user is licensed to use the application program, and (2) you may need to check the SD card and its data to solve a problem in the future.

5

Move Exec

"Move Exec" (SP5873 1) moves application programs from the original SD card to another SD card. The application programs are moved from Slot 2 [D] to Slot 1 [C].

1. Turn off the main power switch.

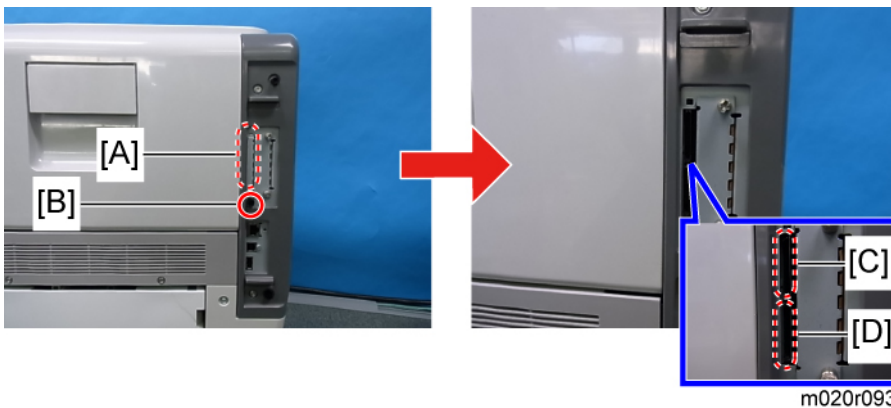

2. Remove the SD card slot cover [A] ( x 1 [B]).
3. Insert the original SD card with the application in Slot 2 [D] (Lower).
4. Insert the SD card to receive the application in Slot 1 [C] (Upper).
5. Turn on the main power switch.

6. Enter the SP mode and do SP5873 1 "Move Exec."
7. Follow the messages on the operation panel to complete the procedure.
8. Exit the SP mode.
9. Turn off the main power switch.
10. Remove the original SD card from Slot 2 [D] (Lower).
11. Leave the other SD card in Slot 1 [C] (Upper).
12. Turn on the main power switch.
13. Confirm that the application program runs normally.
14. Tell the customer to store the original SD card in a safe place.

Undo Exec

"Undo Exec" (SP5873 2) restores an application to its original SD card. The application is moved from Slot 1 [C] (Upper) to Slot 2 [D] (Lower).

5

1. Turn off the main power switch.

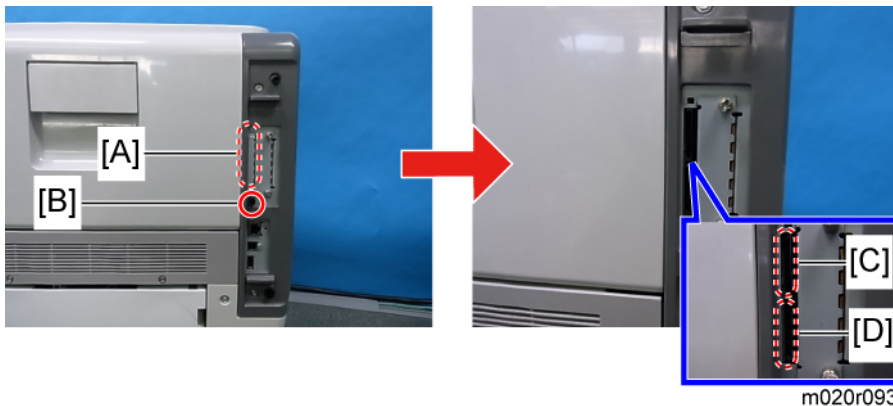

2. Remove the SD card slot cover [A] ( x 1 [B]).
3. Insert the SD card that currently holds the application in Slot 1 [C] (Upper).
4. Insert the original SD card to receive the restored application in Slot 2 [D] (Lower).
5. Turn on the main power switch.
6. Enter the SP mode and do SP5873 "Undo Exec."
7. Follow the messages on the operation panel to complete the procedure.
8. Exit the SP mode.
9. Turn off the main power switch.
10. Remove both SD cards.
11. Insert the SD card with the restored application in Slot 1 [C] (Upper).

12. Turn on the main power switch.
13. Confirm that the application operates normally.

Menu Mode

To enter and use the menu mode:

1. Press [Menu]
2. Press [▼] or [▲] to scroll through the menu listing.
3. Press [OK] to select.
4. To return to the previous level, press [Escape].
5. After changing the settings, press [Menu] to return to standby mode

↓ Note

- The user menu list shown below can be printed: [Menu]> "List/Test Print"> [▼] 5 times> "Menu List"> [OK].
- The Print Jobs items (Sample, Locked, Hold, Stored Print) are not included in the printed list.

Menu Mode Tree

Here is quick summary of the menus.

1st Level	2nd Level
Paper Input	Paper Size: Bypass Tray
	Paper Size: Tray 1
	Paper Size: Tray 2 (Only when installed)
	Paper Size: Tray 3 (Only when installed)
	Paper Size: Tray 4 (Only when installed)
	Paper Size: Tray 5 (Only when installed)
	Paper Type: Bypass Tray
	Paper Type: Tray 1
	Paper Type: Tray 2 (Only when installed)
	Paper Type: Tray 3 (Only when installed)
	Paper Type: Tray 4 (Only when installed)
	Paper Type: Tray 5 (Only when installed)
	Duplex Tray
	Auto Tray Select

1st Level	2nd Level
	Tray Priority
Maintenance	Quality Maintenance
	General Settings
	Timer Settings
	HDD Management
	Machine Settings Export
List/Test Print	Multiple Lists
	Config. Page
	Error Log
	Network Summary
	Supply Info List
	Menu List
	PCL Config./Font Page
	PS Config./Font Page
	PDF Config./Font Page
	Hex Dump
System	Print Error Report
	Auto Continue
	Memory Overflow
	Printer Language
	Sub Paper Size
	Default Printer Lang.
	Auto Off
	Print Compressed Data
	Memory Usage

1st Level	2nd Level
	Spool Printing
	Auto E-Mail Notify
Print Settings	Machine Modes
	PCL Menu
	PS Menu
	PDF Menu
Security Options	Extended Security
	Firmware Version
	Network Security Level
	Auto Erase Memory Setting
	Erase All Memory
	Transfer Log Setting
Host Interface	I/O Buffer
	I/O Timeout
	Network
	USB Settings
Shut Down	(Executes before turning off the power)
Language	(Select 1 of 15 available languages)

Controller Board DIP Switches

The controller board DIP switches must always be set as shown below.

Controller Board Default DIP SW Settings

DIP SW	Setting
1	ON
2	OFF
3	OFF
4	OFF

5

★ Important

- Do not change these settings.

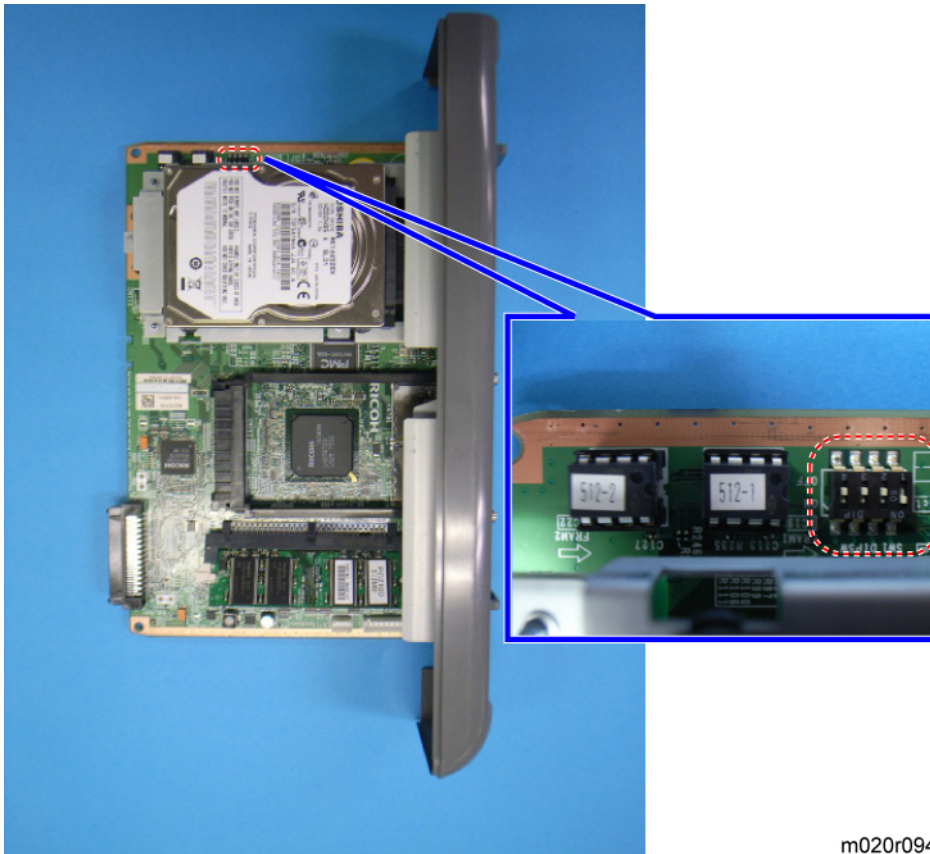

m020r094

Card Save Function

Overview

Card Save:

- The Card Save function is used to save print jobs received by the printer on an SD card with no print output. Card Save mode is toggled using printer Bit Switch #1 bit number 4. Card Save will remain enabled until the SD card becomes full, or until all file names have been used.
- Captures are stored on the SD card in the folder /prt/cardsave. File names are assigned sequentially from PRT00000.prn to PRT99999.prn. An additional file PRT.CTL will be created. This file contains a list of all files created on the card by the card save function.
- Previously stored files on the SD card can be overwritten or left intact. Card Save SD has "Add" and "New" menu items.
 - **Card Save (Add):** Appends files to the SD Card. Does not overwrite existing files. If the card becomes full or if all file names are used, an error will be displayed on the operation panel. Subsequent jobs will not be stored.
 - **Card Save (New):** Overwrites files in the card's /prt/cardsave directory.

Limitation:

- Card Save cannot be used with PjL Status Readback commands. PjL Status Readbacks will not work. In addition they will cause the Card Save to fail.

Procedure

1. Turn the main power switch OFF.

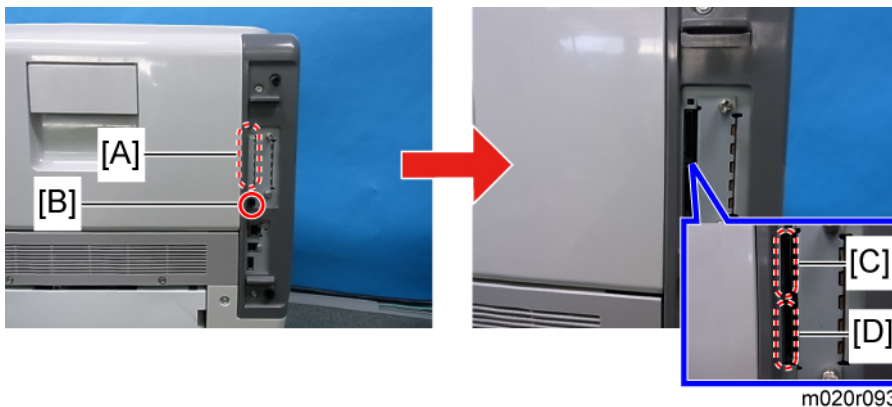

2. Remove the SD card slot cover [A] ( x 1 [B]).

3. Insert the SD card into the service slot 2 [D] (Lower) of the controller board. Then turn the power ON.
4. Enter SP mode.
5. Select "Service" and press "#Enter" button twice.
6. Select "Bit Switch 1" and press "#Enter" button.

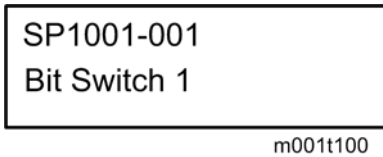

7. Use the arrow keys to select "Bit Switch 4" and press "Enter" and use the arrow keys to turn bit 4 ON. The result should look like: **00010000**. By doing this Card Save option will appear in "List/Test Print".

5

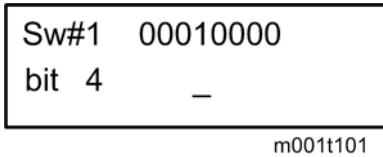

8. Press the "Escape" button several times, and use the arrow keys to select "3 End" to exit SP Mode.
9. Press the "Menu" button.
10. Use the arrow keys and select "List/Test Print".

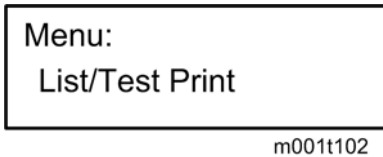

11. Use the arrow keys and select "Card save (ADD)" or "Card save (New)".

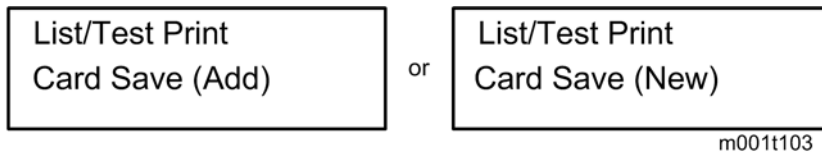

12. To enable the newly configured settings, select "#" button and then press the "Escape" button to exit the "List/Test Print" menu.
13. Send a job to the printer.
14. As soon as the printer receives the data, it will be stored on the SD card automatically with no print output. Nothing is displayed on the screen indicating that a Card Save operation was successful.
15. Press the "Suspend/Resume" button and then the "Escape" button to exit Card Save mode.
16. Change the Bit Switch Settings back to the default **00000000**.

17. Remove the SD card after main power switch is turned off.

6. Troubleshooting

Service Call Conditions

Summary

There are 4 levels of service call conditions

Level	Definition	Reset Procedure
A	Fusing unit SCs shown on the operation panel. The machine is disabled. The user cannot reset the SC.	Do SP5810 and press [#Enter]. When "execute" is displayed, press [#Enter] again. Press [Escape]. Turn the machine power off/on.
B	These SCs disable only the features that use the defective item. The user does not see these SCs in usual conditions. But, they are shown on the operation panel when the defective feature is used.	Set the main power switch to "off" then to "on".
C	SCs that are not shown on the operation panel. They are recorded internally.	Recorded only.
D	These SCs are shown on the operation panel. To reset these SCs, turn the operation switch or main power switch off and on. These SCs are shown again if the error occurs again.	Set the operation switch or the main power switch to "off" then to "on".

↓ Note

- If the problem is with electrical circuit boards, disconnect the connectors first. Then reconnect the connectors before you replace the PCBs.
- If the problem is with a motor lock, first examine the mechanical load. Then replace motors or sensors.

SC Code Descriptions

195	D	Product number error	The input product number (11 digits) is not proper.
		The input product number (11 digits) is not equal to the product identification code.	Enter the product number again. Note <ul style="list-style-type: none"> SC195 is not SC bootable.
202	D	Polygon motor error 1: ON timeout	<ul style="list-style-type: none"> Polygon motor/driver board harness loose or disconnected Polygon motor/driver board defective
		The polygon mirror motor did not reach the targeted operating speed within T1 seconds after turning on or changing speed. * T1 = Time within which polygon rotation should become stable.	<ul style="list-style-type: none"> Turn the Power Switch Off and On. Connect the harness properly. Replace the Polygon motor/driver board.
203	D	Polygon motor error 1: OFF timeout	<ul style="list-style-type: none"> Polygon motor/driver board harness loose or disconnected Polygon motor/driver board defective
		The polygon mirror motor did not leave READY status within 3 seconds after polygon motor switched off.	<ul style="list-style-type: none"> Turn the Power Switch Off and On. Connect the harness properly. Replace the Polygon motor/driver board.
204	D	Polygon motor error 1: XSCRDY signal error	<ul style="list-style-type: none"> Polygon motor/driver board harness loose or disconnected Polygon motor/driver board defective
		The "H" status of XSCRDY signal is detected 4 times consecutively during the writing process.	<ul style="list-style-type: none"> Turn the Power Switch Off and On. Connect the harness properly. Replace the Polygon motor/driver board.

220	D	Laser synchronization detection error: LDO	<ul style="list-style-type: none"> • Disconnected cable from the laser synchronizing detection unit or defective connection • Defective laser synchronizing detector • Laser beam does not go into the photo detector • Defective GAVD • Defective LD Driver • Defective LDB • Defective BCU
		The laser synchronizing detection signal for the start position of the LD is not output within 500 ms after the LDB unit turns on with the polygon motor rotating normally.	
221	D	Laser synchronization detection error: except LDO	<ul style="list-style-type: none"> • Laser beam does not go into the photo detector • Defective GAVD • Defective LD Driver • Defective LDB • Defective BCU
		The laser synchronizing detection signal for the start position of the other LDs are not output within 500 ms after LDB unit turns on with the polygon motor rotating normally.	
230	D	FGATE ON error	<ul style="list-style-type: none"> • Defective GAVD and PCI bridge ASIC • Defective BCU • Defective controller board • Defective harness between BCU and LDB
		The FGATE signal did not assert within 1 second. (The BCU generates the FGATE signal and sends it to the LD unit when the registration sensor switches on.)	

231	D	FGATE OFF error	<ul style="list-style-type: none"> Defective GAVD and PCI bridge ASIC
		The FGATE signal did not go off within 10 seconds after the machine finished writing. (The BCU generates the FGATE signal and sends it to the LD unit when the registration sensor switches on.)	<ul style="list-style-type: none"> Turn the Power Switch Off and On. Replace the controller board.
240	C	LD error	<ul style="list-style-type: none"> Defective LD unit Disconnect harness. Disconnect LD Driver.
		The IPU detected a problem at the LD unit.	<ul style="list-style-type: none"> Connect the harness properly. Replace the LD unit.
312	D	Charge roller current leak	<ul style="list-style-type: none"> Cartridge (charge roller) defective High voltage supply board defective Disconnect harness.
		The PWM duty output exceeded 50% for longer than 200 ms, indicating a leak in the charge roller current.	<ul style="list-style-type: none"> Turn the Power Switch Off and On. Connect the harness properly. Replace the AIO unit. Replace the High voltage power supply board.
320	D	Development Bias leak	<ul style="list-style-type: none"> Bias applying section leak High voltage supply board defective Disconnect harness Development Bias CN loose
		The PWM duty output exceeded 50% for longer than 200 ms, indicating a leak in the charge roller current.	<ul style="list-style-type: none"> Connect the harnesses properly. Replace the AIO. Replace High voltage power supply board.

440	D	Primary Transfer PP output leak	<ul style="list-style-type: none"> • High voltage supply board defective. • Disconnect harness • Development Bias CN loose
		The PWM duty output exceeded 50% for longer than 200 ms, indicating a leak in the charge roller current.	<ul style="list-style-type: none"> • Connect the harnesses properly. • Replace the AIO. • Replace High voltage power supply board.
500	D	Main motor lock	<ul style="list-style-type: none"> • Mechanical overload on the drive mechanism • Main motor defective
		<p>The machine does not detect a main motor lock signal within 1 second after the main motor starts to rotate.</p> <p>-or-</p> <p>The machine does not detect a main motor lock signal for 250 ms continuously while the main motor is rotating.</p>	<ul style="list-style-type: none"> • Remove foreign materials on the drive mechanism. • Turn the Power Switch Off and On. • Connect the harnesses properly. • Replace the main motor.
530	D	Exhaust fan motor error	<ul style="list-style-type: none"> • Mechanical overload on the Exhaust fan mechanism • Exhaust fan harness loose or broken
		The CPU detects an exhaust fan lock signal for more than 2 seconds.	<ul style="list-style-type: none"> • Remove foreign materials on the drive mechanism. • Turn the Power Switch Off and On. • Connect the harnesses properly. • Replace the Exhaust fan.

531	D	Reverse Fan Motor error	<ul style="list-style-type: none"> • Mechanical overload on the Reverse fan mechanism • Reverse fan harness loose or broken
		The CPU detects a Reverse fan lock signal for more than 2 seconds.	
532	D	PSU Fan Motor error	<ul style="list-style-type: none"> • Mechanical overload on the PSU fan mechanism • PSU fan harness loose or broken
		The CPU detects a PSU fan lock signal for more than 2 seconds.	
533	D	PSU2 Fan Motor error	<ul style="list-style-type: none"> • Mechanical overload on the PSU2 fan mechanism • PSU2 fan harness loose or broken
		The CPU detects a PSU2 fan lock signal for more than 2 seconds.	

534	D	AIO Fan Motor error	<ul style="list-style-type: none"> • Mechanical overload on the AIO fan mechanism • AIO fan harness loose or broken
		The CPU detects an AIO fan lock signal for more than 2 seconds.	<ul style="list-style-type: none"> • Remove foreign materials from the AIO fan. • Turn the Power Switch Off and On. • Connect the harnesses properly. • Replace the AIO fan.
541	A	Fusing thermistor error	<ul style="list-style-type: none"> • Thermistor disconnected • Defective thermistor • Fusing unit connected improperly
		The fusing temperature remains lower than 0°C for over 7 seconds after the power relay switches on.	<ul style="list-style-type: none"> • Connect the fusing unit properly. • Connect the thermistor. • Replace the thermistor. <p>Note</p> <ul style="list-style-type: none"> • This SC cannot be reset by turning the power off and on. • This SP should be reset by a CE. • SP5810-01 can reset this SC.
542	A	Fusing temperature warm-up error	<ul style="list-style-type: none"> • Defective thermistor • Thermistor improper installation • Defective fusing lamp
		<p>1: Thermistor detects that the rate of heat increase is less than 7 degrees per 2 seconds consecutively 5 times.</p> <p>2: The fusing temperature did not reach the standby temperature within 24 seconds at the center of the hot roller after the main switch turned on.</p> <p>This SC will appear when condition 1 and 2 occur at the same time.</p>	<ul style="list-style-type: none"> • Install the thermistor properly. • Replace the thermistor. • Replace the fusing lamp. <p>Note</p> <ul style="list-style-type: none"> • This SC cannot be reset by turning the power off and on. • This SP should be reset by a CE. • SP5810-01 can reset this SC.

543	A	Fusing overheat error - software 1	<ul style="list-style-type: none"> Defective Triac Defective IOB Defective engine board
		The detected temperature stays at 235°C for 1 second, and this consecutively occurs 10 times.	<ul style="list-style-type: none"> Replace the Controller board. <p>Note</p> <ul style="list-style-type: none"> This SC cannot be reset by turning the power off and on. This SP should be reset by a CE. SP58 10-01 can reset this SC.

544	A	Fusing overheat error - Hard 1	<ul style="list-style-type: none"> Defective Triac Defective IOB Defective engine board Fusing control error
		The thermistor detects over 250 °C.	<ul style="list-style-type: none"> Replace the Controller board. <p>Note</p> <ul style="list-style-type: none"> This SC cannot be reset by turning the power off and on. This SP should be reset by a CE. SP58 10-01 can reset this SC.

SC545
RTB 25

545	A	Fusing lamp remains on 1	<ul style="list-style-type: none"> Fusing thermistor defective Defective fusing lamp Thermostat actuation
		The fusing lamps remained ON at full capacity for more than 12 seconds after the fusing temperature attains reload temperature.	<ul style="list-style-type: none"> Replace the fusing thermistor. Replace the fusing lamp. Replace the thermostat. <p>Note</p> <ul style="list-style-type: none"> This SC cannot be reset by turning the power off and on. This SP should be reset by a CE. SP58 10-01 can reset this SC.

547	D	Zero cross signal detection error	<ul style="list-style-type: none"> Defective fusing relay Defective fusing relay circuit Shorted +24V fuse on the PSU Unstable AC power AC line noise
		<p>Zero cross signal is detected consecutively 4 times (for 200 ms) at power on with fusing relay being off.</p> <p>-or-</p> <p>Zero cross interrupts did not issue at the prescribed 3 second intervals.</p> <p>-or-</p> <p>The detection error occurs twice or more in 10 zero cross signal detections. This error is defined when the detected zero cross signal is less than 45.</p>	<p>Note</p> <ul style="list-style-type: none"> As for an error due to a high frequency noise interference, this SC will not appear. In this case, SC557 will appear and output the log only.
557	C	Zero cross frequency error	<ul style="list-style-type: none"> AC line noise (High frequency)
		Zero cross signals of wavelength 50-60 Hz were not detected within 5 seconds after the fusing relay switched on.	<p>Note</p> <ul style="list-style-type: none"> No action needed. This SC will perform logging only. The machine will start up normally.
559	A	Fuser 3 times jam error	<ul style="list-style-type: none"> Paper jams at the fusing roller
		<p>The paper jam counter for the fusing unit reaches 3. The paper jam counter is cleared if the paper is fed correctly.</p> <p>This SC is activated only when this function is enabled with "Engine Maintenance" (default "OFF").</p>	<p>Note</p> <ul style="list-style-type: none"> This SC cannot be reset by turning the power off and on. This SP should be reset by a CE. See below note.
		<p>Note</p> <ul style="list-style-type: none"> SP1159 determines whether SC559 is issued. The default is off. SC559 is not issued after three consecutive jams in the paper unit. If SP1159 is set to on, turning the machine power off/on does not reset the jam counter. 	

622	D	Paper tray unit communication error bank 1	<ol style="list-style-type: none"> 1. Disconnect harnesses 2. Defective Paper tray unit 3. Defective engine board 4. External noise
		<p>Three consecutive errors occur during polling, after the paper tray unit has successful I2C communication.</p> <p>Note</p> <ul style="list-style-type: none"> • No paper tray can be used when this SC occurred. 	<ul style="list-style-type: none"> • Turn the Power Switch Off and On. • Connect the harnesses properly. • Replace the Paper tray unit. • Replace the engine board.
623	D	Paper tray unit communication error bank 2	<ol style="list-style-type: none"> 1. Disconnect harnesses 2. Defective Paper tray unit 3. External noise
		<p>Three consecutive errors occur during polling, after the paper tray unit has successful I2C communication.</p> <p>Note</p> <ul style="list-style-type: none"> • No paper tray can be used when this SC occurred. 	<ul style="list-style-type: none"> • Turn the Power Switch Off and On. • Connect the harnesses properly. • Replace the Paper tray unit.
624	D	Paper tray unit communication error bank 3	<ul style="list-style-type: none"> • Disconnect harnesses • Defective Paper tray unit • External noise
		<p>Three consecutive errors occur during polling, after the paper tray unit has successful I2C communication.</p> <p>Note</p> <ul style="list-style-type: none"> • No paper tray can be used when this SC occurred. 	<ul style="list-style-type: none"> • Turn the Power Switch Off and On. • Connect the harnesses properly. • Replace the Paper tray unit.

625	D	Paper tray unit communication error bank 4	<ul style="list-style-type: none"> • Disconnect harnesses • Defective Paper tray unit • External noise
		<p>Three consecutive errors occur during polling, after the paper tray unit has successful I2C communication.</p> <p>Note</p> <ul style="list-style-type: none"> • No paper tray can be used when this SC occurred. 	<ul style="list-style-type: none"> • Turn the Power Switch Off and On. • Connect the harnesses properly. • Replace the Paper tray unit.
641	D	Engine-Controller Communication Error: Non-Response	<ul style="list-style-type: none"> • Engine board defective • Engine board harness loose, broken, defective • External noise
		<p>There was no response to a frame sent from the controller board to the engine.</p> <p>There is still no response after resending frames 3 times in 100 milliseconds</p>	<ol style="list-style-type: none"> 1. Turn the machine power Off and On. 2. Keep away from noise sources. 3. Replace the engine board harness. 4. Replace the engine board.
669	D	EEPROM communication error	<ul style="list-style-type: none"> • External noise • Defective EEPROM
		<p>The EEPROM was not connected at power on, or read/write operations on the EEPROM failed.</p> <p>Retrying 3 times after the error detection cannot recover from the error.</p>	<ul style="list-style-type: none"> • Turn the Power Switch Off and On. • Replace the engine board (Replace the EEPROM).
670	D	Engine startup error	<ul style="list-style-type: none"> • Connections between the engine board and the controller board are loose, disconnected, or damaged
		<p>The engine board fails to respond within 70 seconds when the machine is turned on.</p>	<ol style="list-style-type: none"> 1. Connect the harnesses properly or replace the new one. 2. Replace the engine board. 3. Replace the controller board.

671	D	Illegal engine board detection error	<ul style="list-style-type: none"> Installing another machine's engine board Defective engine board Incorrect NVRAM on the engine board
		The machine code sent from the engine board is incorrect when the machine is turn on.	
681	D	RFID communication error	<ul style="list-style-type: none"> Defective Reader/Writer Disconnect harnesses External noise Defective RFID tag or no ID tag Defective RFID unit
		<ul style="list-style-type: none"> Machine cannot communicate with the RFID. Retrying 3 times after the error detection when communicating with a RF tag cannot recover from the error. 	
683	C	RFID unit check error	<ul style="list-style-type: none"> External noise
		When the unit checking is performed, a transmission error is detected more than 3 times.	<ul style="list-style-type: none"> Reset the AIO unit. Open and close the front cover.
688	D	CTL_PRREQ_N signal does not come.	<ul style="list-style-type: none"> External noise Defective engine board
		The PRREQ signal is not received for 130 seconds after paper reaches the registration waiting point.	
690	D	GAVD communication error	<ul style="list-style-type: none"> Defective GAVD Defective CPU Defective BCU
		The machine detects an error in the data of the ASIC.	

SC672
RTB 17

SC674
RTB 33

790	D	Bank over stacking error	Excess bank stack
		More than 4 PTUs installed.	Decrease the number of PTUs to within 4.

819	D	Fatal kernel error	
		Due to a control error, a RAM overflow occurred during system processing. One of the following messages was displayed on the operation panel.	<ul style="list-style-type: none"> • System program defective • HDD defective • Controller board defective • Optional board defective
			<ol style="list-style-type: none"> 1. Replace the controller firmware. 2. Replace the Controller board. 3. Replace the optional board or HDD.
		0x5032	P2ERRn n= 1 digit arbitrary number that shows which error bit is 'ON'.
		0x6261	bad dir
		0x554C	UL
Other	-		

For more details about this SC code error, execute SP5990 to print an SMC report so you can read the error code. The error code is not displayed on the operation panel.

820	D	Self-Diagnostic Error: CPU	<ul style="list-style-type: none"> • Controller board defective • Software defective
		The central processing unit returned an error during the self-diagnostic test.	<ol style="list-style-type: none"> 1. Replace the software. 2. Replace the controller board.

833	D	Self-diagnostic error 8: Engine I/F ASIC	<ul style="list-style-type: none"> • ASIC (engine board defective)
0F30		ASIC for system control could not be detected. After the PCI configuration, the device ID for the ASIC could not be checked.	<ol style="list-style-type: none"> 1. Replace the engine board.
0F31			
0F41			

833	D	Self-diagnostic error 8: Engine I/F ASIC	<ul style="list-style-type: none"> Loose connection at the engine board ASIC (engine board defective)
50B1		The system control could not initialize or read the bus connection.	<ol style="list-style-type: none"> Check for loose connections at the engine board. Replace the engine board.

833	D	Self-diagnostic error 8: Engine I/F ASIC	<ul style="list-style-type: none"> Loose connection at the engine board ASIC (engine board defective)
50B2		Value of the SSCG register is incorrect.	<ol style="list-style-type: none"> Check for loose connections at the engine board. Replace the engine board.

851	B	IEEE 1394 I/F error	<ul style="list-style-type: none"> NIB (PHY), LINK module defective Controller board defective
		Driver setting incorrect and cannot be used by the 1394 I/F.	<ol style="list-style-type: none"> Change the interface board. Replace the controller board.

853	B	Wireless LAN Error 1	<ul style="list-style-type: none"> Wireless LAN card missing (was removed) Improper installation of the Wireless LAN card
		During machine start-up, the machine can get access to the board that holds the wireless LAN, but not to the wireless LAN card (802.11b or Bluetooth).	<ol style="list-style-type: none"> Turn the power switch Off and On. Install the wireless LAN card properly.

854	B	Wireless LAN Error 2	<ul style="list-style-type: none"> Wireless LAN card missing (was removed) during operation
		During machine operation, the machine can get access to the board that holds the wireless LAN, but not to the wireless LAN card (802.11b or Bluetooth).	<ol style="list-style-type: none"> Once turn off the power, reinstall the wireless LAN card, and then turn on the power. Insert the wireless LAN card firmly.

855	B	Wireless LAN error 3	<ul style="list-style-type: none"> Wireless LAN card defective Wireless LAN card connection incorrect
		An error was detected on the Wireless LAN card (802.11b or Bluetooth).	<ol style="list-style-type: none"> Connect the wireless LAN card correctly. Replace the wireless LAN card.
856	B	Wireless LAN error 4	<ul style="list-style-type: none"> Wireless LAN card defective PCI connector (to the mother board) loose
		An error was detected on the wireless LAN card (802.11b or Bluetooth).	<ol style="list-style-type: none"> Connect the PCI connector firmly. Replace the wireless LAN card.
857	B	USB I/F Error	<ul style="list-style-type: none"> Bad USB card connection Defective controller board
		The USB driver is not stable and caused an error.	<ol style="list-style-type: none"> Connect the USB card correctly. Replace the controller board.
858	A	Data encryption conversion error	<ul style="list-style-type: none"> Key acquisition error
0		A serious error occurred during data encryption.	<ol style="list-style-type: none"> Replace the controller board.
858	A	Data encryption conversion error	<ul style="list-style-type: none"> HDD key setting error
1		A serious error occurred during data encryption.	<ol style="list-style-type: none"> Turn the machine power Off and On. If the error reoccurs, replace the controller board.
858	A	Data encryption conversion error	<ul style="list-style-type: none"> NVRAM read/write error
2		A serious error occurred during data encryption.	<ol style="list-style-type: none"> Replace the NVRAM.

858	A	Data encryption conversion error	<ul style="list-style-type: none"> NVRAM error
30		A serious error occurred during data encryption.	<ol style="list-style-type: none"> Turn the machine power Off and On. If the error reoccurs, replace the controller board.
858	A	Data encryption conversion error	<ul style="list-style-type: none"> Other errors
31		A serious error occurred during data encryption.	<ol style="list-style-type: none"> See SC991.
859	B	HDD data encryption error	<ul style="list-style-type: none"> HDD check error
8		Encryption of data on the hard disk failed..	<ol style="list-style-type: none"> Format the HDD.
859	B	HDD data encryption error	<ul style="list-style-type: none"> Power loss during encryption
9		Encryption of data on the hard disk failed.	<ol style="list-style-type: none"> Format the HDD.
859	B	HDD data encryption error	<ul style="list-style-type: none"> Data read/write error
10		Encryption of data on the hard disk failed.	<ol style="list-style-type: none"> See SC863.
860	B	HDD startup error at main power on	<ul style="list-style-type: none"> HDD is not initialized Level data is corrupted HDD is defective
		HDD is connected but a driver error is detected. The driver does not respond with the status of the HDD within 30 s.	<ol style="list-style-type: none"> Format the HDD. Replace the HDD.

861	D	HDD re-try failure	<ul style="list-style-type: none"> • Harness between HDD and controller board disconnected, defective • HDD power connector disconnected • HDD defective • Controller board defective
		At power on the HDD was detected. Power supply to the HDD was interrupted after the system entered the energy save mode, but after the HDD was awakened from the energy save mode it did not return to the ready status within 30 sec.	<ol style="list-style-type: none"> 1. Turn the machine power Off and On. 2. Connect the HDD and the Controller board properly. 3. Connect the HDD power connector. 4. Replace the HDD. 5. Replace the controller board.
863	D	HDD data read failure	<ul style="list-style-type: none"> • HDD defective <p>Note</p> <ul style="list-style-type: none"> • If the bad sectors are generated at the image partition, the bad sector information is written to NVRAM, and the next time the HDD is accessed, these bad sectors will not be accessed for read/write operation.
		The data written to the HDD cannot be read normally, due to bad sectors generated during operation.	<ol style="list-style-type: none"> 1. Replace the HDD.
864	D	HDD data CRC error	<ul style="list-style-type: none"> • HDD defective
		During HDD operation, the HDD cannot respond to an CRC error query. Data transfer did not execute normally while data was being written to the HDD.	<ol style="list-style-type: none"> 1. Replace the HDD.
865	D	HDD access error	<ul style="list-style-type: none"> • HDD defective.
		HDD responded to an error during operation for a condition other than those for SC863, 864.	<ol style="list-style-type: none"> 1. Replace the HDD.

866	D	SD card error 1: Confirmation	<ul style="list-style-type: none"> • Program missing from the SD card
		The machine detects an electronic license error in the application on the SD card in the controller slot immediately after the machine is turned on. The program on the SD card contains electronic confirmation license data. If the program does not contain this license data, or if the result of the check shows that the license data in the program on the SD card is incorrect, then the checked program cannot execute and this SC code is displayed.	<ol style="list-style-type: none"> 1. Download the correct program for the machine to the SD card.
867	D	SD card error 2: SD card removed	<ul style="list-style-type: none"> • SD card is removed
		The SD card in the boot slot when the machine was turned on was removed while the machine was on.	<ol style="list-style-type: none"> 1. Insert the SD card, then turn the machine off and on.
868	D	SD card error 3: SD card access	<ul style="list-style-type: none"> • SD card not inserted correctly • SD card defective • Controller board defective
		An error occurred while an SD card was used.	<ol style="list-style-type: none"> 1. Insert SD card correctly. 2. Reformat the SD card. <p>Note</p> <ul style="list-style-type: none"> • If you want to try to reformat the SD card, use SD Formatter Ver. 1.1. <ol style="list-style-type: none"> 1. Replace the SD card. 2. Replace the controller board.

870	B	Address book data error	<ul style="list-style-type: none"> HDD defective.
		Address book data on the hard disk was detected as abnormal when it was accessed from either the operation panel or the network. The address book data cannot be read from the HDD or SD card where it is stored, or the data read from the media is defective.	<ol style="list-style-type: none"> Initialize the HDD with SP5832. If this does not solve the problem, replace the HDD and initialize with SP5832. <p>Note</p> <ul style="list-style-type: none"> If you turn off the machine while the HDD is being accessed, this can damage the HDD.
872	B	HDD mail receive data error	<ul style="list-style-type: none"> The machine power was turned off during the HDD access HDD defective.
		<p>The machine detected that the HDD was not operating correctly at power on.</p> <p>The machine detected that the HDD was not operating correctly (could neither read nor write) while processing incoming email</p>	<ol style="list-style-type: none"> Initialize the HDD with SP5832. If this does not solve the problem, replace the HDD and initialize with SP5832. <p>Note</p> <ul style="list-style-type: none"> If you turn off the machine while the HDD is being accessed, this can damage the HDD.
873	B	HDD mail send data error	<ul style="list-style-type: none"> HDD defective.
		An error was detected on the HDD immediately after the machine was turned on, or power was turned off while the machine used the HDD.	<ol style="list-style-type: none"> Initialize the HDD with SP5832. If this does not solve the problem, replace the HDD and initialize with SP5832. <p>Note</p> <ul style="list-style-type: none"> If you turn off the machine while the HDD is being accessed, this can damage the HDD.

874	D	Delete All error 2: Data area	<ul style="list-style-type: none"> The HDD deleting program detected an error An error detected during the NVRAM data or others' deleting processes
		<p>An error occurred while the machine deleted data from the HDD.</p> <p>Note</p> <ul style="list-style-type: none"> The source of this error is the Data Overwrite Security Unit B660 running from an SD card. 	<ol style="list-style-type: none"> Turn the main switch Off and On and try the operation again.
875	D	Delete All error 1: HDD	<ul style="list-style-type: none"> HDD defective
		<p>A data error was detected for the HDD/NVRAM after the Delete All option was used.</p> <p>Note</p> <ul style="list-style-type: none"> The source of this error is the Data Overwrite Security Unit B660 running from an SD card. 	<ol style="list-style-type: none"> Turn the main switch off/on and try the operation again. Install the Data Overwrite Security Unit again. For more, see section "1. Installation".
876	D	Log data abnormal (1)	<ul style="list-style-type: none"> Log data corruption Software error NVRAM defective HDD defective
1		<p>An error was detected in the handling of the log data at power on or during machine operation. This can be caused by switching the machine off while it is operating.</p>	<ol style="list-style-type: none"> Initialize the HDD (See SP5832-004). Update the firmware. Replace the NVRAM. Replace the HDD.

876	D	Log data abnormal (2)	<ul style="list-style-type: none"> • No encryption module when enabling log encryption. • Software error • NVRAM defective • HDD defective
2		An error was detected in the handling of the log data at power on or during machine operation. This can be caused by switching the machine off while it is operating.	<ol style="list-style-type: none"> 1. Disable log encryption. 2. Reset or replace the encryption module. 3. Update the firmware. 4. Replace the NVRAM. 5. Replace the HDD.
876	D	Log data abnormal (3)	<ul style="list-style-type: none"> • Invalid encryption key • Software error • NVRAM defective • HDD defective
3		An error was detected in the handling of the log data at power on or during machine operation. This can be caused by switching the machine off while it is operating.	<ol style="list-style-type: none"> 1. Disable log encryption. 2. Initialize the HDD (See SP5832-004). 3. Update the firmware. 4. Replace the NVRAM. 5. Replace the HDD.
876	D	Log data abnormal (4)	<ul style="list-style-type: none"> • Log data encrypted when disabling encryption • No log data encrypted when enabling the encryption • Software error • NVRAM defective • HDD defective
4		An error was detected in the handling of the log data at power on or during machine operation. This can be caused by switching the machine off while it is operating.	<ol style="list-style-type: none"> 1. Initialize the HDD (See SP5832-004). 2. Update the firmware. 3. Replace the NVRAM. 4. Replace the HDD.

876	D	Log data abnormal (5)	<ul style="list-style-type: none"> • Replacing the NVRAM only • Replacing the HDD only • Software error • NVRAM defective • HDD defective
5		An error was detected in the handling of the log data at power on or during machine operation. This can be caused by switching the machine off while it is operating.	<ol style="list-style-type: none"> 1. Restore the original NVRAM. 2. Restore the original HDD. 3. Initialize the HDD (See SP5832-004). 4. Update the firmware. 5. Replace the NVRAM. 6. Replace the HDD.
876	D	Log data abnormal (99)	<ul style="list-style-type: none"> • Software error • NVRAM defective • HDD defective
99		An error was detected in the handling of the log data at power on or during machine operation. This can be caused by switching the machine off while it is operating.	<ol style="list-style-type: none"> 1. Update the firmware. 2. Replace the NVRAM. 3. Replace the HDD.
877	B	Data Overwrite Security SD card error	<ul style="list-style-type: none"> • SD card defective
		The 'all delete' function did not execute but the Data Overwrite Security Unit (D362) is installed and activated.	<ol style="list-style-type: none"> 1. Insert the SD card correctly. 2. Replace the NVRAM. 3. Reinstall the DOS from the SD card.
878	D	TPM electronic recognition error	<ul style="list-style-type: none"> • Controller board defective
		The main machine firmware failed to recognize TPM because USB flash is not operating or a system module was updated incorrectly.	<ol style="list-style-type: none"> 1. Replace the controller board.

900	D	Electrical total counter error	<ul style="list-style-type: none"> • NVRAM incorrect type • NVRAM defective • NVRAM data scrambled • Unexpected error from external source
		The total counter contains something that is not a number.	1. Replace the NVRAM.
920	B	Printer error 1	<ul style="list-style-type: none"> • Software defective • Insufficient memory
		An internal application error was detected and operation cannot continue.	<ol style="list-style-type: none"> 1. Turn the machine Off and On. 2. Change the Controller firmware.
921	B	Printer error 2	<ul style="list-style-type: none"> • Font not on the SD card
		When the application started, the necessary font was not on the SD card.	1. Copy the necessary font on the SD card.
990	D	Software performance error	<ul style="list-style-type: none"> • Software defective * 1
		The software attempted to perform an unexpected operation due to: <ol style="list-style-type: none"> 1) software bug 2) incorrect internal parameter 3) insufficient working memory 	<ol style="list-style-type: none"> 1. Turn the machine power Off and On. 2. Reinstall the controller and/or main firmware.
991	C	Software continuity error	Software defective * 1
		The software attempted to perform an unexpected operation. However, unlike SC990, the object of the error is continuity of the software.	<ol style="list-style-type: none"> 1. No operation required. <p>Note</p> <ul style="list-style-type: none"> • This SC code does not appear on the panel, and is only logged.

* 1: In order to get more details about SC990 and SC991:

1. Execute SP7403 or print an SMC Report (SP5990) to read the history of the 10 most recent logged errors.

2. If you press the zero key on the operation panel with the SP selection menu displayed, you will see detailed information about the recently logged SC990 or SC991, including the software file name, line number, and so on. 1) is the recommended method, because another SC could write over the information for the previous SC.

992	D	Unexpected Software Error	<ul style="list-style-type: none"> • Software defective • An error undetectable by any other SC code occurred
		Software encountered an unexpected operation not defined under any SC code.	1. Turn the machine Off and On.

995	D	CPM setting error	
01		<ul style="list-style-type: none"> • Defective engine board 	1. Input the serial number with SP5811-004, and turn the main power switch off/on.
02		<ul style="list-style-type: none"> • Defective NVRAM on the controller • Defective controller 	<ol style="list-style-type: none"> 1. Install a new NVRAM, and turn off and on the main power switch after SC995-002 has occurred. 2. Reinstall the previous NVRAM or download the information with SP5825-001, after that turn the main power off and On.
03		<ul style="list-style-type: none"> • Incorrect type controller installed • Defective controller 	1. Replace the controller board with the correct type.
04		<ul style="list-style-type: none"> • Incorrect model controller installed 	1. Replace the controller with the correct model.
		<p>Note</p> <ul style="list-style-type: none"> • SC995 is not SC bootable. 	

998	D	Application start error	<ul style="list-style-type: none">• Loose connection of RAM-DIMM, ROM-DIMM• Software problem• Controller board defective
		No applications start within 60 sec. after the power is turned on.	<ol style="list-style-type: none">1. Check the setting of SP5875-001. If the setting is set to "1 (OFF)", change it to "0 (OFF)".2. Connect the RAM-DIMM, ROM-DIMM correctly.3. Reinstall the controller system firmware.4. Replace the controller board.

Error Messages

Common error messages

Here is a list of common error messages, a description of the problems, and their solutions. This is just a reference information.

1st/2nd Message	Problem/Solution
(A) Remove misfeed in Trays. Opn & cls Frt. Cov.	Paper jam at (A). <ul style="list-style-type: none"> Remove the jammed paper in the source tray, and then load the paper again. To reset the error, open the front cover and then close it.
(B)(C) Open Front/Rear Cover and remove misfeed.	Paper jam at (B) (C) <ul style="list-style-type: none"> Open the front or rear cover, and then remove the jammed paper.
(Y1) Remove misfeed in Tray 2. Opn & cls Frt. Cov.	Paper jam at (Y1) <ul style="list-style-type: none"> Remove the jammed paper in the source tray, and then load the paper again. To reset the error, open the front cover and then close it.
(Y2) Remove misfeed in Tray 3. Opn & cls Frt. Cov.	Paper jam at (Y2) <ul style="list-style-type: none"> Remove the jammed paper in the source tray, and then load the paper again. To reset the error, open the front cover and then close it.
(Y3) Remove misfeed in Tray 4. Opn & cls Frt. Cov.	Paper jam at (Y3) <ul style="list-style-type: none"> Remove the jammed paper in the source tray, and then load the paper again. To reset the error, open the front cover and then close it.
(Y4) Remove misfeed in Tray 5. Opn & cls Frt. Cov.	Paper jam at (Y4) <ul style="list-style-type: none"> Remove the jammed paper in the source tray, and then load the paper again. To reset the error, open the front cover and then close it.
(Z1)(Z2) Opn R.Cov/Tray1 & remove ppr. Opn & cls F.Cov.	Paper jam at (Z1) (Z2) <ul style="list-style-type: none"> Open the rear cover, or remove tray 1 and open the front cover, and then remove the paper.

1st/2nd Message	Problem/Solution
@Remote Cert. update failed	Updating the @Remote certificate failed. <ul style="list-style-type: none"> • Retry updating the @Remote certification.
Cannot connect=>Comm.Serv. Check proxy user/password.	The proxy user name or password is incorrect. <ul style="list-style-type: none"> • Check the proxy server settings, and change the user name and/or password if they are incorrect.
Cannot connect with DHCP server. (101/201)	Cannot obtain IP address from DHCP server. <ul style="list-style-type: none"> • Consult your network administrator.
Cannot connect with NetWare print server. (107/207)	Connection with NetWare print server is unavailable. <ul style="list-style-type: none"> • Consult your network administrator.
Cannot print	Cannot print <ul style="list-style-type: none"> • Check the file you want to print is a supported file type. Check for misfeeds and ask your network administrator for help.
Check network settings.(103/203)	The IP address setting is incorrect. <ul style="list-style-type: none"> • Check the IP address, subnet mask, and gateway address. • Consult your network administrator.
Classification Code Error	A classification code is not specified for the print job. <ul style="list-style-type: none"> • Enter a classification code using the printer properties and print the document again.
Connect failed: WirelessCard Turn power off, check card.	Wireless LAN card trouble <ul style="list-style-type: none"> • Confirm that there is a Wireless LAN board installed. Check that it is a supported board. If it is, check it is installed correctly. Install the correct board properly
Cover Open. Please close the indicated cover.	Cover is open. <ul style="list-style-type: none"> • Close the cover indicated on the control panel.
Duplex mode is in off position for (tray name)	The duplex mode for the indicated tray is off; you can only use one-sided printing. <ul style="list-style-type: none"> • Press [Change] to change the tray's settings, press [JobReset] to reset the job, or press [Form Feed] to force printing.

1st/2nd Message	Problem/Solution
Ethernet Board Error	An error on the Ethernet board is detected. <ul style="list-style-type: none"> • Pull out and then re-install the controller board.
Failed to connect to server for Remote Diagnostics.	The printer cannot communicate with Remote Communication Gate. <ul style="list-style-type: none"> • Check the connection to the Remote Server Gate.
Independent-supply toner	Independent-supply toner is set. <ul style="list-style-type: none"> • Use toner recommended for this printer.
IPDS font error. Turn power switch off then on. Select Reset IPDS Fonts in Maintenance.	IPDS font error has occurred. <ul style="list-style-type: none"> • Perform the shutdown procedure, and then turn off the power of the machine. Turn on the power again, and then execute [Reset IPDS Fonts].
IPv6 Address already exists Link-local Address(109/209)	The same IPv6 address already exists. <ul style="list-style-type: none"> • Consult your network administrator.
Pv6 Address already exists Stateless Address(109/209)	The same IPv6 address already exists. <ul style="list-style-type: none"> • Consult your network administrator.
Pv6 Address already exists Manual Config. Address(109/209)	The same IPv6 address already exists. <ul style="list-style-type: none"> • Consult your network administrator.
Load paper in (tray name) or [Cancel] to FormFeed.	There is no paper in the specified tray. <ul style="list-style-type: none"> • Load the specified paper in the tray; press [JobReset] to reset the job.
Option RAM Error	The printer cannot detect an optional SDRAM module. It may be incorrectly installed. <ul style="list-style-type: none"> • Check if it is installed properly.
Output tray is full.	The output tray is full. <ul style="list-style-type: none"> • Remove the paper.
Parallel I/F Error	The printer's self diagnostic test failed due to a loopback error. <ul style="list-style-type: none"> • Replace the IEEE 1284 board that caused the error.

1st/2nd Message	Problem/Solution
Prepare Replacement Check print cartridge replacement(s).	The toner has run out, or the photoconductor has reached the end of its service life. <ul style="list-style-type: none"> • Prepare a new AIO.
Printer Font Error.	There are problems with the printer's font file. <ul style="list-style-type: none"> • Check the printer font file.
Problem with Hard Disk Please call service.	The printer cannot detect a hard disk. It may be incorrectly installed. <ul style="list-style-type: none"> • Check if it is installed properly.
Problem:Wireless card Please call service.	The printer cannot detect a wireless LAN board. It may be incorrectly installed. <ul style="list-style-type: none"> • Check if it is installed properly.
Repl Requd Soon:Maint. Kit	You will need to replace the maintenance kit soon. <ul style="list-style-type: none"> • Replace the maintenance kit.
Replace print cartridge. /Print Cartridge replacement is required. (Out of toner)	The toner has run out. <ul style="list-style-type: none"> • Replace the AIO.
Replace print cartridge. /Print Cartridge replacement is required. (Waste Toner Bottle full)	The waste toner bottle is full. <ul style="list-style-type: none"> • Replace the AIO
Replacmnt Requd:Maint. Kit / Maintenance Kit Replacmnt is required. Press Menu key to check Supplies.	You need to replace the maintenance Kit. <ul style="list-style-type: none"> • Obtain a new maintenance kit.
Replace print cartrdg soon./ Toner is almost empty. Contact your local vendor.	The toner is almost depleted. <ul style="list-style-type: none"> • Obtain a new AIO.
SD Card authenticatn. failed Error recurs, call service.	Authentication from the SD card failed. <ul style="list-style-type: none"> • Turn the power off, and then back on.
Set the Fusing Unit correctly.	The fusing unit may not be installed correctly. <ul style="list-style-type: none"> • Turn the printer off and re-install the fusing unit.

1st/2nd Message	Problem/Solution
Set the Print Cartridge correctly.	The AIO may not be installed correctly. <ul style="list-style-type: none"> • Turn the printer off and re-install the AIO.
Supply order has failed.	The automatic supply order failed. The message indicates the supplies that the printer tried to order.
This NetBIOS name is already in use. (108/208)	The NetBIOS name specified for the printer is already in use by another device on the network. <ul style="list-style-type: none"> • Consult your network administrator.
The same IPv4 Address already exists. (102/202)	The IPv4 address specified for the printer is already in use by another device on the network. <ul style="list-style-type: none"> • Consult your network administrator.
The selected job has already been printed or deleted.	This message might appear if you print or delete a job from Web Image Monitor. <ul style="list-style-type: none"> • Press Exit on the message screen.
USB has a problem. Please call service.	The printer has detected a USB board failure. <ul style="list-style-type: none"> • Turn the power off, and then on again.
Values set for IPv6/Gateway addresses are invalid.(110/210)	The IPv6 address or gateway address is invalid. <ul style="list-style-type: none"> • Check the network settings.
WPA Auth. incomplete.(211)	WPA authentication could not complete. <ul style="list-style-type: none"> • Consult your network administrator.

Jam Detection

Paper Jam Display

SP7-507 shows the paper jam history.

- **CODE:** Indicates the jam code.
- **SIZE:** Indicates the paper size code.
- **TOTAL:** Indicates the total counter (SP7-502-001).
- **DATE:** indicates the date when the jam occurred.

Paper Jam Sensors

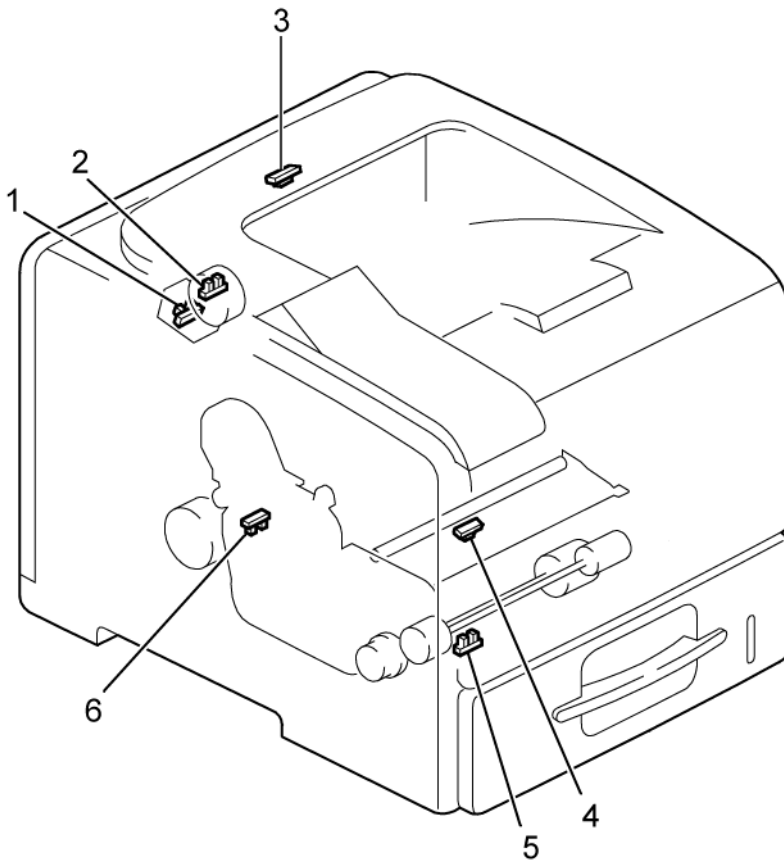

m020v503b

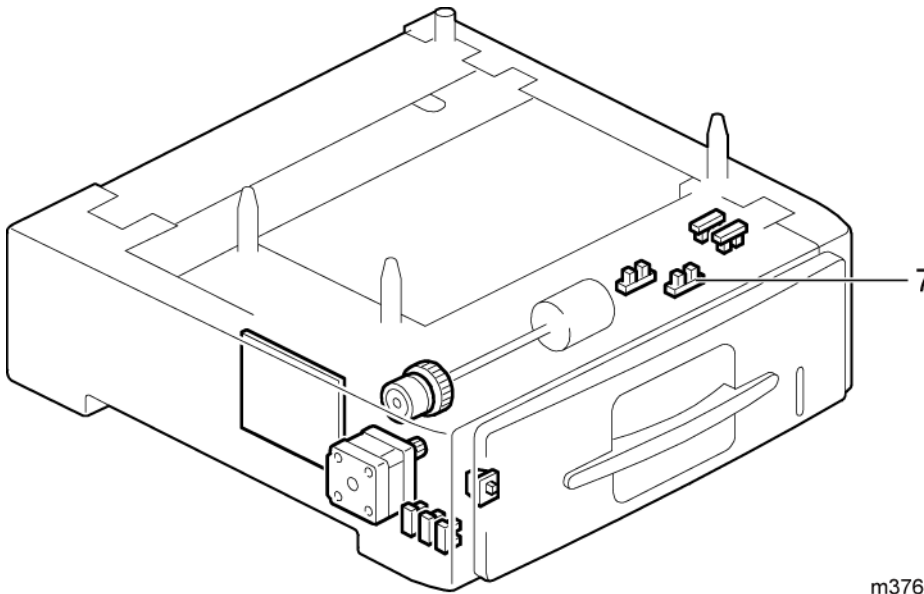

m376d102a

6

1. Duplex entrance sensor
2. Paper overflow sensor
3. Paper exit sensor
4. Registration sensor
5. By-pass paper sensor
6. Duplex relay sensor
7. Vertical transport sensor (Optional paper feed tray)

Jam Codes and Display Codes

Code	Display	Description	LCD Display
0	-	Jam clearance	-
1	See "p.278"	Initial jams (Remainder, cover open, etc.)	See "p.278"
3	PFU1 tray / front cover	Paper is not fed from standard tray (PFU1).	A1
4	PFU2 tray / front cover	Paper is not fed from 1st optional tray (PFU2).	Y1

Code	Display	Description	LCD Display
5	PFU3 tray / front cover	Paper is not fed from 2nd optional tray (PFU3).	Y2
6	PFU4 tray / front cover	Paper is not fed from 3rd optional tray (PFU4).	Y3
7	PFU5 tray / front cover	Paper is not fed from 4th optional tray (PFU5).	Y4
8	By-pass tray / front cover	Paper is not fed from By-pass tray.	A2
9	PFU1 tray / front cover	Paper is not fed from duplex.	Z2
13	PFU3 tray / front cover	1st optional tray sensor does not detect paper.	Y2
14	PFU4 tray / front cover	2nd optional tray sensor does not detect paper.	Y3
15	PFU5 tray / front cover	3rd optional tray sensor does not detect paper.	Y4
17	PFU1 tray / front cover	Registration sensor does not detect paper.	A1
20	Front / rear cover / Fusing unit	Paper exit sensor does not detect paper.	B, C
23	Front / rear cover	Reverse exit sensor does not detect paper.	B, C
27	Rear cover	Duplex relay sensor does not detect paper.	Z1
53	PFU1 / 2 tray, Front cover	1st optional tray sensor does not turn off.	A1, Y1
54	PFU1 / 2 / 3 tray, Front cover	2nd optional tray sensor does not turn off.	A1, Y1, Y2
55	PFU1 / 2 / 3 / 4 tray, Front cover	3rd optional tray sensor does not turn off.	A1, Y1, Y2, Y3
56	PFU1 / 2 / 3 / 4 / 5 tray Front cover	4th optional tray sensor does not turn off.	A1, Y1, Y2, Y3, Y4

Code	Display	Description	LCD Display
57	Front cover	Registration sensor does not turn off.	B
60	Front / rear cover	Paper exit sensor does not turn off.	B, Z1
63	Rear cover	Reverse exit sensor does not turn off.	Z1
67	PFU1 tray, front/rear cover,	Duplex relay sensor does not turn off.	Z1, Z2

Initial Jam Relations

Code	Display	Sensors	LCD Display
1	PFU1 tray / front cover	Standard tray (PFU1) (No sensor)	A1
1	PFU2 tray / front cover	1st optional tray sensor	Y1
1	PFU3 tray / front cover	2nd optional tray sensor	Y2
1	PFU4 tray / front cover	3rd optional tray sensor	Y3
1	PFU5 tray / front cover	4th optional tray sensor	Y4
1	Front cover	Registration sensor	B
1	Front / rear cover	Paper exit sensor	B, Z1
1	Rear cover	Reverse exit sensor	Z1
1	PFU1 tray, front / rear cover	Duplex relay sensor	Z1, Z2

General Troubleshooting

Image Adjustment

Registration Adjustment

Registration is adjusted in the user mode ("Maintenance-Registration"). For details, see the Printer Reference operation manual.

Parallelogram Image Adjustment

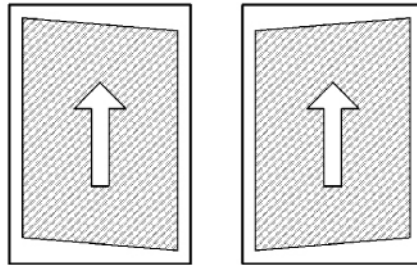
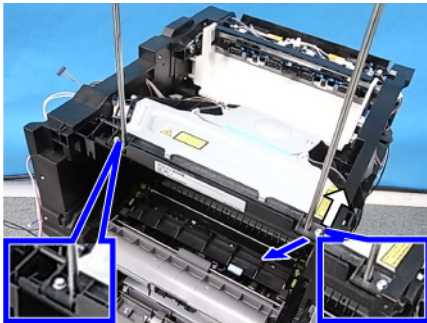

m020i002

Do the following procedure if a parallelogram is printed while adjusting the printing registration using a trimming pattern.

↓ Note

- Use the scanner positioning pin (P/N: A0069104) for this adjustment.
1. Remove the upper cover (See "Upper Cover")
 2. Put a positioning pin in one of the holes
 3. Loosen four screws and move the laser unit.
 4. Tighten the laser unit.
 5. Print the trimming area pattern to check the image. If it is still the same, repeat steps 3 to 5.

Skew Adjustment

Follow the instructions in this flowchart to correct image skew.

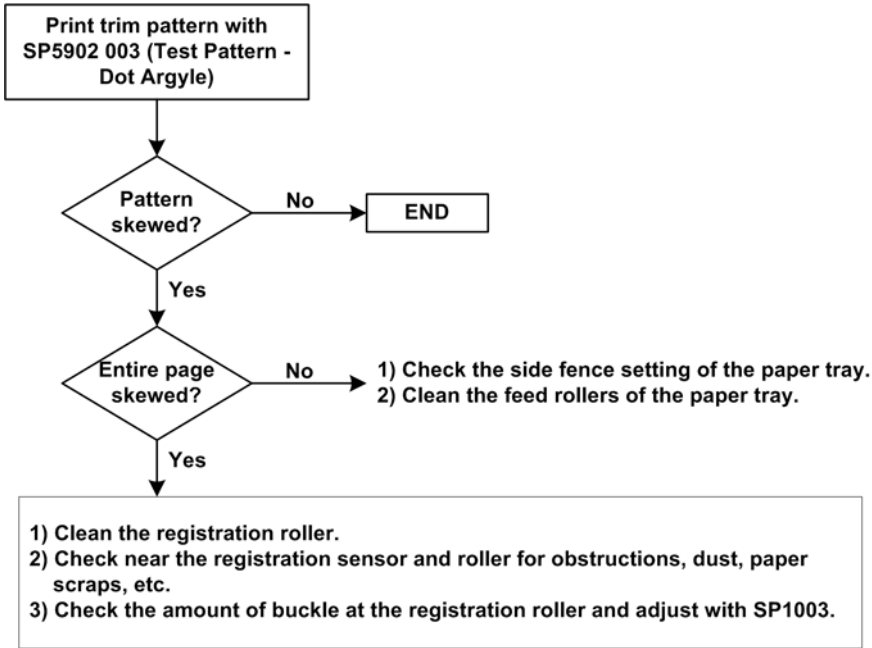

m001r901

Streaks in the Sub Scan Direction

If you see streaks or lines at a regular interval in the sub scan direction:

1. Measure the width of the interval between the streaks.
2. Identify the component in the table below that is causing the problem (based on the size of the measured interval), then inspect that component.

Interval Width (approx.)	Check:
96 mm	OPC Drum (diameter 30.5 mm)
50 mm	Transfer Roller (diameter 16 mm)
117.8 mm	Fusing Roller (diameter 37.5 mm)
113 mm	Pressure Roller(diameter 36 mm)

7. Energy Saving

Energy Save

Energy Saver Modes

Customers should use energy saver modes properly, to save energy and protect the environment.

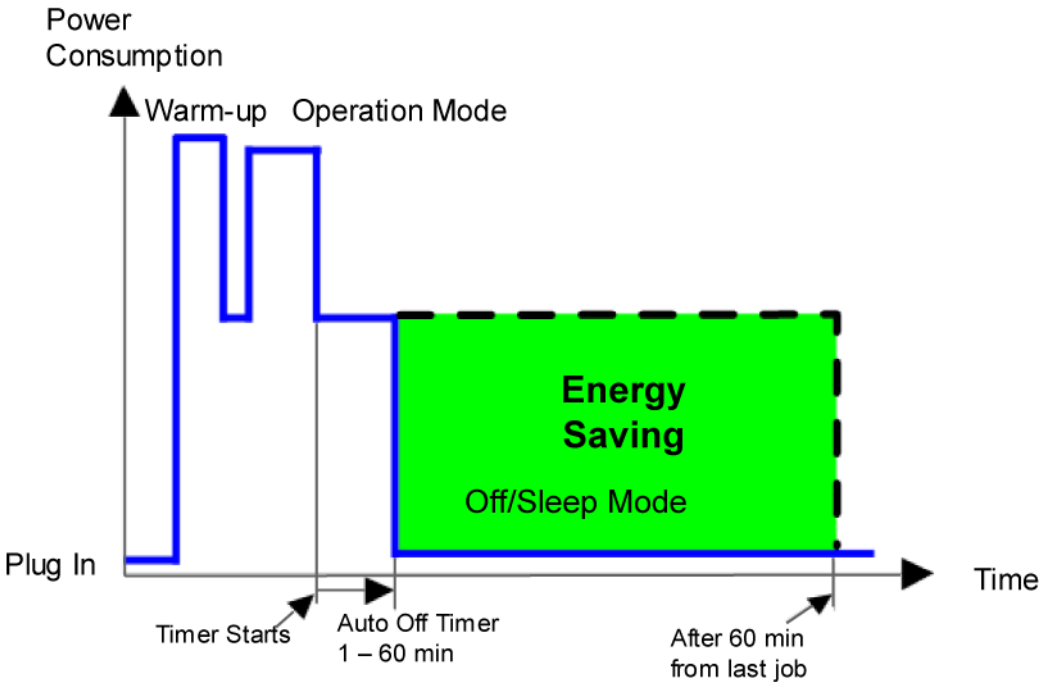

m020i004

When the machine is not being used, the machine enters energy saver mode to reduce the power consumption by turning off the LCD of the operation panel and lowering the fusing temperature.

The green area in this diagram represents the amount of energy that is saved when the timers are at the default settings. If the timers are changed, then the energy saved will be different. For example, if the timers are all set to 60 minutes, the enclosed area will disappear, and no energy is saved before 60 minutes expires.

Power consumption during warm-up may be much higher than shown in this diagram.

Timer Settings

- The user can set this timer with the menu mode (p.237).

1. Press [Menu].
2. Press [▼] or [▲] to scroll through the menu listing and press [OK] to select.
3. [System] > [Auto Off] > [Auto Off On/Off] > [On]
4. [System] > [Auto Off] > [Auto Off Timer] > [1] , [5], [15], [30], [45], [60] min.
5. Press [Escape] to return to the previous menu.
 - The default setting of Auto Off is 1 minute.

Return to Stand-by Mode

Off/Sleep Mode

Recovery time.

- M020/M021: 20 seconds or less.

Recommendation

We recommend that the default settings should be kept.

- If the customer requests that these settings should be changed, please explain that their energy costs could increase, and that they should consider the effects on the environment of extra energy use.
- If it is necessary to change the settings, please try to make sure that the Auto Off timer is not too long. Try with a shorter setting first, such as 5 minutes, then go to a longer one (such as 15 minutes) if the customer is not satisfied.
- If the timers are all set to the maximum value, the machine will not begin saving energy until 60 minutes has expired after the last job. This means that after the customer has finished using the machine for the day, energy will be consumed that could otherwise be saved.
- If you change the settings, the energy consumed can be measured using SP8941, as explained below.

Energy Save Effectiveness

SP 8941 (Machine Status) keeps a record of the amount of time that the machine spends in each mode.

- 8941-001: Operating mode
- 8941-002: Standby mode
- 8941-003: Panel off mode (not used)
- 8941-004: Low power mode (not used)
- 8941-005: Sleep mode

With this data, and the power consumption values from the specifications, we can estimate the amount of energy that is used by the machine.

This should only be used as a reference value, because the power consumption specifications are measured in a controlled environment with a constant power supply.

To get an exact measurement at the customers site, a watt meter must be used to measure the actual energy consumed.

To use SP8941 to calculate the energy consumed:

- At the start of the measurement period, read the values of SP8941 001 to 005.
- At the end of the measurement period, read the values of SP8941 001 to 005 again.
- Find the amount of time spent in each mode (subtract the earlier measurement from the later measurement).
- Multiply this by the power consumption spec for each mode.
- Convert the result to kWh (kilowatt hours)

Here is an example calculation.

Machine Condition	SP8941: Machine Status	Time at Start (min.) ①	Time at End (min.) ②	Running time (hour) $(\text{②} - \text{①}) / 60 = \text{③}$	Power consumption Spec. (W) ④	Power consumption (KWH) $(\text{③} \times \text{④}) / 1000 = \text{⑤}$
Operating	001: Operating Time	21089.0	21386.0	4.95	898	4.45
Stand by (Ready)	002: Standby Time	306163.0	308046.0	31.38	179	5.62
Sleep	005: Off Mode Time	508776.0	520377.0	193.35	1.8	0.35
Total						10.42

Paper Save

Effectiveness of Duplex/Combine Function

Duplexing and the combine functions reduce the amount of paper used. This means that less energy overall is used for paper production, which improves the environment.

1. Duplex

Reduce paper volume in half!



d062d102

7

2. Combine mode

Reduce paper volume in half!



d062d100

3. Duplex + Combine

Using both features together can further reduce paper volume by 3/4!

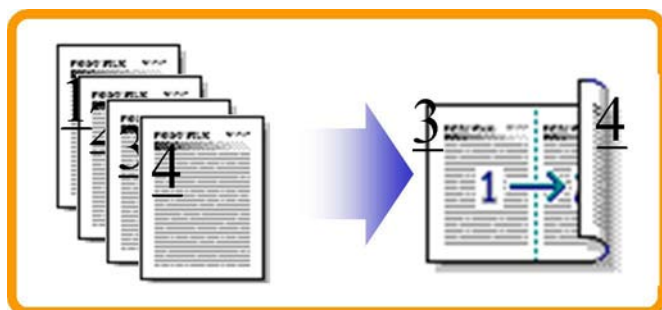

d062d101

To check the paper consumption, look at the total counter and the duplex counter.

The total counter counts all pages printed.

- For one duplex page, the total counter goes up by 2.
- For a duplex job of a three-page original, the total counter goes up by 3.

The duplex counter counts pages that have images on both sides.

- For one duplex page, the duplex counter goes up by 1.
- For a duplex job of a three-page original, the duplex counter will only increase by 1, even though two sheets are used.

How to calculate the paper reduction ratio

How to calculate the paper reduction ratio, when compared with Single-sided copying, with no 2-in-1 combine mode

Paper reduction ratio (%) = Number of sheets reduced: A / Number of printed original images: B x 100

- Number of sheets reduced: A
= Output pages in duplex mode / 2 + Number of pages in Single-sided with combine mode + Number of pages in Duplex with combine mode x 3 / 2

$$A = ((2) / 2 + (3) + (4) \times 3 / 2$$

- Number of printed original images: B
= Total counter + Number of pages in Single-sided with combine mode + Number of pages in Duplex with combine mode

$$B = (1) + (3) + (4)$$

- (1) Total counter: SP 8581 001 (pages)
- (2) Single-sided with duplex mode: SP 8421 001 (pages)
- (3) Single-sided with combine mode: SP 8421 004 (pages)
- (4) Duplex with combine mode: SP 8421 005 (pages)

Model SH-P1
Machine Code: M020/M021
Appendices

29 July, 2011

TABLE OF CONTENTS

1. Appendices: Specifications

- Appendices: Basic Specifications.....3
 - General Specifications.....3
 - External Options.....5
 - Paper Sizes.....6
 - Operating Environment.....9
 - Operation Panel LED Specifications.....9
- Appendices: Controller Specifications.....11
 - Controller Board.....11
 - Printing Functions.....12
 - Printer Drivers.....12
 - Supported Environments.....14
 - Controller Interface Specifications.....17
 - Supported Utilities.....18

2. Appendices: PM Tables

- Maintenance Tables.....21
 - Preventive Maintenance Items.....21
 - Other Yield Parts.....22



1. Appendices: Specifications

Appendices: Basic Specifications

1

General Specifications

Type	Desktop		
Technology	Laser beam scanning and mono-component development electro-photographic printing		
Operation Panel	<ul style="list-style-type: none"> • 4-line display (4 lines x 32 characters/line) • 22 keys, 4 LEDs 		
Resolution (dpi)	1,200 x 600 dpi, 600 x 600 dpi		
Printing Speed	45/50 ppm (A4 - SEF), 47/52 ppm (LT - SEF)		
First Print	7.5 sec or less (A4/LT, SEF, Std. Tray)		
Dimensions (WxDxH)	410 x 435 x 400 mm 16.2 x 17.1 x 15.8 in.		
Weight	Approx. 25 kg / 55 lb. (with std. tray and AIO)		
Input capacity	Standard	Std Tray	550 sheets (80g/m ² , 20lb.)
		By-pass tray	100 sheets (80g/m ² , 20lb.)
	Op. Paper Tray	PFU	550 sheets x 4 (80g/m ² , 20lb.)
	Max	2850 sheets (80g/m ² , 20lb)	
Output capacity	Standard Tray Face down	500 sheets (A4/LT, 80g/m ² , 20lb)	

Input Paper Size	Std. Tray	A4 SEF-A6 SEF, LG SEF-A5 SEFB, Width 98 to 216 mm - Length 140 to 356 mm (Width 3.9 to 8.5 in - Length 5.6 to 14 in.)
	Bypass Tray	A4 SEF-A6 SEF, LG SEF-A6 SEF, Width 64 to 216 mm - Length 140 to 900 mm (Width 2.6 to 8.5 in - Length 5.6 to 14 in.)
	Opt. Tray	A4 SEF-A5 SEF, LG SEF-A5 SEF, Width 98 to 216 mm - Length 160 to 356 mm (Width 3.9 to 8.5 in - Length 6.3 to 14 in.)
Media Type	Std./Opt. Tray, Duplex Unit	Plain Paper, Thick Paper, Recycled Paper, Envelope
	By-pass tray	Plain Paper, Thick Paper, Transparency, Recycled Paper, Envelope
Paper Weight	Standard Tray	52 - 220 g/m ² , 14 - 59 lb.
	Op. Paper Tray	52 - 220 g/m ² , 14 - 59 lb.
	By-pass tray	52 - 220 g/m ² , 14 - 59 lb.
	Duplex tray	60 - 163 g/m ² , 16 - 43 lb.
Warm-up Time	20 sec or less (at 23 deg. C / 71.6 deg. F, no errors)	
Target Yield	Toner (AIO)	25 k prints. Starter: 6 k prints
	Maint. Kit	120 k prints
	Note: 1) An A4 (8.5"x11")/ 5% Chart is used to measure the above yield. 2) The condition is standard temperature and humidity. 3) This yield number may change depending on the circumstances and printing conditions.	
Environment	Off sleep mode	1 min (default)
Safety Standard		US: UL60950, CUL EU: CE Marking, TUV(EN60950)
Environmental Standard		US: Energy Star EU: BAM specifications

Total counter		Electric Counter
@Remote		Supported
HDD		80 GB (M020 option, M021 standard)
RAM	Standard	256 MB (M020)/ 768 MB (M021)
	Maximum	768 MB

External Options

Paper Tray (550 x1) without casters	
Paper Size	A4 SEF-A5 SEF, LG SEF-A5 SEF
Paper Weight	52 - 220g/m ² , 14 - 59 lb.
Paper capacity	550 sheets
Dimensions(w x d x h) (without protuberances)	400 x 445 x 150 mm (15.7 x 17.5 x 5.9 in.)
Weight	7.0 kg or less, 15.5 lb. or less
Paper Tray (550 x 1) with casters	
Paper Size	A4 SEF-A5 SEF, LG SEF-A5 SEF
Paper Weight	52 – 220 g/m ² , 14 - 59 lb.
Paper capacity	550 sheets
Dimensions(w x d x h) (without protuberances)	400 x 445 x 215 mm (29.7 x 28.6 x 8.5 in.)
Weight	8.0 kg or less, 17.7 lb. or less

Paper Sizes

Plain Paper

Type	Orient	Size	Std. Tray	Opt. Tray	Bypass	Env. Feed	Dup.
A4	SEF	210x297 mm	A	A	B	N	A
B5	SEF	182x257 mm	A	A	B	N	A
A5	SEF	148x210 mm	A (NA: B)	A (NA: B)	B	N	A
	LEF	210x148 mm	B	N	B	N	N
B6	SEF	128x182 mm	B	B	B	N	A
A6	SEF	105x148 mm	B	N	B	N	N
Legal	SEF	8 1/2" x 14" mm	A	A	B	N	A
Letter	SEF	8 1/2" x 11" mm	A	A	B	N	A
HLT	SEF	5 1/2" x 8 1/2"	B (NA: A)	B (NA: A)	B	N	A
	LEF	5 1/2" x 8 1/2"	B	N	B	N	N
Exec	SEF	7 1/4" x 10 1/2"	B	B	B	N	A
F	SEF	8" x 13"	B	B	B	N	A
Foolscap	SEF	8 1/2" x 13"	B	B	B	N	A
Folio	SEF	8 1/4" x 13"	B	B	B	N	A

Envelope

Type	Orient	Size	Std. Tray	Opt. Tray	Bypass	Env. Feed	Dup.
Com10	SEF	4 1/8" x 9 1/2"	B	B	B	A	N
Monarch	SEF	3 7/8" x 7 1/2"	B	B	B	A	N

C6	SEF	114 x 162 mm	B	B	B	A	N
C5	SEF	162 x 229 mm	B	B	B	A	N
DL Env	SEF	110 x 220 mm	B	B	B	A	N

Custom

		Std. Tray	Opt. Tray	Bypass	Env. Feed	Dup.
Width	98-216 mm (3.8-8.5 in.)	B	B	/	N	N
Length	140-356 mm (5.5-14 in.)	B	N	/	N	N
	160-356 mm (6.3-14 in.)	N	B	N	N	A
Width	64-216 mm (2.5-8.5 in.)	/	/	B	N	N
Length	140-900 mm (5.5-35 in.)	/	/	B	N	N

Papers:

A	Supported and the size is automatically detected.
B	Need to input paper size by operation panel and driver.
C	Need to specify the paper size by the SP mode.
N	Not supported.
/	Does not apply

Duplex:

A	Paper feed possible
N	Paper feed impossible

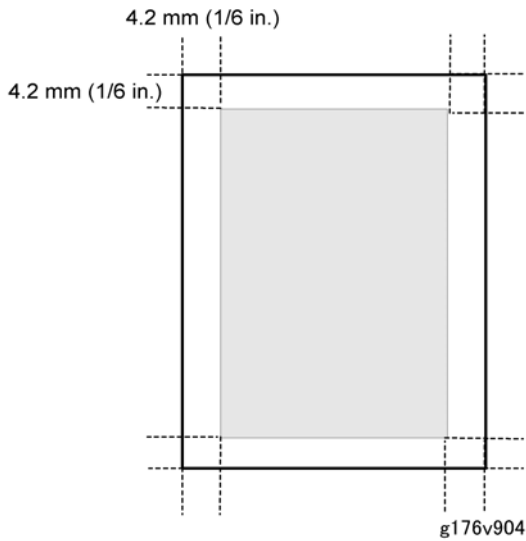

Note

- The printable area may vary depending on paper size, printer language and printer driver settings.

Envelopes

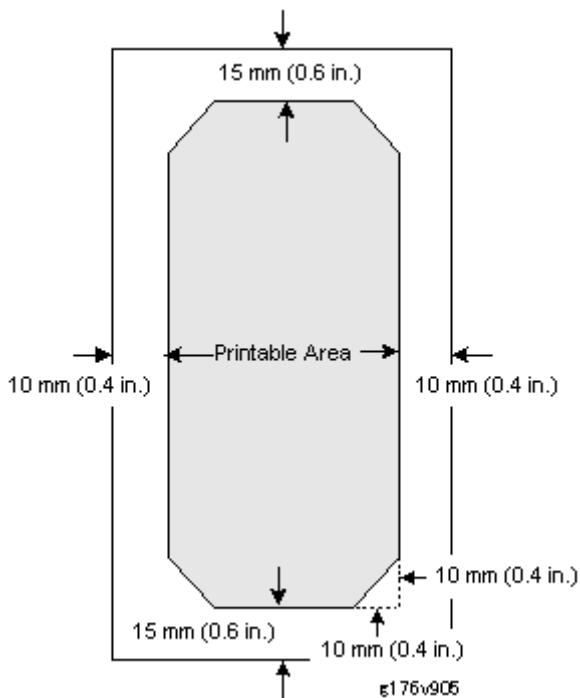

Operating Environment

Power Source	North America: 120 - 127 V, 60 Hz 11 A or less		
	Europe: 220 - 240 V, 50/60 Hz 6 A or less		
Power Consumption	Maximum	Main Unit	Full System
		1,400 W or less	1,400 W or less
	Off/Sleep mode	5 W or less	5 W or less
Noise Emission	Printing	M020: 71.8 dB or less M021: 72 dB or less	M020: 75.8 dB or less M021: 76 dB or less
	Standby	M020: 46.5 dB or less M021: 48 dB or less	M020: 46.5 dB or less M021: 48 dB or less
Sound Pressure Level (All Models) (Operating Position)	Printing	M020: 65.8 dB or less M021: 66 dB or less	M020: 69.8 dB or less M021: 70 dB or less
	Standby	M020: 40.5 dB or less M021: 42 dB or less	M020: 40.5 dB or less M021: 42 dB or less

Operation Panel LED Specifications

LED	Color	Appearance	Meaning
-----	-------	------------	---------

Power	Blue	Off	Power off or in Energy Saver mode
		Flashing	Warming up
		On	Power on and not in Energy Saver mode
Data In	Blue	Off	No data
		Flashing	Data being received or processed or the printer is spooling
		On	Data being received or processed; more data coming
Suspend/ Resume	Blue	Off	Ready to print
		On	Suspend
Error	Red / yellow	Off	No messages or error conditions requiring attention
		Red On	Printing is not possible, or printing quality cannot be ensured
		Yellow Flashing	Printer requires service

Appendices: Controller Specifications

Controller Board

1

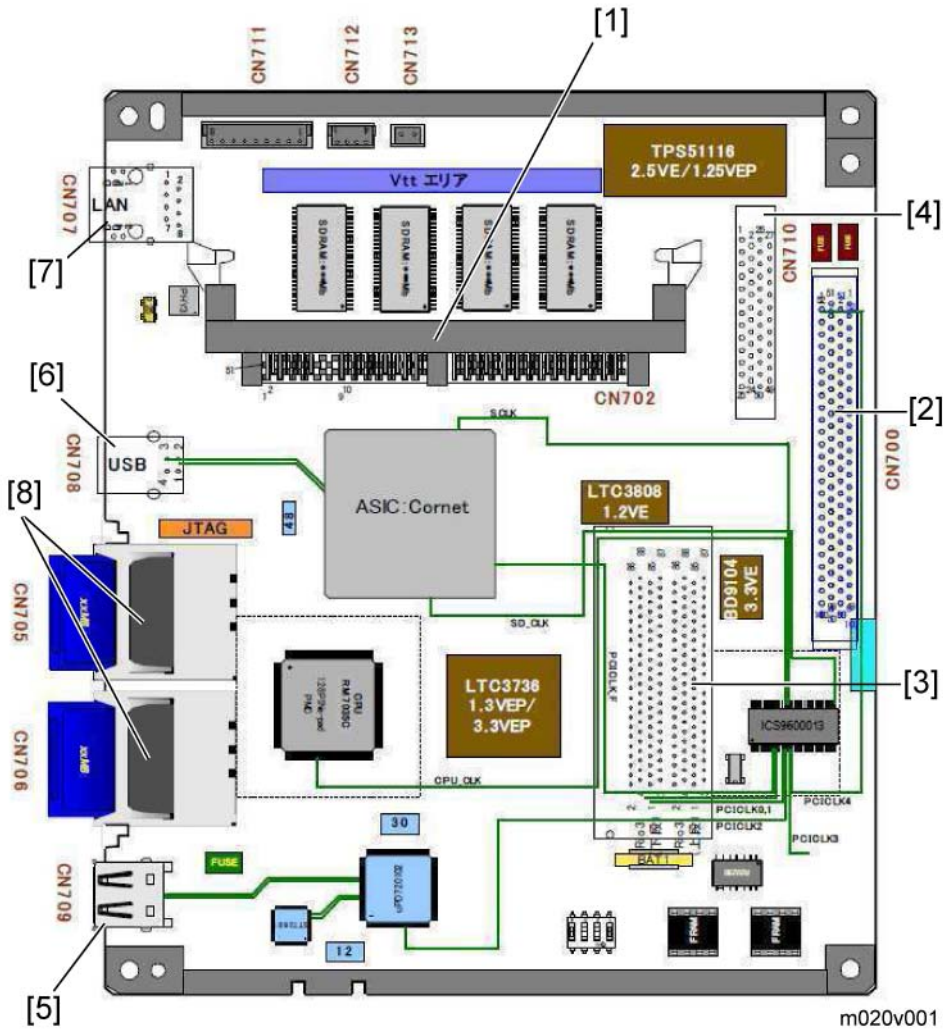

1. DDR DIMM I/F
2. Engine I/F
3. PCI Option
4. HDD I/F
5. USB Host I/F
6. USB I/F
7. LAN I/F
8. SD Card I/F (Slots x2)

Printing Functions

Job Spool	Y
Adjustment Registration	Y
Adjustment Image Density	Y
* With HDD	

Printer Drivers

Item	PCL6	PCL5e	PostScript3			XPS
			Windows	Mac		
			XP/ Vista/7	OS 8.6 or later	OSX	
Job Binding	N	N	N	N	N	N
Send to Document Server	N	N	N	N	N	N
Sample Print	Y	Y	Y	Y	Y	Y
Locked Print	Y	Y	Y	Y	Y	Y
Reduce/Enlarge (Scaling)	N	N	Y	Y	Y	Y

Reduce/Enlarge Centering	Y	Y	N	N	N	N
Collate	Y	Y	Y	Y	Y	Y
Layout (N-up)	Y	Y	Y	Y	Y	Y
Poster	N	N	N	Y	N	N
Duplex	Y	Y	Y	Y	Y	Y
Punch	N	N	N	N	N	N
Staple	N	N	N	N	N	N
Front Cover Sheet	Y	Y	N	Y	Y	N
Front and Back Cover Sheets	N	N	N	N	N	N
Slip Sheet	Y	Y	N	N	N	Y
Chaptering (Page Layout)	N	N	N	N	N	N
Chaptering (Single Page Insert)	N	N	N	N	N	N
Chaptering (Page Block Insert)	N	N	N	N	N	N
User Defined Pages	N	Y	N	N	N	N
Tab Stock Printing	N	N	N	N	N	N
Mirror Image Print	N	N	Y	N	N	N
Negative Image Print	N	N	Y	N	N	N
Dithering	N	N	Y	Y	Y	N
Edge Smoothing	Y	Y	Y	Y	Y	N
Toner Saving	Y	Y	Y	Y	Y	Y
Watermark	Y	Y	Y	Y	Y	N
Form Overlay	N	N	N	N	N	N
Header/Footer	N	N	N	N	N	N

Adjust image position	N	N	N	N	N	N
Binding Margins	N	N	N	N	N	N
User ID	Y	Y	Y	N	N	Y
User Code	Y	Y	Y	N	N	Y
Rotate Print	Y	Y	Y	N	N	Y
Reverse Order Print	N	N	Y	Y	Y	Y
Do not print Blank pages	N	N	N	N	N	N
Edge to Edge Print	Y	Y	Y	Y	Y	N

Supported Environments

Windows Environments

Windows OS	Type	PCL5e	PCL6	PS3	XPS
Win XP	Professional	Yes	Yes	Yes ^{*1}	No
	Home Ed.	Yes	Yes	Yes ^{*1}	No
Win Server 2003/2003R2	Standard Ed.	Yes ^{*2}	Yes ^{*2}	Yes ^{*1*2}	No
	Enterprise Ed.	Yes ^{*2}	Yes ^{*2}	Yes ^{*1*2}	No
	Datacenter Ed.	No	No	No	No
	Web Ed.	No	No	No	No
Vista	Home Ed.	Yes	Yes	Yes	Yes ^{*3}
	Premium Ed.	Yes	Yes	Yes	Yes ^{*3}
	Business Ed.	Yes	Yes	Yes	Yes ^{*3}
	Enterprise Ed.	Yes	Yes	Yes	Yes ^{*3}
	Ultimate Ed.	Yes	Yes	Yes	Yes ^{*3}

Win Server2008	Standard Ed.	Yes	Yes	Yes	Yes
	Enterprise Ed.	Yes	Yes	Yes	Yes
	Datacenter Ed.	No	No	No	No
Win Server2008 R2	Standard Ed.	Yes	Yes	Yes	Yes
	Enterprise Ed.	Yes	Yes	Yes	Yes
	Datacenter Ed.	No	No	No	No
Win 7	Home Ed.	No	No	No	No
	Starter Ed.	No	No	No	No
	Premium Ed.	Yes	Yes	Yes	Yes
	Professional Ed.	Yes	Yes	Yes	Yes
	Enterprise Ed.	Yes	Yes	Yes	Yes
	Ultimate Ed.	Yes	Yes	Yes	Yes

Notes

*1	Adobe does not release PS driver for Windows XP. Only MS-PostScript driver is available and PPD file for MS-PS is included in the Driver CD.
*2	Cluster function is not supported.
*3	Service Pack 1 or later is recommended

Mac OS Environments

Mac OS	PS3	Printer Utility for MAC
Mac OS 8.6 - 9.2.X (OS X Classic)	Y	Y
Mac OS X Native (v. 10.1 or Later) *1	Y	Y*2

Notes

- *1 Mac OS X v.10.0.X is not supported. Plug-in function for "Sample Print", "Locked Print" and "User Code" is supported from Mac OS X 10.2 and later.

*2 Mac OS X v.10.2.0 is not supported.

1

UNIX Environment

Supported Platforms	Network Installation	Device Option Support*
Sun Solaris	2.6 / 7 / 8 / 9 / 10	2.6 / 7 / 8 / 9 / 10
HP-UX	10.X / 11.X / 11iv2	10.X / 11.X / 11iv2
SCO OpenServer	5.07 , 6.0	5.07 , 6.0
RedHat Linux	6.X / 7.X / 8.X / 9.X / Enterprise	6.X / 7.X / 8.X / 9.X / Enterprise
IBM AIX	V4.3 / 5L V5.1 / 5L V5.2 / 5L V5.3	V4.3 / 5L V5.1 / 5L V5.2 / 5L V5.3
Data Stream	PostScript, PCL, ASCII	
Localization	English only	
* Device Option feature is not supported in PCL.		

Novell Netware

Netware Server	Supported Version	Netware 3.12, 3.2, 4.1, 4.11, 5.0, 5.1, 6 , 6.5
	Client OS	Windows XP(professional) /Vista
NDPS Gateway (V4 Release)	Supported Server OS	NetWare 5.1 with SP7 or later, 6.0 with SP4 or later, 6.5
	Supported Client OS	Microsoft Windows XP Professional with Novell Client 4.83 or later *Windows XP Home Edition is not supported since Novell Client does not support this OS.
	Localization	English, German, French, Italian, Spanish

SAP R/3 Environment

Supported environment	R/3 version	3.x or later (4.x = Supported, 3.x, 6.x = Compatible)
	Platform	Independent
	PDL	PCL5e
	Character Set	Latin 1 (Western European), Latin 2 (Eastern European)
	Localization	English only
Supported features	i.e: Input/Output Bin, Duplex, Stapling, Punching, Resolution, Collation, EconoMode/TonerSaving, Smoothing, Page Protect, Auto Tray Change/Opt Tray select	
Supported Barcode & OCR Fonts*	Barcode Fonts (Support Latin 1 only)	Code 128, Code 39, Code 93, Codebar, 2 of 5 interleaved/Industrial/Matrix, MSI, USPS, UPC/EAN
	OCR Fonts	OCR A, OCR B
* Need to purchase Barcode & OCR Package		

Controller Interface Specifications

Network Interface (Standard)	
Data Transmission Speed	10M bps, 100 Mbps
Protocol	TCP/IP, IPX/SPX, Bonjour
Supported OS	Windows XP/Vista/7, Windows Server2003/2003R2/2008, Mac OS
Distance between devices	100m
USB 2.0 Interface (Standard)	
Data Transmission Speed	480 Mbps (High Speed:USB 2.0), 12 Mbps (Full Speed)
Supported OS	Windows XP/Vista/7

IEEE 1284 Interface (Option)	
Data Transmission Speed	Compatible/Nibble/Byte/ECP mode
Supported OS	Windows XP/Vista/7/Server2003, Mac OS
Distance between devices	2.5m
Wireless LAN Interface (Option)	
Data Transmission Speed	11 Mbps, 5.5 Mbps, 2 Mbps, 1 Mbps
Protocol	TCP/IP, IPX/SPX, SMB, AppleTalk
Supported OS	Windows XP/Vista/7, Windows Server2003/2003R2/2008, Mac OS
Distance between devices	140m (11 Mbps), 200m (5.5 Mbps), 270 m (2 Mbps), 400 m (1 Mbps)
Frequency	From 2,400 MHz to 2,497 MHz
Channel	1-11 ch (US model), 1-13 ch (EU model)
Type of connection	Ad hoc mode, 802.11b Ad hoc mode, Infrastructure mode, WPA
Gigabit Ethernet (Option)	
Data Transmission Speed	10M bps, 100 Mbps, 1000 Mbps
Protocol	TCP/IP, IPX/SPX, SMB, AppleTalk
Supported OS	Windows XP/Vista/7, Windows Server2003/2003R2/2008, Mac OS
Distance between devices	100m

Supported Utilities

Bundled Utilities

No.	Utility Name	Supported?
1	Printer Utility for Mac	No

2	Font Manager 2000	YES
3	WebImageMonitor (embedded web server)	YES

Optional Utilities

No.	Utility Name	Supported?
1	DeskTopBinder Lt	YES
2	Remote Communication Gate S Pro	YES
3	Smart Device Monitor for Admin Accounting Report Pack	YES

2. Appendices: PM Tables

Maintenance Tables

Preventive Maintenance Items

To enable the machine for maintenance by the service technician, the meter-charge mode must be set to "enabled" with SP5930 and "0: Service" with SP5-067-001.

The table below shows the PM items serviced by the service technician.

After completing a PM procedure, reset the PM counter for the replaced part with SP7-804.

Mainframe

Paper

Chart: A4 (LT)/5%

Mode: 2 copies / original (prints/job)

Ratio 25%

Environment: Normal temperature and humidity

Yield may change depending on circumstances and print conditions.

Symbol keys: C: Clean, R: Replace, L: Lubricant, I: Inspect

Item	6/25 K	120 K	EM	Remarks
PCDU				
AIO	R	-	-	
Transfer				
Transfer Roller	-	R	-	
Fusing				
Fusing Unit	-	R	-	
Paper Path				
Paper Feed Roller	-	R	C	Damp cloth
Friction Pad	-	R	C	Dry cloth

Item	6/25 K	120 K	EM	Remarks
Registration Roller	-	-	C	Damp cloth
Dust Shield Glass	-	-	C	Optical cloth, Blower

2

Other Yield Parts

The parts mentioned in these tables have a target yield. However, the total copy/print volume made by the machine will not reach the target yield within the machine's targeted lifetime if the machine is used under the target usage conditions (ACV, color ratio, P/J, and C/O). So, these parts are categorized not as PM parts but as yield parts (EM parts).

One-tray Paper Feed Unit (M386/M389)

Item	EM	Remarks
Feed Roller	C	Dry cloth
Separation Roller	C	Dry cloth
Pick-up Roller	C	Dry cloth
Relay Roller	C	Damp cloth
Bottom Plate Pad	C	Damp cloth
Sensors	C	Blower brush